

Better Solution for Chromatography

- | HPLC/GC 컬럼 | 시린지필터 | 바이알 & 캡 |
- | HPLC 밀폐안전시스템 | 피펫 | SPE시스템 |
- | 피팅 | 튜빙 | 인젝터 | 시린지 | HPLC펌프 |
- | 전처리장비 | 기초장비 | HPLC/GC 소모품 |



레보딕스(주) 홈페이지에
방문하시면 더욱 다양한
제품을 보실 수 있습니다!

REVODIX
레보딕스(주)

[REVODIX 카탈로그 구성도]

Laboratory Product

Liquid Fluidic Product

All That Laboratory

Summary Version _ 48 page

기초·분석장비, 챔버, 미생물장비,
초순수제조장치, 실험실 소모품



All That Pump

_ 152 page

튜브펌프, 기어펌프, 시린지펌프, 피스톤펌프,
다이아프램펌프, OEM펌프

All That Pump

Summary Version _ 28 page

전체 카탈로그

그룹별 카탈로그



Better Solution for Lab Instruments

_ 116 page

건조기, 배양기, 오토클레이브,
BSC, 냉장·냉동고, 초저온냉동고,
안전캐비닛, 초순수제조장치, 회화로



Better Solution for Basic Science

_ 52 page

교반기, 균질기, 향온수조, 믹서,
초음파세척기, 히팅 블록,
pH 미터, 분광 광도계, 피펫

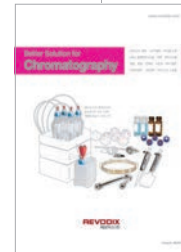

Better Solution for Chromatography

_ 192 page

HPLC/GC컬럼, 시린지필터,
바이알&캡, 피펫, 튜빙,
밀폐안전시스템, 전처리장비

메이커 카탈로그



MMM (Germany)
_ 4page

안정성 테스트 챔버



Froilabo (France)
_ 4page

초저온 냉동고
(-45 °C, -86 °C)



REVOTRAK (레보트랙)
_ 4page

온습도 중앙 모니터링
시스템



LSS (Italy)
_ 6page

인화성·화학물질
보관 캐비닛



POLYSCIENCE (USA)
_ 16page

향온순환수조, 칠러



Fiocchetti (Italy)
_ 2page

실험실, 병원용 냉장고,
냉동고

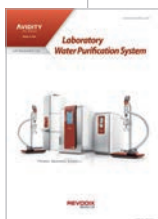

AVIDITY
_ 12page

초순수제조장치



PALL (USA)
_ 6page

시린지 필터,
멤브레인 필터



LABPLAS (Canada)
_ 20page

멸균 샘플백

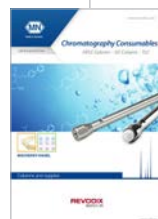

MN (Germany)
_ 240page

HPLC & GC 컬럼, TLC



SCAT (Germany)
_ 172page

안전 캡, 안전 폐액 캡,
갈매기



Oxford (USA)
_ 8page

매뉴얼 피펫, 전자피펫,
피펫 컨트롤러

* 카탈로그를 원하시면 연락 주시기 바랍니다. (TEL : 031-790-1907)

CONTENTS

1 _ Column & SPE System



HPLC Column

- USP Listing 10
- NUCLEOSIL® phase overview 12
- NUCLEOSIL® Column 15
- NUCLEODUR® phase overview 24
- NUCLEODUR® Column 30
- NUCLEOSHELL® phase overview 42
- NUCLEOSHELL® Column 44

GC Column

- USP Listing 48
- OPTIMA® phase overview 50
- OPTIMA® Column 56

Others

- TLC 70
- SPE Column 72
- QuEChERS 73
- Automated SPE System 74

2 _ Sample Preparation



- Syringe Filter | Membrane Filter 80
- Filter Funnel | Solvac Filter Holder 82
- Vacuum Pump 83
- Vial & Cap 84
- Pipette (Manual / Electronic) 88
- Pipette Aid | Bottle Top Dispenser 91
- Bottle Cap 92
- Solvent Filter 93
- Safety Cap 94
- Safety Waste Cap 96
- Exhaust Filter 99
- Safety Funnel 100
- Water Purification System 102



3 _ Injection Part | Column Accessories

- Manual Injector / Automatic Valve (Rheodyne) 108
- UHPLC Connection System 112
- Fitting 113
- Connector 116
- Tubing 118
- Column Accessories 122
- HPLC Accessories 124
- GC Accessories 126
- Syringe 132



4 _ HPLC Pump & Detector Accessories

- Check Valve 140
- Piston Seal | Piston 148
- Lamp 156



5 _ Pump | Degasser

- Dual Piston Pump 160
- Single Piston Pump 162
- Degasser 163



6 _ REVODIX Lab Equipment

- Chamber & Storage 168
- Autoclave 172
- Laboratory Safety 174
- Basic Equipment 177
- Food Analyzer 183
- Microbiology Instrument 184
- Tablet Tester 186
- Measuring Instrument 187
- Water Analyzer 188
- Laboratory Consumable 190

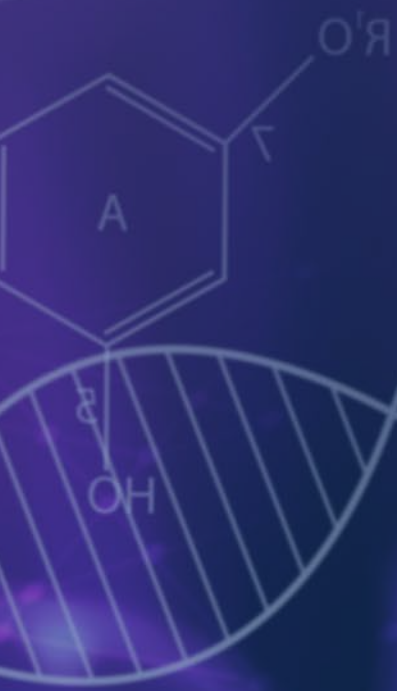

Column & SPE System



HPLC Column

USP Listing.....	10
NUCLEOSIL® phase overview	12
NUCLEOSIL® Column	15
NUCLEODUR® phase overview	24
NUCLEODUR® Column.....	30
NUCLEOSHELL® phase overview	42
NUCLEOSHELL® Column	44

GC Column

USP Listing.....	48
OPTIMA® phase overview.....	50
OPTIMA® Column	56

Others

TLC	70
SPE Column	72
QuEChERS	73
Automated SPE System	74



MACHEREY-NAGEL (since 1911)

MACHEREY-NAGEL은 1911년 독일에서 크로마토그래피 소모품 전문 업체로 설립되었습니다.

100여년 이상 오랜 역사를 지닌 MACHEREY-NAGEL은 크로마토그래피 시장의 선두주자로 자리매김 하였습니다.

대표 제품인 NUCLEOSIL® Column은 전세계적으로 연구 및 분석 실험에 범용적으로 사용되고 있으며, 최근 UHPLC 산업이 성장함에 따라 NUCLEODUR®, NUCLEOSHELL® 제품 라인이 추가 되었습니다.

산업, 의료, 생명 공학, 환경 분석 및 연구 등 다양한 분야에서 사용 가능한 MACHEREY-NAGEL Column을 레보딕스(주)에서 만나보세요.

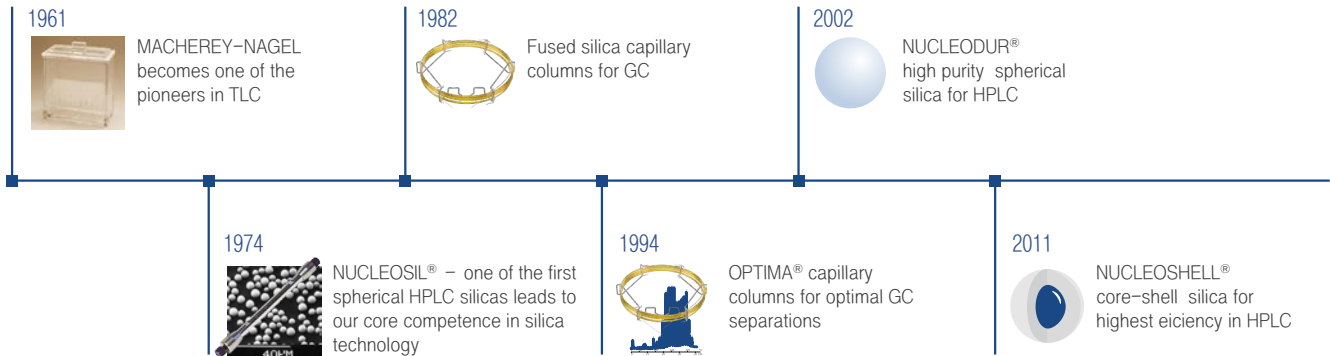

Quality & Service

- 신뢰할 수 있는 고품질 제품으로 우수한 재현성 보장
- 크로마토그래피 전문가 팀이 제공하는 자문 지원
- 개별 요구 사항에 따라 유연하고 맞춤형 솔루션 제공
- 3,000개 이상의 다양한 어플리케이션 DATABASE : www.mn-net.com/apps

Strict quality specifications Outstanding reliability

Highest production standard

- Our facilities are ISO 9001 certified
- Perfect reproducibility from batch-to-batch and within each lot
- Individually tested columns, supplied with test chromatogram and conditions



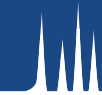

HPLC / GC Column



HPLC Column

Model	Key Features	Spherical silica gels	page
NUCLEOSIL®	<p>분석 실험에 범용적으로 사용되는 MN사 대표 HPLC column</p> <ul style="list-style-type: none"> 40여년 이상 HPLC에서 최고 품질을 보장하는 컬럼 균일한 silica 구조로 광범위한 어플리케이션에 적용 가능 다양한 고정상 제공 		12~23 page
NUCLEODUR®	<p>완벽한 구형 및 Smooth한 표면구조 silica로 고압에 안정적인 분리능</p> <ul style="list-style-type: none"> 완전합성의 Type B 3세대 silica 뛰어난 표면 미세구조 낮은 메탈 함량의 고순도 silica사용으로 tailing 없는 대칭 형태의 peak 		24~41 page
NUCLEOSHELL®	<p>Solid core 위에 균질한 silica shell을 입힌, 최신의 Core-shell technology</p> <ul style="list-style-type: none"> 일반 silica 구조에 비해 짧은 diffusion path로 sharp한 peak 가능 Shell 구조를 통한 빠른 유속과 분리능 확보로 고압의 UHPLC에 최적 전체 다공성 입자 컬럼 대비 더 큰 처리량과 더 빠른 분리시간 제공 		42~45 page



GC Column

Model	Key Features	GC cages	page
OPTIMA®	<p>고온 조건에서 뛰어난 안정성을 가지는 MN사 대표 GC column</p> <ul style="list-style-type: none"> 우수한 분리능 및 다양한 선택성 안정성 및 재현성이 뛰어나 신뢰할 수 있는 결과 산출 고온에서도 낮은 Bleed 	<p>7 inches standard / 5 inches special cage</p>	49~68 page

Compatibility with Other Manufacturers



HPLC Column

MACHEREY-NAGEL		Agilent		Waters		Phenomenex	
P/N	제품명	P/N	제품명	P/N	제품명	P/N	제품명
720014.46	NUCLEOSIL 100-5 C18, EC 250mm, 4.6mm, 5 µm	959990-902	ZORBAX Eclipse Plus C18, 250mm, 4.6mm, 5 µm	186002560	SunFire C18 Column, 250mm, 4.6mm, 5 µm	00G-4252-E0	LUNA C18, 250mm, 4.6mm, 5 µm
760101.46	NUCLEODUR C18 Gravity EC 250mm, 4.6mm, 5 µm	770995-092	ZORBAX Extend 300 C18, 250mm, 4.6mm, 5 µm	186003117	XBridge BEH C18 Column, 250mm, 4.6mm, 5 µm	00G-4435-E0	GEMINI C18, 250mm, 4.6mm, 5 µm
763257.46	NUCLEOSHELL RP 18plus, EC 250mm, 4.6mm, 5 µm	A2000250C046	Polaris C18, 250mm, 4.6mm, 5 µm			00G-4601-E0	Kinetex C18, 250mm, 4.6mm, 5 µm
720120.46	NUCLEOSIL 100-5 C18, EC 150mm, 4.6mm, 5 µm	773995-902	ZORBAX Extend 300 C18, 150mm, 4.6mm, 5 µm	186002559	SunFire C18 Column, 150mm, 4.6mm, 5 µm	00F-4252-E0	LUNA C18, 250mm, 4.6mm, 5 µm
760103.46	NUCLEODUR C18 Gravity, EC 150mm, 4.6mm, 5 µm	959993-902	ZORBAX Eclipse Plus C18, 150mm, 4.6mm, 5 µm	186003116	XBridge BEH C18 Column 150mm, 4.6mm, 5 µm	00F-4435-E0	GEMINI C18, 150mm, 4.6mm, 5 µm
763136.46	NUCLEOSHELL RP 18, EC 150mm, 4.6mm, 2.7 µm	A2001150C046	Polaris C18, 150mm, 4.6mm, 3 µm	186008685	CORTECS Shield RP18 150mm, 4.6mm, 2.7 µm	00F-4462-E0	Kinetex C18, 150mm, 4.6mm, 2.6 µm



GC Column

MACHEREY-NAGEL		Agilent		Phenomenex	
P/N	제품명	P/N	제품명	P/N	제품명
726050.3	OPTIMA® 1 30 m × 0.25 mm, 0.25 µm	122-1032	J&W DB-1 30 m × 0.25 mm, 0.25 µm	7HG-G001-11	ZB-1 30 m × 0.25 mm, 0.25 µm
726056.3	OPTIMA® 5 30 m × 0.25 mm, 0.25 µm	122-1932	DB-35 30 m × 0.25 mm, 0.25 µm	7HG-G003-11	ZB-35 30 m × 0.25 mm, 0.25 µm

USP Listing



USP specification of MN HPLC Phases

Code	Specification	MN HPLC Phases
USP L1	octadecyl silane chemically bonded to porous silica particles 1.5 to 10 µm diameter, or monolithic silica gel	NUCLEODUR® C ₁₈ ec
		NUCLEODUR® C ₁₈ Gravity
		NUCLEODUR® C ₁₈ Gravity-SB
		NUCLEODUR® C ₁₈ HTec
		NUCLEODUR® C ₁₈ Isis
		NUCLEODUR® C ₁₈ PAH
		NUCLEODUR® C ₁₈ Pyramid
		NUCLEODUR® PolarTec
		NUCLEODUR® Sphinx RP
		NUCLEOSHELL® RP 18
		NUCLEOSHELL® RP 18plus
		NUCLEOSIL® C ₁₈
		NUCLEOSIL® C ₁₈ AB
		NUCLEOSIL® C ₁₈ HD
		NUCLEOSIL® C ₁₈ MPN
NUCLEOSIL® C ₁₈ PAH		
NUCLEOSIL® C ₁₈ PPN		
USP L3	porous silica particles, 1.5 to 10 µm diameter, or monolithic silica gel	NUCLEODUR® SiOH
		NUCLEOSIL® SiOH
USP L7	octyl silane chemically bonded to totally porous silica particles, 1.8 to 10 µm diameter	NUCLEODUR® C ₈ ec
		NUCLEODUR® C ₈ Gravity
		NUCLEOSIL® C ₈
		NUCLEOSIL® C ₈ HD
USP L8	an essentially monomolecular layer of aminopropyl silane chemically bonded to totally porous silica gel support, 1.5 to 10 µm diameter	NUCLEODUR® NH ₂ / NH ₂ -RP
		NUCLEOSIL® Carbohydrate
		NUCLEOSIL® NH ₂ / NH ₂ -RP
USP L9	irregular or spherical, totally porous silica gel having a chemically bonded, strongly acidic cation-exchange coating, 3 to 10 µm diameter	NUCLEOSIL® SA
USP L10	nitrile groups chemically bonded to porous silica particles, 1.5 to 10 µm diameter	NUCLEODUR® CN / CN-RP
		NUCLEOSIL® CN / CN-RP

USP Listing



USP specification of MN HPLC Phases

Code	Specification	MN HPLC Phases
USP L11	phenyl groups chemically bonded to porous silica particles, 1.5 to 10 µm diameter	NUCLEODUR® Phenyl-Hexyl
		NUCLEODUR® π ²
		NUCLEOSHELL® Phenyl-Hexyl
		NUCLEODUR® Sphinx RP
		NUCLEOSIL® C ₆ H ₅
USP L14	silica gel having a chemically bonded, strongly basic quaternary ammonium anion-exchange coating, 5 to 10 µm diameter	NUCLEOSIL® SB
USP L16	dimethylsilane chemically bonded to porous silica particles, 5 to 10 µm diameter	NUCLEOSIL® C ₂
USP L17	strong cation-exchange resin consisting of sulfonated cross-linked PS/DVB copolymer in the H form, 6 to 12 µm diameter	NUCLEOGEL® ION 300 OA
		NUCLEOGEL® SUGAR 810 H
USP L19	strong cation-exchange resin consisting of sulfonated cross-linked PS/DVB copolymer in the Ca form, 5 to 15 µm particle size	NUCLEOGEL® SUGAR 810 Ca
		NUCLEOGEL® SUGAR Ca
USP L20	dihydroxypropane groups chemically bonded to porous silica particles, 5 to 10 µm diameter	NUCLEOSIL® OH (Diol)
USP L21	a rigid, spherical styrene-divinylbenzene copolymer, 5 to 10 µm diameter	NUCLEOGEL® RP
USP L22	a cation-exchange resin made of porous polystyrene gel with sulfonic acid groups, about 10 µm in size	NUCLEOGEL® SCX
USP L23	an anion-exchange resin made of porous polymethacrylate or polyacrylate gel with quaternary ammonium groups, about 10 µm in size	NUCLEOGEL® SAX
USP L26	butyl silane chemically bonded to totally porous silica particles, 5 to 10 µm diameter	NUCLEODUR® C ₄ ec
		NUCLEOSIL® C ₄
		NUCLEOSIL® C ₄ MPN
USP L32	a chiral ligand-exchange resin packing · L-proline copper complex covalently bonded to irregular shaped silica particles, 5 to 10 µm diameter	NUCLEOSIL® CHIRAL-1
USP L34	strong cation-exchange resin consisting of sulfonated cross-linked PS-DVB copolymer in the Pb form, 5 to 7 µm particle size	NUCLEOGEL® SUGAR Pb
USP L36	a 3,5-dinitrobenzoyl derivative of L-phenylglycine covalently bonded to 5 µm aminopropyl silica	NUCLEOSIL® CHIRAL-3
USP L40	cellulose tris- (3,5-dimethylphenylcarbamate) coated porous silica particles, 5 to 20 µm diameter	NUCLEOCEL DELTA
USP L43	pentafluorophenyl groups chemically bonded to silica particles by a propyl spacer, 1.5 to 10 µm diameter	NUCLEODUR® PFP
		NUCLEOSHELL® PFP
USP L45	beta-cyclodextrin bonded to porous silica particles, R,S-hydroxypropyl ether derivative, 3 to 10 µm diameter	NUCLEODEX β-OH, β-PM
USP L58	strong cation-exchange resin consisting of sulfonated cross-linked PS/DVB copolymer in the Na form, 6 to 30 µm diameter	NUCLEOGEL® SUGAR Na
USP L60	spherical porous silica gel, particle size of 10 µm diameter or smaller, the surface of which has been covalently modified with alkyl amide groups and endcapped	NUCLEODUR® PolarTec
		NUCLEOSIL® C ₁₈ Nautilus
USP L75	A chiral-recognition protein, bovine serum albumin (BSA), chemically bonded to silica particles, about 7 µm in diameter, with a pore size of 300 Angstrom	RESOLVOSIL BSA-7

NUCLEOSIL® phase overview

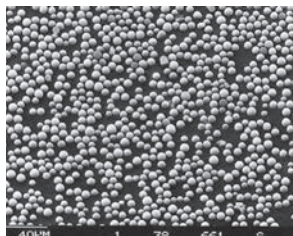

Feature

- Chromatography 분야의 범용 HPLC 컬럼
- HPLC에 사용되는 최초의 구형 실리카
- 균일한 Silica 구조로 광범위한 적용이 가능
- 다양한 고정상 제공
- 최적화된 결합 기술로 높은 분리 성능
- 높은 화학적 및 기계적 안정성
- Pore Size : 50, 100, 120, 300, 500, 1000 Å
- Particle Size : 3, 5, 7, 10 μm

Overview of NUCLEOSIL® HPLC phases

Phase	Specification	Stability	Interactions	Structure
NUCLEOSIL® RP-phases				
C ₁₈	octadecyl phase, medium density modification, endcapping 15 % C · USP L1	pH 2–8	hydrophobic (van der Waals) interactions slight residual silanol interactions	<p>NUCLEOSIL® (Si-O)₂_n</p>
C ₁₈ HD	octadecyl phase, high density monomeric modification, endcapping 20 % C · USP L1	pH 2–9	hydrophobic (van der Waals) interactions	<p>NUCLEOSIL® (Si-O)₂_n</p>
C ₁₈ AB	octadecyl phase, special crosslinked modification, endcapping 25 % C · USP L1	pH 1–9	steric and hydrophobic interactions	<p>NUCLEOSIL® (Si-O)₂_n</p>
C ₁₈ Nautilus	octadecyl phase, embedded polar group, endcapping 16 % C · USP L60	pH 2–8 up to 100 % H ₂ O	hydrophobic and polar interactions	<p>NUCLEOSIL® (Si-O)₂_n</p>
Protect I	special RP phase, protective polar group, monomeric modification, endcapping 11 % C	pH 2–8 up to 100 % H ₂ O	hydrophobic and polar interactions	<p>NUCLEOSIL® (Si-O)₂_n</p>

HPLC Column NUCLEOSIL® phase overview



Made in Germany

NUCLEOSIL®
HPLC Column

NUCLEOSIL® phase overview



Overview of NUCLEOSIL® HPLC phases

Phase	Specification	Stability	Interactions	Structure
NUCLEOSIL® RP-phases				
 C ₈ ec	octyl phase, medium density modification, endcapping 9 % C · USP L7	pH 2–8	hydrophobic (van der Waals) interactions slight residual silanol interactions	NUCLEOSIL® (Si-O ₂) _h 
 C ₈	octyl phase, no endcapping 8.5 % C · USP L7	pH 2–8	hydrophobic (van der Waals) interactions noticeable residual silanol interactions	NUCLEOSIL® (Si-O ₂) _h 
 C ₈ HD	octyl phase, high density modification, endcapping 13 % C · USP L7	pH 2–8	hydrophobic (van der Waals) interactions	NUCLEOSIL® (Si-O ₂) _h 
 C ₄	butyl phase, medium density modification, endcapping ~ 2 % C · USP L26	pH 2–8	hydrophobic (van der Waals) interactions residual silanol interactions	NUCLEOSIL® (Si-O ₂) _h 
 C ₂	dimethyl phase 3.5 % C · USP L16	pH 2–8	hydrophobic (van der Waals) interactions noticeable residual silanol interactions	NUCLEOSIL® (Si-O ₂) _h 
 C ₆ H ₅	phenyl phase, no endcapping 8 % C · USP L11	pH 2–8	π–π interactions and hydrophobic interactions noticeable residual silanol interactions	NUCLEOSIL® (Si-O ₂) _h 

HPLC Column NUCLEOSIL® phase overview





Made in Germany

NUCLEOSIL® phase overview

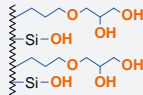

Overview of NUCLEOSIL® HPLC phases

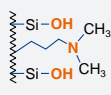
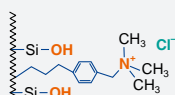
Phase	Specification	Stability	Interactions	Structure
Polar NUCLEOSIL® phases and NUCLEOSIL® ion exchangers				
 CN / CN-RP	cyano (nitrile) phase USP L10	pH 2–8	π - π , polar and hydrophobic interactions	NUCLEOSIL® (Si-O) ₂ _n 
 OH (Diol)	diol · USP L20	pH 2–8	polar interactions (hydrogen bonds)	NUCLEOSIL® (Si-O) ₂ _n 
 NH ₂ / NH ₂ -RP	amino · USP L8	pH 2–8	polar and hydrophobic interactions, weak ion exchange interactions	NUCLEOSIL® (Si-O) ₂ _n 
 N(CH ₃) ₂	dimethylamino	pH 2–8	polar and hydrophobic interactions, weak ion exchange interactions	NUCLEOSIL® (Si-O) ₂ _n 
 SA	sulfonic acid, strongly acid cation exchanger (SCX) USP L9	pH 2–8	strong ion exchange interactions	NUCLEOSIL® (Si-O) ₂ _n 
 SB	quaternary ammonium, strongly basic anion exchanger (SAX) USP L14	pH 2–8	strong ion exchange interactions	NUCLEOSIL® (Si-O) ₂ _n 
 SiOH	unmodified spherical silica USP L3	pH 2–8	polar	NUCLEOSIL® (Si-O) ₂ _n 

HPLC Column

NUCLEOSIL® Column



Made in Germany

NUCLEOSIL®
HPLC Column

NUCLEOSIL® Column



NUCLEOSIL® octadecyl phases (C₁₈)

NUCLEOSIL® standard octadecyl phases · USP L1

Eluent in column acetonitrile – water

	ID	Length → 100 mm	125 mm	150 mm	250 mm	EC guard columns
NUCLEOSIL® 50-5 C₁₈ ec particle size 5 µm, pore size 50 Å, endcapped, 14.5 % C						
Analytical EC columns						
	4.6 mm				720098.46	721473.30
NUCLEOSIL® 100-3 C₁₈ particle size 3 µm, pore size 100 Å, endcapped, 15 % C						
Analytical EC columns						
	4 mm		720150.40		720133.40	721022.30
	4.6 mm	720841.46	720150.46	720949.46	720133.46	721022.30
NUCLEOSIL® 100-5 C₁₈ particle size 5 µm, pore size 100 Å, endcapped, 15 % C						
Analytical EC columns						
	2 mm		720002.20		720014.20	721074.20
	3 mm		720002.30		720014.30	721074.30
	4 mm	720141.40	720002.40	720120.40	720014.40	721074.30
	4.6 mm	720141.46	720002.46	720120.46	720014.46	721074.30
NUCLEOSIL® 100-7 C₁₈ particle size 7 µm, pore size 100 Å, endcapped, 15 % C						
Analytical EC columns						
	4 mm				720018.40	
	4.6 mm		720951.46	720110.46	720018.46	
NUCLEOSIL® 100-10 C₁₈ particle size 10 µm, pore size 100 Å, endcapped, 15 % C						
Analytical EC columns						
	4 mm				720023.40	
	4.6 mm		720701.46	720140.46	720023.46	
NUCLEOSIL® 120-3 C₁₈ particle size 3 µm, pore size 120 Å, endcapped, 11 % C						
Analytical EC columns						
	4 mm	720149.40	720040.40		720055.40	721075.30
	4.6 mm	720149.46	720040.46	720740.46	720055.46	721075.30
NUCLEOSIL® 120-5 C₁₈ particle size 5 µm, pore size 120 Å, endcapped, 11 % C						
Analytical EC columns						
	4 mm		720051.40		720041.40	721070.30
	4.6 mm		720051.46	720730.46	720041.46	721070.30
NUCLEOSIL® 120-7 C₁₈ particle size 7 µm, pore size 120 Å, endcapped, 11 % C						
Analytical EC columns						
	4 mm				720042.40	
NUCLEOSIL® 120-10 C₁₈ particle size 10 µm, pore size 120 Å, endcapped, 11 % C						
Analytical EC columns						
	4 mm				720043.40	
	4.6 mm				720043.46	

NUCLEOSIL® Column







NUCLEOSIL® octadecyl phases (C₁₈)

NUCLEOSIL® C₁₈ HD · USP L1

NUCLEOSIL® C₁₈ AB · USP L1

NUCLEOSIL® C₁₈ Nautilus · USP L60

Eluent in column acetonitrile – water



	ID	Length → 100 mm	125 mm	150 mm	250 mm	EC guard columns
NUCLEOSIL® 100-3 C₁₈ HD particle size 3 µm, pore size 100 Å, 20 % C						
Analytical EC columns						
	4 mm		720191.40			721196.30
	4.6 mm		720191.46	720193.46		721196.30
NUCLEOSIL® 100-5 C₁₈ HD particle size 5 µm, pore size 100 Å, 20 % C						
Analytical EC columns						
	4 mm		720296.40		720280.40	721072.30
	4.6 mm		720296.46	720294.46	720280.46	721072.30
NUCLEOSIL® 100-5 C₁₈ AB particle size 5 µm, pore size 100 Å, 25 % C						
Analytical EC columns						
	4 mm		720935.40		720936.40	721073.30
	4.6 mm		720935.46	720305.46	720936.46	721073.30
NUCLEOSIL® 100-3 C₁₈ Nautilus particle size 3 µm, pore size 100 Å, 16 % C						
Analytical EC columns						
	4 mm		720472.40			721649.30
	4.6 mm		720472.46	720471.46		721649.30
NUCLEOSIL® 100-5 C₁₈ Nautilus particle size 5 µm, pore size 100 Å, 16 % C						
Analytical EC columns						
	4 mm		720430.40		720431.40	721133.30
	4.6 mm		720430.46	720432.46	720431.46	721133.30

NUCLEOSIL® Column



NUCLEOSIL® octadecyl phases (C₁₈) wide pore octadecyl phases · USP L1

Eluent in column acetonitrile – water

	ID	Length → 250 mm	EC guard columns
NUCLEOSIL® 300-5 C₁₈ particle size 5 µm, pore size 300 Å, endcapped, 6.5 % C			
Analytical EC columns			
	4 mm	720065.40	721085.30
	4.6 mm	720065.46	721085.30
NUCLEOSIL® 500-7 C₁₈ particle size 7 µm, pore size 500 Å, endcapped, 2 % C			
Analytical EC columns			
	4.6 mm	720074.46	
NUCLEOSIL® 1000-7 C₁₈ particle size 7 µm, pore size 1000 Å, endcapped, ~ 1 % C			
Analytical EC columns			
	4.6 mm	720077.46	

EC columns in packs of 1, guard columns in packs of 3.

NUCLEOSIL® 100 Protect I special RP phase with protective polar group

Eluent in column acetonitrile – water

	ID	Length → 125 mm	150 mm	250 mm	EC guard columns
NUCLEOSIL® 100-5 Protect I particle size 5 µm, pore size 100 Å					
Analytical EC columns					
	4 mm	720175.40		720170.40	721157.30
	4.6 mm	720175.46	720174.46	720170.46	721157.30

HPLC Column

NUCLEOSIL® Column



Made in Germany

NUCLEOSIL® Column



NUCLEOSIL® octyl phases (C₈) NUCLEOSIL® standard octyl phases · USP L7

Eluent in column acetonitrile – water

	ID	Length → 125 mm	150 mm	250 mm	EC guard columns
NUCLEOSIL® 100-5 C₈ ec particle size 5 µm, pore size 100 Å, endcapped, 9 % C					
Analytical EC columns					
	4.6 mm			720165.46	721096.30
NUCLEOSIL® 100-5 C₈ particle size 5 µm, pore size 100 Å, not endcapped, 8.5 % C					
Analytical EC columns					
	4 mm	720001.40		720013.40	721194.30
	4.6 mm	720001.46	720990.46	720013.46	721194.30
NUCLEOSIL® 100-7 C₈ particle size 7 µm, pore size 100 Å, not endcapped, 8.5 % C					
Analytical EC columns					
	4.6 mm			720017.46	
NUCLEOSIL® 100-10 C₈ particle size 10 µm, pore size 100 Å, not endcapped, 8.5 % C					
Analytical EC columns					
	4 mm			720022.40	
	4.6 mm			720022.46	
NUCLEOSIL® 120-3 C₈ particle size 3 µm, pore size 120 Å, not endcapped, 6.5 % C					
Analytical EC columns					
	4 mm	720071.40			721093.30
	4.6 mm	720071.46	720214.46		721093.30
NUCLEOSIL® 120-5 C₈ particle size 5 µm, pore size 120 Å, not endcapped, 6.5 % C					
Analytical EC columns					
	4 mm	720050.40		720052.40	721095.30
	4.6 mm	720050.46	720735.46	720052.46	721095.30
NUCLEOSIL® 300-5 C₈ particle size 5 µm, pore size 300 Å, not endcapped, ~ 3 % C					
Analytical EC columns					
	4.6 mm			720062.46	721061.30

EC columns in packs of 1, guard columns in packs of 3.

Custom-packed columns with different column dimensions are available on request.

NUCLEOSIL® Column



NUCLEOSIL® octyl phases (C₈) NUCLEOSIL® C₈ HD · USP L7

Eluent in column acetonitrile – water

	ID	Length → 125 mm	150 mm	250 mm	EC guard columns
NUCLEOSIL® 100-5 C₈ HD particle size 5 µm, pore size 100 Å					
Analytical EC columns					
	4 mm			720196.40	721071.30
	4.6 mm		720194.46	720196.46	721071.30

EC columns in packs of 1, guard columns in packs of 3.

Custom-packed columns with different column dimensions are available on request.

NUCLEOSIL® butyl phases (C₄) · USP L26

Eluent in column acetonitrile – water

	ID	Length → 250 mm	EC guard columns
NUCLEOSIL® 120-5 C₄ particle size 5 µm, pore size 120 Å			
Analytical EC columns			
	4.6 mm	720096.46	721083.30
NUCLEOSIL® 300-5 C₄ particle size 5 µm, pore size 300 Å			
Analytical EC columns			
	4 mm	720059.40	721916.30
	4.6 mm	720059.46	721916.30

EC columns in packs of 1, guard columns in packs of 3.

NUCLEOSIL® dimethyl phase (C₂) · USP L16

Eluent in column acetonitrile – water



	ID	Length → 250 mm	EC guard columns
NUCLEOSIL® 100-7 C₂ particle size 7 µm, pore size 100 Å			
Analytical EC columns			
	4.6 mm	720089.46	721030.30

NUCLEOSIL® Column



NUCLEOSIL® phenyl phases (C₆H₅) · USP L11

Eluent in column acetonitrile – water

	ID	Length → 250 mm	EC guard columns
NUCLEOSIL® 100-5 C₆H₅ particle size 5 µm, pore size 100 Å, not endcapped			
Analytical EC columns			
	4.6 mm	720956.46	721137.30
NUCLEOSIL® 100-7 C₆H₅ particle size 7 µm, pore size 100 Å, not endcapped			
Analytical EC columns			
	4 mm	720019.40	
	4.6 mm	720019.46	



NUCLEOSIL® diol phases · USP L20

Eluent in column is n-heptane. When using an eluent which is not miscible with n-heptane (e.g., water), it is necessary to rinse the column with THF first.

	ID	Length → 250 mm	EC guard columns
NUCLEOSIL® 100-5 OH (Diol) particle size 5 µm, pore size 100 Å			
Analytical EC columns			
	4.6 mm	720143.46	721142.30

NUCLEOSIL® amino phases · USP L8

Eluent in column is n-heptane (except for NH₂ RP). When using an eluent which is not miscible with n-heptane (e.g., water), it is necessary to rinse the column with THF first.

	ID	Length → 250 mm	EC guard columns
NUCLEOSIL® 100-5 NH₂ particle size 5 µm, pore size 100 Å; eluent in column n-heptane			
Analytical EC columns			
	4.6 mm	720095.46	721020.30
NUCLEOSIL® 100-5 NH₂-RP particle size 5 µm, pore size 100 Å; eluent in column acetonitrile – water (80:20)			
Analytical EC columns			
	4.6 mm	720095.46RP	721155.30
NUCLEOSIL® 100-10 NH₂ particle size 10 µm, pore size 100 Å; eluent in column n-heptane			
Analytical EC columns			
	4.6 mm	720025.46	

NUCLEOSIL® Column







NUCLEOSIL® dimethylamino phase

Eluent in column is n-heptane. When using an eluent which is not miscible with n-heptane (e.g., water), it is necessary to rinse the column with THF first.

	ID	Length → 250 mm	EC guard columns
NUCLEOSIL® 100-5 N(CH₃)₂ particle size 5 µm, pore size 100 Å			
Analytical EC columns			
	4.6 mm	720994.46	721158.30

NUCLEOSIL® cyano phases · USP L10

Eluent in column (except for NUCLEOSIL® 100-5 CN-RP) is n-heptane. When using an eluent which is not miscible with n-heptane (e.g., water), it is necessary to rinse the column with THF first.

	ID	Length → 250 mm	EC guard columns
NUCLEOSIL® 100-5 CN particle size 5 µm, pore size 100 Å; eluent in column n-heptane			
Analytical EC columns			
	4 mm	720090.40	721078.30
	4.6 mm	720090.46	721078.30
NUCLEOSIL® 100-5 CN-RP particle size 5 µm, pore size 100 Å; eluent in column acetonitrile – water			
Analytical EC columns			
	4 mm	720205.40	721039.30
	4.6 mm	720205.46	721039.30
NUCLEOSIL® 100-10 CN particle size 10 µm, pore size 100 Å; eluent in column n-heptane			
Analytical EC columns			
	4 mm	720024.40	
	4.6 mm	720024.46	
NUCLEOSIL® 120-7 CN particle size 7 µm, pore size 120 Å; eluent in column n-heptane			
Analytical EC columns			
	4 mm	720057.40	
	4.6 mm	720057.46	

HPLC Column

NUCLEOSIL® Column





Made in Germany

NUCLEOSIL® Column





NUCLEOSIL® SA phases · USP L9

Eluent in column 0.15 mol/L (NH₄)₂HPO₄, pH 5

	ID	Length → 125 mm	150 mm	250 mm	EC guard columns
NUCLEOSIL® 100-5 SA particle size 5 µm, pore size 100 Å					
Analytical EC columns					
	4 mm			720097.40	721024.30
	4.6 mm	720709.46	720182.46	720097.46	721024.30
NUCLEOSIL® 100-10 SA particle size 10 µm, pore size 100 Å					
Analytical EC columns					
	4.6 mm			720028.46	



NUCLEOSIL® SB phases · USP L14

Eluent in column 0.15 mol/L (NH₄)₂HPO₄, pH 5

	ID	Length → 125 mm	150 mm	250 mm	EC guard columns
NUCLEOSIL® 100-5 SB particle size 5 µm, pore size 100 Å					
Analytical EC columns					
	4 mm			720996.40	721025.30
	4.6 mm	720989.46	720183.46	720996.46	721025.30
NUCLEOSIL® 100-10 SB particle size 10 µm, pore size 100 Å					
Analytical EC columns					
	4.6 mm			720029.46	

NUCLEOSIL® SiOH unmodified silica · USP L3

Eluent in column is n-heptane. When using an eluent which is not miscible with n-heptane (e.g., water), it is necessary to rinse the column with THF first.

	ID	Length → 250 mm	EC guard columns
NUCLEOSIL® 50-5 particle size 5 µm, pore size 50 Å			
Analytical EC columns			
	4.6 mm	720093.46	721167.30
NUCLEOSIL® 100-5 particle size 5 µm, pore size 100 Å			
Analytical EC columns			
	4.6 mm	720099.46	720099.46 721518.30

HPLC Column

LiChrospher® Column



Made in Germany

NUCLEOSIL®
HPLC Column

Analytical columns with LiChrospher®



LiChrospher® packings manufactured by E. Merck (D)

Phase	USP	Particle size	Pore size	Modification	Endcapped	Carbon content
LiChrospher® 100 RP 18, 5 µm	L1	nom. 5 µm	100 Å	Octadecyl	–	21 %
LiChrospher® 100 RP 18 ec, 5 µm	L1	nom. 5 µm	100 Å	Octadecyl	+	21 %
LiChrospher® 60 RP select B, 5 µm	L7	nom. 5 µm	60 Å	Octyl	+	12 %

All phases as packed ChromCart® cartridges

ChromCart® columns require the CC connecting kit (REF 721690).

Eluent in column acetonitrile – water

ID	Length → 125 mm	150 mm	250 mm	EC guard columns
LiChrospher® 100 RP 18, 5 µm particle size 5 µm, pore size 100 Å				
2 mm	728031.20		728032.20	728053.30
3 mm	728031.30		728032.30	728053.30
4 mm	728031.40		728032.40	728053.40
4.6 mm	728031.46	728033.46	728032.46	728053.40
LiChrospher® 100 RP 18 ec, 5 µm particle size 5 µm, pore size 100 Å				
2 mm	728034.20		728035.20	728054.30
3 mm	728034.30		728035.30	728054.30
4 mm	728034.40		728035.40	728054.40
4.6 mm	728034.46	728036.46	728035.46	728054.40
LiChrospher® 60 RP select B, 5 µm particle size 5 µm, pore size 100 Å				
2 mm	728037.20		728038.20	728055.30
3 mm	728037.30		728038.30	728055.30
4 mm	728037.40		728038.40	728055.40
4.6 mm	728037.46	728039.46	728038.46	728055.40

* can directly be used with the CC connecting kit (REF 721690).

8 mm ChromCart® guard column cartridges in packs of 3, all other columns in packs of 1.

HPLC Column NUCLEODUR® phase overview



Made in Germany

NUCLEODUR® phase overview



Feature

- 고순도 실리카를 사용한 HPLC/UHPLC 컬럼
- 최첨단 3세대 실리카 (B Type)
- 완전 구형 및 매끄럽고 부드러운 표면의 실리카
: Peak tailing 최소화
- 높은 압력 및 유량에 대한 안정성 우수
- Metal 불순물 함유 극소화
- Particle Size : 1.8, 3, 5, 7, 10, 12, 16, 20, 30, 50 μm

Overview of NUCLEODUR® HPLC phases

Phase	Specification	Characteristic*	Stability	Structure
C ₁₈ Gravity	octadecyl, high density coating, multi-endcapping 18 % C · USP L1	A ●●●●●	pH 1–11, suitable for LC/MS	NUCLEODUR® (Si-O) _n
		B ●		
		C ●●●		
C ₁₈ Gravity-SB	octadecyl (monomeric), extensive endcapping 13 % C · USP L1	A ●●●●●	pH 1–9, suitable for LC/MS	NUCLEODUR® (Si-O) _n
		B ●●●		
		C -		
C ₈ Gravity	octyl, high density coating, multi-endcapping 11 % C · USP L7	A ●●●●	pH 1–11, suitable for LC/MS	NUCLEODUR® (Si-O) _n
		B ●		
		C ●●		
C ₁₈ Isis	octadecyl phase with specially crosslinked surface modification endcapping 20 % C · USP L1	A ●●●●●	pH 1–10, suitable for LC/MS	NUCLEODUR® (Si-O) _n
		B ●●		
		C ●●●●●		
C ₁₈ Pyramid	octadecyl with polar endcapping 14 % C · USP L1	A ●●●●●	stable in 100 % aqueous eluent, pH 1–9, suitable for LC/MS	NUCLEODUR® (Si-O) _n
		B ●●●		
		C ●●		

* A = ● hydrophobic selectivity, B = ● polar / ionic selectivity, C = ● steric selectivity

NUCLEODUR® phase overview



Advantage of 1.8 µm particle size

- 분리 시간 단축 (Ultra fast HPLC)
- 분리 효율이 높고 짧은 컬럼 길이
- 해상도 및 감지 감도 향상
- 높은 구형도와 좁은 입자 크기 분포로 Back pressure를 적당한 수준으로 유지
- Low bleeding으로 LC/MS에 적합

Availability (1.8 µm particle size) :

C₁₈ Gravity, C₈ Gravity, C₁₈ Gravity-SB, C₁₈ Isis, C₁₈ Pyramid, PolarTec, Phenyl-Hexyl, PFP, Sphinx RP, C₁₈ HTec and HILIC

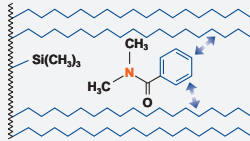
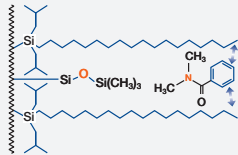
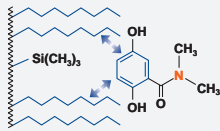
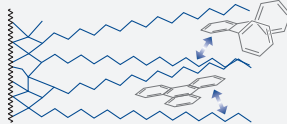
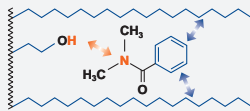
Application	Similar phases**	Interactions · retention mechanism
in general compounds with ionizable functional groups such as basic pharmaceuticals and pesticides	NUCLEOSIL® C ₁₈ HD Xterra® RP18 / MS C18; Luna® C18(2), Gemini®, Synergi® Max RP; Zorbax® Extend-C18; Inertsil® ODS III; Purospher® STAR RP-18; Hypersil™ BDS	hydrophobic (van der Waals interactions) 
overall sophisticated analytical separations, especially for polar compounds, e.g., antibiotics, water-soluble vitamins, organic acids	-	hydrophobic (van der Waals interactions) with additional polar interactions 
like C ₁₈ Gravity, however, generally shorter retention times for nonpolar compounds	NUCLEOSIL® C ₈ HD Xterra® RP8 / MS C8; Luna® C8; Zorbax® Eclipse XDB-C8	hydrophobic (van der Waals interactions) 
high steric selectivity, thus suited for separation of positional and structural isomers, planar / nonplanar molecules	NUCLEOSIL® C ₁₈ AB Inertsil® ODS-P; Pro C18 RS	steric and hydrophobic 
basic pharmaceuticals, very polar compounds, organic acids	Aqua, Synergi® Hydro-RP; AQ; Atlantis® dC18; Polaris® C18-A	hydrophobic and polar (H bonds) 

** phases which provide a similar selectivity based on chemical and physical properties

HPLC Column NUCLEODUR® phase overview



Made in Germany

NUCLEODUR® phase overview



Overview of NUCLEODUR® HPLC phases

Phase	Specification	Characteristic*	Stability	Structure
PolarTec	octadecyl with embedded polar group 17 % C · USP L1 and L60	A	stable in 100 % aqueous eluent, pH 1–9, suitable for LC/MS	NUCLEODUR® (Si-O) _n
		B		
		C		
PolarTec	phenylhexyl, multi-endcapping 10 % C · USP L11	A	pH 1–10, suitable for LC/MS	NUCLEODUR® (Si-O) _n
		B		
		C		
π ²	biphenylpropyl, multi-endcapping 17 % C · USP L11	A	pH 1.5–10	NUCLEODUR® (Si-O) _n
		B		
		C		
PFP	pentafluorophenylpropyl, multi-endcapping 8 % C · USP L43	A	pH 1–9, suitable for LC/MS	NUCLEODUR® (Si-O) _n
		B		
		C		
Sphinx RP	bifunctional, balanced ratio of propylphenyl and octadecyl, endcapping 15 % C · USP L1 and L11	A	pH 1–10, suitable for LC/MS	NUCLEODUR® (Si-O) _n
		B		
		C		
C ₁₈ HTec	octadecyl, high density coating, high capacity, multi-endcapping 18 % C · USP L1	A	pH 1–11, suitable for LC/MS	NUCLEODUR® (Si-O) _n
		B		
		C		
C ₁₈ ec	octadecyl, medium density, endcapping available in 110 Å and 300 Å pore size 17.5 % / 4 % C · USP L1	A	pH 1–9	NUCLEODUR® (Si-O) _n
		B		
		C		

* A = hydrophobic selectivity, B = polar / ionic selectivity, C = steric selectivity

HPLC Column NUCLEODUR® phase overview



Made in Germany

NUCLEODUR®
HPLC Column

NUCLEODUR® phase overview



	Application	Similar phases**	Interactions · retention mechanism
	basic pharmaceuticals, organic acids, pesticides, amino acids, water-soluble vitamins	NUCLEOSIL® C ₁₈ Nautilus ProntoSIL® C18 AQ, Zorbax® Bonus-RP, Polaris® Amide-C18; Ascentis® RP Amide, SymmetryShield™ RP18; SUPELCOSIL™ LC-ABZ+; HyPURITY™ ADVANCE; ACCLAIM Polar AD.II	hydrophobic and polar (H bonds)
	aromatic and unsaturated compounds, polar compounds like pharmaceuticals, antibiotics	Luna® Phenyl-Hexyl; Zorbax® Eclipse Plus Phenyl-Hexyl; Kromasil® Phenyl-Hexyl	π - π and hydrophobic
	aromatic and unsaturated compounds, polar compounds like pharmaceuticals, antibiotics	Pinnacle® DB Biphenyl; Ultra Biphenyl	π - π and hydrophobic
	aromatic and unsaturated compounds, halogen compounds, phenols, isomers, polar pharmaceuticals, antibiotics	ACQUITY® CSH Fluoro-Phenyl; Hypersil™ GOLD PFP; Luna® PFP(2); Discovery® HS F5; Allure® PFP Propyl; Ultra II PFP Propyl	polar (H bond), dipole-dipole, π - π and hydrophobic
	compounds with aromatic and multiple bond systems	no similar phases	π - π and hydrophobic
	robust and well base deactivated C ₁₈ phase; all separation tasks with preparative potential	Xterra® RP18 / MS C18 / SunFire™ C18; Luna® C18(2), Gemini®, Synergi® Max RP; Zorbax® Extend-C18; Inertsil® ODS III; Purospher® STAR RP-18; Hypersil® BDS	hydrophobic (van der Waals interactions)
	robust C ₁₈ phase for routine analyses	NUCLEOSIL® C ₁₈ Spherisorb® ODS II; Symmetry® C18; Hypersil® ODS; Inertsil® ODS II; Kromasil® C18; LiChrospher® RP-18	hydrophobic (van der Waals interactions) some residual silanol interactions

** phases which provide a similar selectivity based on chemical and physical properties

HPLC Column NUCLEODUR® phase overview



Made in Germany

NUCLEODUR® phase overview



Overview of NUCLEODUR® HPLC phases

Phase	Specification	Characteristic*	Stability	Structure
C ₈ ec	octyl, medium density, endcapping 10.5 % C · USP L7	A ●●	pH 1–9	NUCLEODUR® (Si-O) _n
		B ●●		
		C ●●●		
C ₄ ec	butyl, medium density, endcapping, 300 Å pore size 2.5 % C · USP L26	A ●	pH 1–9	NUCLEODUR® (Si-O) _n
		B ●●		
		C ●●		
HILIC	zwitterionic ammonium – sulfonic acid phase 7 % C	A ●	pH 2–8.5	NUCLEODUR® (Si-O) _n
		B ●●●●		
		C -		
CN / CN-RP	cyano (nitrile) for NP and RP separations 7 % C · USP L10	A ●	pH 1–8, stable towards highly aqueous mobile phases	NUCLEODUR® (Si-O) _n
		B ●●●●		
		C -		
NH ₂ / NH ₂ -RP	aminopropyl for NP and RP separations 2.5 % C · USP L8	A ●	pH 2–8, stable towards highly aqueous mobile phases	NUCLEODUR® (Si-O) _n
		B ●●●●		
		C -		
SiOH	unmodified high purity silica · USP L3	A -	pH 2–8	NUCLEODUR® (Si-O) _n
		B -		
		C -		

* A = ● hydrophobic selectivity, B = ● polar / ionic selectivity, C = ● steric selectivity

HPLC Column NUCLEODUR® phase overview



Made in Germany

NUCLEODUR®
HPLC Column

NUCLEODUR® phase overview

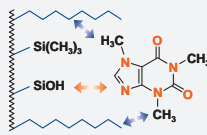
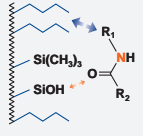
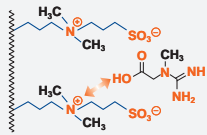
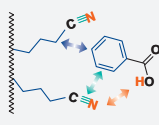
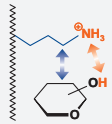

Application	Similar phases**	Interactions · retention mechanism
robust C ₈ phase for routine analyses	NUCLEOSIL® C ₈ ec / C ₈ Spherisorb® C8; Symmetry® C8; Hypersil® MOS; Kromasil® C8; LiChrospher® RP-8	hydrophobic (van der Waals interactions) some residual silanol interactions 
biological macromolecules like proteins or peptides	Jupiter® C4; ACE® C4	hydrophobic (van der Waals interactions) some residual silanol interactions 
hydrophilic compounds such as polar organic acids and bases, polar natural compounds	Sequant™ ZIC®-HILIC; Obelisc™	ionic / hydrophilic and electrostatic 
polar organic compounds (basic drugs), molecules containing π-electron systems	NUCLEOSIL® CN / CN-RP	π-π and polar (H bond), hydrophobic 
sugars, sugar alcohols and other hydroxy compounds, DNA bases, polar compounds in general	NUCLEOSIL® NH ₂ / NH ₂ -RP	polar / ionic and hydrophobic 
polar compounds in general	NUCLEOSIL® SiOH	polar / ionic 

** phases which provide a similar selectivity based on chemical and physical properties

HPLC Column NUCLEODUR® Column







Made in Germany

NUCLEODUR® Column



NUCLEODUR® C₁₈ Gravity · C₈ Gravity nonpolar high density phase · USP L1 (C₁₈) · USP L7 (C₈)

Eluent in column acetonitrile – water

	ID	Length → 30 mm	50 mm	75 mm	100 mm	125 mm	150 mm	250 mm
NUCLEODUR® C₁₈ Gravity, 1.8 µm octadecyl phase, particle size 1.8 µm, 18 % C · UHPLC								
Analytical EC columns								
	2 mm	760078.20	760079.20	760071.20	760076.20		760075.20	
	3 mm	760078.30	760079.30		760076.30			
	4 mm	760078.40	760079.40		760076.40			
	4.6 mm	760078.46	760079.46		760076.46			
EC guard columns*			4 x 2 mm: 761901.20		4 x 3 mm: 761901.30			
NUCLEODUR® C₁₈ Gravity, 3 µm octadecyl phase, particle size 3 µm, 18 % C								
Analytical EC columns								
	2 mm		760080.20		760084.20	760081.20	760083.20	760082.20
	3 mm		760080.30		760084.30	760081.30	760083.30	760082.30
	4 mm		760080.40		760084.40	760081.40	760083.40	760082.40
	4.6 mm		760080.46	760086.46	760084.46	760081.46	760083.46	760082.46
EC guard columns*			4 x 2 mm: 761902.20		4 x 3 mm: 761902.30			
NUCLEODUR® C₁₈ Gravity, 5 µm octadecyl phase, particle size 5 µm, 18 % C								
Analytical EC columns								
	2 mm		760102.20		760104.20	760100.20	760103.20	760101.20
	3 mm		760102.30		760104.30	760100.30	760103.30	760101.30
	4 mm		760102.40		760104.40	760100.40	760103.40	760101.40
	4.6 mm		760102.46	760106.46	760104.46	760100.46	760103.46	760101.46
EC guard columns*			4 x 2 mm: 761903.20		4 x 3 mm: 761903.30			
Preparative VarioPrep columns								
	10 mm		762103.100			762109.100		762113.100
	21 mm		762103.210			762109.210		762113.210
	32 mm							762113.320
	40 mm						762100.400	762113.400
VP guard columns***			10 x 8 mm: 762160.80		10 x 16 mm: 762160.160		15 x 32 mm: 762163.320	
NUCLEODUR® C₁₈ Gravity, 10 µm octadecyl phase, particle size 10 µm, 18 % C								
Preparative VarioPrep columns								
	21 mm							762250.210
	40 mm							762250.400
VP guard columns **					10 x 16 mm: 762160.160		15 x 32 mm: 762163.320	

HPLC Column

NUCLEODUR® Column



Made in Germany

NUCLEODUR®
HPLC Column

NUCLEODUR® Column



Eluent in column acetonitrile – water

ID	Length → 30 mm	50 mm	75 mm	100 mm	125 mm	150 mm	250 mm	
NUCLEODUR® C₈ Gravity, 1.8 μm octyl phase, particle size 1.8 μm, 11 % C · UHPLC								
Analytical EC columns								
	2 mm	760756.20	760755.20	760760.20	760757.20		760759.20	
	3 mm	760756.30	760755.30		760757.30			
	4 mm	760756.40	760755.40		760757.40			
	4.6 mm	760756.46	760755.46		760757.46			
EC guard columns*		4 x 2 mm: 761905.20		4 x 3 mm: 761905.30				
NUCLEODUR® C₈ Gravity, 5 μm octyl phase, particle size 5 μm, 11 % C								
Analytical EC columns								
	2 mm		760750.20		760754.20	760751.20	760752.20	760753.20
	3 mm		760750.30		760754.30	760751.30	760752.30	760753.30
	4 mm		760750.40		760754.40	760751.40	760752.40	760753.40
	4.6 mm		760750.46	760749.46	760754.46	760751.46	760752.46	760753.46
EC guard columns*		4 x 2 mm: 761907.20		4 x 3 mm: 761907.30				
Preparative VarioPrep columns								
	10 mm		762081.100			762071.100		762070.100
	21 mm		762081.210			762071.210	762082.210	762070.210
VP guard columns **		10 x 8 mm: 762097.80		10 x 16 mm: 762097.160				

EC and VarioPrep columns in packs of 1

NUCLEODUR® C₁₈ Gravity-SB hydrophobic phase with polar selectivity · USP L1

ID	Length → 30 mm	50 mm	75 mm	100 mm	125 mm	150 mm	250 mm	
NUCLEODUR® C₁₈ Gravity-SB, 1.8 μm particle size 1.8 μm · UHPLC								
Analytical EC columns								
	2 mm	760591.20	760593.20	760595.20	760596.20		760598.20	
	3 mm	760591.30	760593.30		760596.30			
	4 mm	760591.40	760593.40		760596.40			
	4.6 mm	760591.46	760593.46		760596.46			
EC guard columns*		4 x 2 mm: 761990.20		4 x 3 mm: 761990.30				
NUCLEODUR® C₁₈ Gravity-SB, 3 μm particle size 3 μm								
Analytical EC columns								
	2 mm		760603.20		760606.20	760607.20	760608.20	760609.20
	3 mm		760603.30		760606.30	760607.30	760608.30	760609.30
	4 mm		760603.40		760606.40	760607.40	760608.40	760609.40
	4.6 mm		760603.46	760605.46	760606.46	760607.46	760608.46	760609.46
EC guard columns*		4 x 2 mm: 761991.20		4 x 3 mm: 761991.30				
NUCLEODUR® C₁₈ Gravity-SB, 5 μm particle size 5 μm								
Analytical EC columns								
	2 mm		760613.20		760616.20	760617.20	760618.20	760619.20
	3 mm		760613.30		760616.30	760617.30	760618.30	760619.30
	4 mm		760613.40		760616.40	760617.40	760618.40	760619.40
	4.6 mm		760613.46	760615.46	760616.46	760617.46	760618.46	760619.46
EC guard columns*		4 x 2 mm: 761992.20		4 x 3 mm: 761992.30				
Preparative VarioPrep columns								
	10 mm		762350.100			762351.100		762353.100
	21 mm		762350.210			762351.210		762353.210
	32 mm							762353.320
	40 mm						762352.400	762353.400
VP guard columns **		10 x 8 mm: 762354.80		10 x 16 mm: 762354.160		15 x 32 mm: 762355.320		

EC and VarioPrep columns in packs of 1

HPLC Column NUCLEODUR® Column







Made in Germany

NUCLEODUR® Column



NUCLEODUR® C₁₈ Isis phase with high steric selectivity · USP L1

Eluent in column acetonitrile – water

	ID	Length → 30 mm	50 mm	75 mm	100 mm	125 mm	150 mm	250 mm
NUCLEODUR® C₁₈ Isis, 1.8 µm particle size 1.8 µm · UHPLC								
Analytical EC columns								
	2 mm	760406.20	760405.20	760396.20	760407.20		760409.20	
	3 mm	760406.30	760405.30		760407.30			
	4 mm	760406.40	760405.40		760407.40			
	4.6 mm	760406.46	760405.46		760407.46			
EC guard columns*			4 x 2 mm: 761910.20		4 x 3 mm: 761910.30			
NUCLEODUR® C₁₈ Isis, 3 µm particle size 3 µm								
Analytical EC columns								
	2 mm		760400.20		760401.20	760402.20	760403.20	760404.20
	3 mm		760400.30		760401.30	760402.30	760403.30	760404.30
	4 mm		760400.40		760401.40	760402.40	760403.40	760404.40
	4.6 mm		760400.46	760397.46	760401.46	760402.46	760403.46	760404.46
EC guard columns*			4 x 2 mm: 761911.20		4 x 3 mm: 761911.30			
NUCLEODUR® C₁₈ Isis, 5 µm particle size 5 µm								
Analytical EC columns								
	2 mm		760410.20		760415.20	760412.20	760413.20	760414.20
	3 mm		760410.30		760415.30	760412.30	760413.30	760414.30
	4 mm		760410.40		760415.40	760412.40	760413.40	760414.40
	4.6 mm		760410.46	760416.46	760415.46	760412.46	760413.46	760414.46
EC guard columns*			4 x 2 mm: 761912.20		4 x 3 mm: 761912.30			
Preparative VarioPrep columns								
	10 mm		762404.100			762405.100		762403.100
	21 mm		762404.210			762405.210		762403.210
	32 mm							762403.320
	40 mm						762406.400	762403.400
VP guard columns***			10 x 8 mm: 762420.80		10 x 16 mm: 762420.160		15 x 32 mm: 762422.320	

EC and VarioPrep columns in packs of 1

HPLC Column NUCLEODUR® Column



Made in Germany





NUCLEODUR®
HPLC Column

NUCLEODUR® Column



NUCLEODUR® C₁₈ Pyramid phase for highly aqueous eluents · USP L1

Eluent in column acetonitrile – water

	ID	Length → 30 mm	50 mm	75 mm	100 mm	125 mm	150 mm	250 mm
NUCLEODUR® C₁₈ Pyramid, 1.8 µm particle size 1.8 µm · UHPLC								
Analytical EC columns								
	2 mm	760271.20	760272.20	760275.20	760273.20		760274.20	
	3 mm	760271.30	760272.30		760273.30			
	4 mm	760271.40	760272.40		760273.40			
	4.6 mm	760271.46	760272.46		760273.46			
EC guard columns*			4 x 2 mm: 761910.20		4 x 3 mm: 761910.30			
NUCLEODUR® C₁₈ Pyramid, 3 µm particle size 3 µm								
Analytical EC columns								
	2 mm		760263.20		760264.20	760260.20	760261.20	760262.20
	3 mm		760263.30		760264.30	760260.30	760261.30	760262.30
	4 mm		760263.40		760264.40	760260.40	760261.40	760262.40
	4.6 mm		760263.46	760259.46	760264.46	760260.46	760261.46	760262.46
EC guard columns*			4 x 2 mm: 761911.20		4 x 3 mm: 761911.30			
NUCLEODUR® C₁₈ Pyramid, 5 µm particle size 5 µm								
Analytical EC columns								
	2 mm		760200.20		760204.20	760201.20	760203.20	760202.20
	3 mm		760200.30		760204.30	760201.30	760203.30	760202.30
	4 mm		760200.40		760204.40	760201.40	760203.40	760202.40
	4.6 mm		760200.46	760205.46	760204.46	760201.46	760203.46	760202.46
EC guard columns*			4 x 2 mm: 761912.20		4 x 3 mm: 761912.30			
Preparative VarioPrep columns								
	10 mm		762271.100			762273.100		762272.100
	21 mm		762271.210			762273.210		762272.210
	32 mm							762272.320
	40 mm						762269.400	762272.400
VP guard columns***			10 x 8 mm: 762420.80		10 x 16 mm: 762420.160		15 x 32 mm: 762422.320	

EC and VarioPrep columns in packs of 1

HPLC Column

NUCLEODUR® Column



Made in Germany

NUCLEODUR®
HPLC Column

NUCLEODUR® Column



NUCLEODUR® Phenyl-Hexyl productive for polar / aromatic compounds · USP L11

Eluent in column acetonitrile – water

	ID	Length → 30 mm	50 mm	75 mm	100 mm	125 mm	150 mm	250 mm
NUCLEODUR® Phenyl-Hexyl, 1.8 µm particle size 1.8 µm · UHPLC								
Analytical EC columns								
	2 mm	760561.20	760563.20	760565.20	760566.20		760568.20	
	3 mm	760561.30	760563.30		760566.30			
	4 mm	760561.40	760563.40		760566.40			
	4.6 mm	760561.46	760563.46		760566.46			
EC guard columns*			4 x 2 mm: 761985.20		4 x 3 mm: 761985.30			
NUCLEODUR® Phenyl-Hexyl, 3 µm particle size 3 µm								
Analytical EC columns								
	2 mm		760573.20		760576.20	760577.20	760578.20	760579.20
	3 mm		760573.30		760576.30	760577.30	760578.30	760579.30
	4 mm		760573.40		760576.40	760577.40	760578.40	760579.40
	4.6 mm		760573.46	760575.46	760576.46	760577.46	760578.46	760579.46
EC guard columns*			4 x 2 mm: 761986.20		4 x 3 mm: 761986.30			
NUCLEODUR® Phenyl-Hexyl, 5 µm particle size 5 µm								
Analytical EC columns								
	2 mm		760583.20		760586.20	760587.20	760588.20	760589.20
	3 mm		760583.30		760586.30	760587.30	760588.30	760589.30
	4 mm		760583.40		760586.40	760587.40	760588.40	760589.40
	4.6 mm		760583.46	760585.46	760586.46	760587.46	760588.46	760589.46
EC guard columns*			4 x 2 mm: 761987.20		4 x 3 mm: 761987.30			
Preparative VarioPrep columns								
	10 mm		762210.100			762211.100		762213.100
	21 mm		762210.210			762211.210		762213.210
	32 mm							762213.320
	40 mm						762212.400	762213.400
VP guard columns***			10 x 8 mm: 762234.80		10 x 16 mm: 762234.160		15 x 32 mm: 762236.320	

EC and VarioPrep columns in packs of 1

NUCLEODUR® π² hydrophobic biphenylpropyl phase · USP L11

Eluent in column acetonitrile – water

	ID	Length → 50 mm	75 mm	100 mm	125 mm	150 mm	250 mm
NUCLEODUR® π², 5 µm particle size 5 µm							
Analytical EC columns							
	2 mm	760620.20	760621.20	760622.20	760623.20	760624.20	760625.20
	3 mm	760620.30	760621.30	760622.30	760623.30	760624.30	760625.30
	4 mm	760620.40	760621.40	760622.40	760623.40	760624.40	760625.40
	4.6 mm	760620.46	760621.46	760622.46	760623.46	760624.46	760625.46
EC guard columns*		4 x 2 mm: 761810.20			4 x 3 mm: 761810.30		

EC and VarioPrep columns in packs of 1

HPLC Column NUCLEODUR® Column





Made in Germany

NUCLEODUR® Column



NUCLEODUR® PFP hydrophobic pentafluorophenyl phase · USP L43

Eluent in column acetonitrile – water

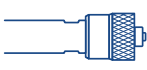
	ID	Length → 30 mm	50 mm	75 mm	100 mm	125 mm	150 mm	250 mm
NUCLEODUR® PFP, 1.8 µm particle size 1.8 µm · UHPLC								
Analytical EC columns								
	2 mm	760431.20	760433.20	760435.20	760436.20		760438.20	
	3 mm	760431.30	760433.30		760436.30			
	4 mm	760431.40	760433.40		760436.40			
	4.6 mm	760431.46	760433.46		760436.46			
EC guard columns*			4 x 2 mm: 761975.20		4 x 3 mm: 761975.30			
NUCLEODUR® PFP, 3 µm particle size 3 µm								
Analytical EC columns								
	2 mm		760443.20		760446.20	760447.20	760448.20	760449.20
	3 mm		760443.30		760446.30	760447.30	760448.30	760449.30
	4 mm		760443.40		760446.40	760447.40	760448.40	760449.40
	4.6 mm		760443.46	760445.46	760446.46	760447.46	760448.46	760449.46
EC guard columns*			4 x 2 mm: 761976.20		4 x 3 mm: 761976.30			
NUCLEODUR® PFP, 5 µm particle size 5 µm								
Analytical EC columns								
	2 mm		760453.20		760456.20	760457.20	760458.20	760459.20
	3 mm		760453.30		760456.30	760457.30	760458.30	760459.30
	4 mm		760453.40		760456.40	760457.40	760458.40	760459.40
	4.6 mm		760453.46	760455.46	760456.46	760457.46	760458.46	760459.46
EC guard columns*			4 x 2 mm: 761977.20		4 x 3 mm: 761977.30			
Preparative VarioPrep columns								
	10 mm		762210.100			762211.100		762213.100
	21 mm		762210.210			762211.210		762213.210
	32 mm							762213.320
	40 mm						762212.400	762213.400
VP guard columns***			10 x 8 mm: 762214.80		10 x 16 mm: 762214.160		15 x 32 mm: 762216.320	

EC and VarioPrep columns in packs of 1

HPLC Column NUCLEODUR® Column



Made in Germany





NUCLEODUR®
HPLC Column

NUCLEODUR® Column



NUCLEODUR® Sphinx RP bifunctional RP phase · USP L1 and L11

Eluent in column acetonitrile – water

	ID	Length → 30 mm	50 mm	75 mm	100 mm	125 mm	150 mm	250 mm
NUCLEODUR® Sphinx RP, 1.8 µm particle size 1.8 µm · UHPLC								
Analytical EC columns								
	2 mm	760821.20	760822.20	760825.20	760823.20		760824.20	
	3 mm	760821.30	760822.30		760823.30			
	4 mm	760821.40	760822.40		760823.40			
	4.6 mm	760821.46	760822.46		760823.46			
EC guard columns*			4 x 2 mm: 761920.20		4 x 3 mm: 761920.30			
NUCLEODUR® Sphinx RP, 3 µm particle size 3 µm								
Analytical EC columns								
	2 mm		760806.20		760812.20	760807.20	760805.20	760808.20
	3 mm		760806.30		760812.30	760807.30	760805.30	760808.30
	4 mm		760806.40		760812.40	760807.40	760805.40	760808.40
	4.6 mm		760806.46	760813.46	760812.46	760807.46	760805.46	760808.46
EC guard columns*			4 x 2 mm: 761921.20		4 x 3 mm: 761921.30			
NUCLEODUR® Sphinx RP, 5 µm particle size 5 µm								
Analytical EC columns								
	2 mm		760800.20		760809.20	760801.20	760802.20	760803.20
	3 mm		760800.30		760809.30	760801.30	760802.30	760803.30
	4 mm		760800.40		760809.40	760801.40	760802.40	760803.40
	4.6 mm		760800.46	760815.46	760809.46	760801.46	760802.46	760803.46
EC guard columns*			4 x 2 mm: 761922.20		4 x 3 mm: 761922.30			
Preparative VarioPrep columns								
	10 mm		762372.100			762375.100		762373.100
	21 mm		762372.210			762375.210		762373.210
	32 mm							762373.320
	40 mm						762371.400	762373.400
VP guard columns***			10 x 8 mm: 762390.80		10 x 16 mm: 762390.160		15 x 32 mm: 762392.320	

EC and VarioPrep columns in packs of 1

HPLC Column NUCLEODUR® Column









Made in Germany

NUCLEODUR® Column



NUCLEODUR® C₁₈ HTec base-deactivated preparative octadecyl phase · USP L1

Eluent in column acetonitrile – water

	ID	Length → 30 mm	50 mm	75 mm	100 mm	125 mm	150 mm	250 mm
NUCLEODUR® C₁₈ HTec, 1.8 µm particle size 1.8 µm · UHPLC								
Analytical EC columns								
	2 mm	760301.20	760305.20	760304.20	760306.20		760308.20	
	3 mm	760301.30	760305.30		760306.30			
	4 mm	760301.40	760305.40		760306.40			
	4.6 mm	760301.46	760305.46		760306.46			
EC guard columns*			4 x 2 mm: 761925.20		4 x 3 mm: 761925.30			
NUCLEODUR® C₁₈ HTec, 3 µm particle size 3 µm								
Analytical EC columns								
	2 mm		760321.20		760323.20	760324.20	760325.20	760326.20
	3 mm		760321.30		760323.30	760324.30	760325.30	760326.30
	4 mm		760321.40		760323.40	760324.40	760325.40	760326.40
	4.6 mm		760321.46	760322.46	760323.46	760324.46	760325.46	760326.46
EC guard columns*			4 x 2 mm: 761926.20		4 x 3 mm: 761926.30			
NUCLEODUR® C₁₈ HTec, 5 µm particle size 5 µm								
Analytical EC columns								
	2 mm		760311.20		760313.20	760314.20	760315.20	760316.20
	3 mm		760311.30		760313.30	760314.30	760315.30	760316.30
	4 mm		760311.40		760313.40	760314.40	760315.40	760316.40
	4.6 mm		760311.46	760312.46	760313.46	760314.46	760315.46	760316.46
EC guard columns*			4 x 2 mm: 761927.20		4 x 3 mm: 761927.30			
Preparative VarioPrep columns								
	10 mm		762551.100			762554.100		762556.100
	21 mm		762551.210		762553.210	762554.210		762556.210
	32 mm				762553.320		762555.320	762556.320
	40 mm						762555.400	762556.400
	50 mm				762553.500		762555.500	762556.500
VP guard columns***			10 x 8 mm: 762591.80		10 x 16 mm: 762591.160			
			15 x 32 mm: 762592.320		15 x 50 mm: 762592.500			
NUCLEODUR® C₁₈ HTec, 7 µm particle size 7 µm								
Preparative VarioPrep columns								
	10 mm		762561.100			762564.100		762566.100
	21 mm		762561.210		762563.210	762564.210		762566.210
	32 mm				762563.320		762565.320	762566.320
	40 mm						762565.400	762566.400
	50 mm				762563.500		762565.500	762566.500
VP guard columns***			10 x 8 mm: 762591.80		10 x 16 mm: 762591.160			
			15 x 32 mm: 762592.320		15 x 50 mm: 762592.500			
NUCLEODUR® C₁₈ HTec, 10 µm particle size 10 µm								
Preparative VarioPrep columns								
	10 mm		762571.100			762574.100		762576.100
	21 mm		762571.210		762573.210	762574.210		762576.210
	32 mm				762573.320		762575.320	762576.320
	40 mm						762575.400	762576.400
	50 mm				762573.500		762575.500	762576.500
VP guard columns***			10 x 8 mm: 762591.80		10 x 16 mm: 762591.160			
			15 x 32 mm: 762592.320		15 x 50 mm: 762592.500			

EC and VarioPrep columns in packs of 1

HPLC Column

NUCLEODUR® Column



Made in Germany

NUCLEODUR®
HPLC Column

NUCLEODUR® Column



NUCLEODUR® C₁₈ ec · C₈ ec · C₄ ec nonpolar phases for routine analysis · USP L1 (C₁₈) · L7 (C₈) · L26 (C₄)

Eluent in column acetonitrile – water

	ID	Length → 50 mm	75 mm	100 mm	125 mm	150 mm	250 mm
NUCLEODUR® 100-3 C₁₈ ec octadecyl phase, particle size 3 µm, 17.5 % C							
Analytical EC columns							
	2 mm	760050.20		760054.20	760051.20	760053.20	760052.20
	3 mm	760050.30		760054.30	760051.30	760053.30	760052.30
	4 mm	760050.40		760054.40	760051.40	760053.40	760052.40
	4.6 mm	760050.46	760046.46	760054.46	760051.46	760053.46	760052.46
EC guard columns* 4 x 2 mm: 761931.20 4 x 3 mm: 761931.30183www							
NUCLEODUR® 100-5 C₁₈ ec octadecyl phase, particle size 5 µm, 17.5 % C							
Analytical EC columns							
	2 mm	760004.20		760013.20	760001.20	760008.20	760002.20
	3 mm	760004.30		760013.30	760001.30	760008.30	760002.30
	4 mm	760004.40		760013.40	760001.40	760008.40	760002.40
	4.6 mm	760004.46	760035.46	760013.46	760001.46	760008.46	760002.46
EC guard columns* 4 x 2 mm: 761932.20 4 x 3 mm: 761932.30							
Preparative VarioPrep columns							
	10 mm	762003.100			762029.100		762022.100
	21 mm	762003.210			762029.210		762022.210
	32 mm						762022.320
	40 mm					762027.400	762022.400
VP guard columns** 10 x 8 mm: 762090.80 10 x 16 mm: 762090.160 15 x 32 mm: 762311.320 15 x 50 mm: 762311.500							
NUCLEODUR® 100-10 C₁₈ ec octadecyl phase, particle size 10 µm, 17.5 % C							
Preparative VarioPrep columns							
	10 mm	762011.100			762302.100		762010.100
	21 mm	762011.210			762302.210		762010.210
	32 mm						762010.320
	40 mm					762303.400	762010.400
	50 mm						762010.500
VP guard columns** 10 x 8 mm: 762090.80 10 x 16 mm: 762090.160 15 x 32 mm: 762311.320 15 x 50 mm: 762311.500							
NUCLEODUR® 100-3 C₈ ec octyl phase, particle size 3 µm, 10.5 % C							
Analytical EC columns							
	2 mm	760063.20		760059.20	760060.20		760062.20
	3 mm	760063.30		760059.30	760060.30		760062.30
	4 mm	760063.40		760059.40	760060.40		760062.40
	4.6 mm	760063.46	760064.46	760059.46	760060.46	760061.46	760062.46
EC guard columns* 4 x 2 mm: 761936.20 4 x 3 mm: 761936.30							
NUCLEODUR® 100-5 C₈ ec octyl phase, particle size 5 µm, 10.5 % C							
Analytical EC columns							
	2 mm	760700.20		760704.20	760701.20		760703.20
	3 mm	760700.30		760704.30	760701.30		760703.30
	4 mm	760700.40		760704.40	760701.40		760703.40
	4.6 mm	760700.46	760706.46	760704.46	760701.46	760702.46	760703.46
EC guard columns* 4 x 2 mm: 761937.20 4 x 3 mm: 761937.30							
Preparative VarioPrep columns							
	10 mm	762072.100			762061.100		762062.100
	21 mm	762072.210			762061.210		762062.210
	32 mm						762062.320
	40 mm					762079.400	762062.400
VP guard columns** 10 x 8 mm: 762092.80 10 x 16 mm: 762092.160 15 x 32 mm: 762321.320							

EC and VarioPrep columns in packs of 1

HPLC Column NUCLEODUR® Column



Made in Germany

NUCLEODUR® Column



NUCLEODUR® HILIC zwitterionic phase

Eluent in column acetonitrile – water (80:20, v/v)

	ID	Length → 30 mm	50 mm	75 mm	100 mm	125 mm	150 mm	250 mm
NUCLEODUR® HILIC, 1.8 µm particle size 1.8 µm · UHPLC								
Analytical EC columns								
	2 mm	760521.20	760523.20	760525.20	760526.20		760528.20	
	3 mm	760521.30	760523.30		760526.30			
	4 mm	760521.40	760523.40		760526.40			
	4.6 mm	760521.46	760523.46		760526.46			
EC guard columns*			4 x 2 mm: 761960.20		4 x 3 mm: 761960.30			
NUCLEODUR® HILIC, 3 µm particle size 3 µm								
Analytical EC columns								
	2 mm		760532.20		760534.20	760531.20	760533.20	760530.20
	3 mm		760532.30		760534.30	760531.30	760533.30	760530.30
	4 mm		760532.40		760534.40	760531.40	760533.40	760530.40
	4.6 mm		760532.46		760534.46	760531.46	760533.46	760530.46
EC guard columns*			4 x 2 mm: 761961.20		4 x 3 mm: 761961.30			
NUCLEODUR® HILIC, 5 µm particle size 5 µm								
Analytical EC columns								
	2 mm		760552.20		760554.20	760551.20	760553.20	760550.20
	3 mm		760552.30		760554.30	760551.30	760553.30	760550.30
	4 mm		760552.40		760554.40	760551.40	760553.40	760550.40
	4.6 mm		760552.46		760554.46	760551.46	760553.46	760550.46
EC guard columns*			4 x 2 mm: 761962.20		4 x 3 mm: 761962.30			

NUCLEODUR® CN / CN-RP cyano-modified high purity silica phase · USP L10

	ID	Length → 50 mm	125 mm	150 mm	250 mm
NUCLEODUR® 100-3 CN-RP particle size 3 µm; eluent in column acetonitrile – water					
Analytical EC columns					
	2 mm	760159.20	760157.20		
	3 mm		760157.30		
	4 mm			760156.40	
	4.6 mm			760156.46	
EC guard columns*		4 x 2 mm: 761941.20		4 x 3 mm: 761941.30	
NUCLEODUR® 100-5 CN-RP particle size 5 µm; eluent in column acetonitrile – water					
Analytical EC columns					
	4 mm		760153.40		760152.40
	4.6 mm		760153.46	760154.46	760152.46
EC guard columns*				4 x 3 mm: 761944.30	
NUCLEODUR® 100-5 CN particle size 5 µm; eluent in column n-heptane					
Analytical EC columns					
	4 mm		760151.40	760149.40	760150.40
	4.6 mm		760151.46	760149.46	760150.46
EC guard columns*				4 x 3 mm: 761943.30	

EC and VarioPrep columns in packs of 1

HPLC Column

NUCLEODUR® Column





Made in Germany

NUCLEODUR®
HPLC Column

NUCLEODUR® Column





NUCLEODUR® NH₂ / NH₂-RP amino-modified high purity silica · USP L8

	ID	Length → 50 mm	125 mm	150 mm	250 mm
NUCLEODUR® 100-3 NH₂-RP particle size 3 µm; eluent in column acetonitrile – water					
Analytical EC columns					
	2 mm	760740.20	760741.20		
	4.6 mm			760742.46	760739.46
EC guard columns*		4 x 2 mm: 761951.20		4 x 3 mm: 761951.30	
NUCLEODUR® 100-5 NH₂-RP particle size 5 µm; eluent in column acetonitrile – water					
Analytical EC columns					
	2 mm		760730.20		760732.20
	3 mm		760730.30		760732.30
	4 mm		760730.40		760732.40
	4.6 mm		760730.46	760731.46	760732.46
EC guard columns*		4 x 2 mm: 761953.20		4 x 3 mm: 761953.30	
NUCLEODUR® 100-5 NH₂ particle size 5 µm; eluent in column n-heptane					
Analytical EC columns					
	4 mm		760720.40		760722.40
	4.6 mm		760720.46	760721.46	760722.46
EC guard columns*		4 x 3 mm: 761952.30			
EC columns in packs of 1					

NUCLEODUR® SiOH unmodified silica for normal phase · USP L3

Eluent in column n-heptane

	ID	Length → 50 mm	125 mm	150 mm	250 mm
NUCLEODUR® 100-3 particle size 3 µm					
Analytical EC columns					
	4.6 mm	760170.46		760172.46	760173.46
EC guard columns*		4 x 3 mm: 761966.30			
NUCLEODUR® 100-5 particle size 5 µm					
Analytical EC columns					
	4 mm				760007.40
	4.6 mm	760023.46	760012.46	760007.46	
EC guard columns*		4 x 3 mm: 761967.30			
Preparative VarioPrep columns					
	10 mm	762077.100	762078.100		762007.100
	21 mm	762077.210	762078.210		762007.210
	40 mm			762075.400	762007.400
VP guard columns*		10 x 8 mm: 762094.80		10 x 16 mm: 762094.160	
		15 x 32 mm: 762330.320			
EC columns in packs of 1					

HPLC Column NUCLEOSHELL® phase overview



Made in Germany

NUCLEOSHELL® phase overview



Feature

- Chromatography 분야의 HPLC/UHPLC 컬럼
- Core shell 기술로 높은 효율성과 빠른 분리 시간
- 높은 온도에서도 효율성, peak 대칭성 유지
- 균일한 입자와 최적화된 결합기술로 재현성 우수
- 압력 안정성 : 최대 600 bar
- Particle Size : 2.7 μm (Core 1.7 μm), 5 μm (Core 3.8 μm)

Overview of NUCLEOSHELL® HPLC phases

Phase	Specification	Characteristic*	Stability	Structure
 RP 18	octadecyl, multi-encapping 7.8 % C (2.7 μm particles) 6.1 % C (5 μm particles) USP L1	A ●●●●● B ● C ●●●	pH 1, 11, suitable for LC/MS	NUCLEOSHELL® (Si-O ₂) _n
 RP 18plus	octadecyl (monomeric), multi-encapping 5.7 % C (2.7 μm particles) 4.4 % C (5 μm particles) USP L1	A ●●●●● B ●●●● C -	pH 2-9, suitable for LC/MS	NUCLEOSHELL® (Si-O ₂) _n
 Phenyl-Hexyl	phenylhexyl, multi-encapping 4.5 % C (2.7 μm particles) USP L11	A ●● B ●●●● C ●	pH 1-10, suitable for LC/MS	NUCLEOSHELL® (Si-O ₂) _n
 PFP	pentafluorophenyl, multi-encapping ~ 3 % C (2.7 μm particles) USP L43	A ●● B ●●●●● C ●●●●●	pH 1-9, suitable for LC/MS	NUCLEOSHELL® (Si-O ₂) _n
 HILIC	zwitterionic ammonium - sulfonic acid 1.3 % C (2.7 μm particles)	A ● B ●●●●● C -	pH 2-8.5, suitable for LC/MS	NUCLEOSHELL® (Si-O ₂) _n

* A = ● hydrophobic selectivity, B = ● polar / ionic selectivity, C = ● steric selectivity

HPLC Column NUCLEOSHELL® phase overview



Made in Germany

NUCLEOSHELL®
HPLC Column

NUCLEOSHELL® phase overview



Core-shell technology

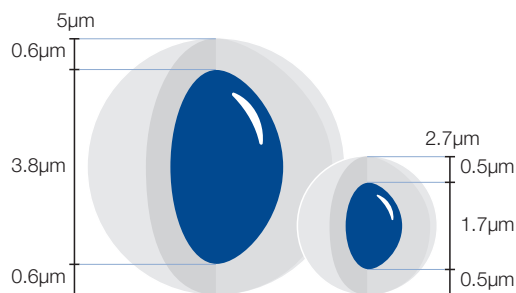

- 이산화 규소의 Solid core
- 다공성 실리카의 균일한 shell
- Totally porous material에 비해 높은 분리 효율성
- 낮은 back pressure로 기존 LC시스템에서 사용 가능
- 높은 유량에서도 Peak broadening (피크 넓어지는 현상) 없음
- 마찰열 영향 최소화

Core-shell particles vs. totally porous silica

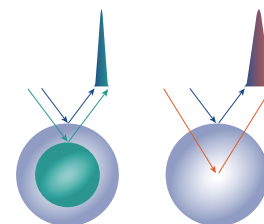

Application	Similar phases**	Interactions · retention mechanism
overall sophisticated analytical separations, e.g., analgesics, anti-inflammatory drugs, antidepressants; herbicides; phytopharmaceuticals; immunosuppressants	Kinetex® C18; Cortecs® C18; Raptor® C18; Accucore® C18; Ascentis® Express C18	hydrophobic (van der Waals interactions)
overall sophisticated analytical separations, especially for polar compounds, e.g., pharmaceuticals like antibiotics, water-soluble vitamins, organic acids	Kinetex® XB-C18; Bonshell® ASB-C18; Raptor® ARC-C18;	hydrophobic (van der Waals interactions)
aromatic and unsaturated compounds, polar compounds like pharmaceuticals, antibiotics	Ascentis® Express Phenyl-Hexyl; Kinetex® Phenyl-Hexyl; Accucore® Phenyl-Hexyl; Ultracore® Phenyl-Hexyl; Poroshell® Phenyl-Hexyl	π - π and hydrophobic
aromatic and unsaturated compounds, phenols, halogenated hydrocarbons, isomers, polar compounds like pharmaceuticals, antibiotics	Kinetex® PFP; Ascentis® Express F5; Accucore® PFP	polar (H bond), dipole-dipole, π - π and hydrophobic
hydrophilic compounds such as organic polar acids and bases, polar natural compounds	-	ionic / hydrophilic and electrostatic

** phases which provide a similar selectivity based on chemical and physical properties

HPLC Column NUCLEOSHELL® Column





Made in Germany

NUCLEOSHELL® Column



NUCLEOSHELL® RP 18 nonpolar high density phase · USP L1



Eluent in column acetonitrile – water

	ID	Length → 50 mm	100 mm	150 mm	250 mm	EC guard columns
NUCLEOSHELL® RP 18, 2.7 µm particle size 2.7 µm						
Analytical EC columns						
	2 mm	763132.20	763134.20	763136.20		763138.20
	3 mm	763132.30	763134.30	763136.30		763138.30
	4 mm	763132.40	763134.40	763136.40		763138.30
	4.6 mm	763132.46	763134.46	763136.46		763138.30
NUCLEOSHELL® RP 18, 5 µm particle size 5 µm						
Analytical EC columns						
	2 mm	763152.20	763154.20	763156.20	763157.20	763158.20
	3 mm	763152.30	763154.30	763156.30	763157.30	763158.30
	4 mm	763152.40	763154.40	763156.40	763157.40	763158.30
	4.6 mm	763152.46	763154.46	763156.46	763157.46	763158.30

EC columns in packs of 1, guard columns in packs of 3.

NUCLEOSHELL® RP 18plus C₁₈ phase with polar selectivity · USP L1

Eluent in column acetonitrile – water

	ID	Length → 50 mm	100 mm	150 mm	250 mm	EC guard columns
NUCLEOSHELL® RP 18, 2.7 µm particle size 2.7 µm						
Analytical EC columns						
	2 mm	763232.20	763234.20	763236.20		763238.20
	3 mm	763232.30	763234.30	763236.30		763238.30
	4 mm	763232.40	763234.40	763236.40		763238.30
	4.6 mm	763232.46	763234.46	763236.46		763238.30
NUCLEOSHELL® RP 18plus, 5 µm particle size 5 µm						
Analytical EC columns						
	2 mm	763252.20	763254.20	763256.20	763257.20	763258.20
	3 mm	763252.30	763254.30	763256.30	763257.30	763258.30
	4 mm	763252.40	763254.40	763256.40	763257.40	763258.30
	4.6 mm	763252.46	763254.46	763256.46	763257.46	763258.30

EC columns in packs of 1, guard columns in packs of 3.

HPLC Column NUCLEOSHELL® Column



Made in Germany

NUCLEOSHELL®
HPLC Column

NUCLEOSHELL® Column



NUCLEOSHELL® Phenyl-Hexyl nonpolar high density phase · USP L11

Eluent in column acetonitrile – water

	ID	Length → 50 mm	100 mm	150 mm	EC guard columns
NUCLEOSHELL® Phenyl-Hexyl, 2.7 µm particle size 2.7 µm					
Analytical EC columns					
	2 mm	763732.20	763734.20	763736.20	763738.20
	3 mm	763732.30	763734.30	763736.30	763738.30
	4 mm	763732.40	763734.40	763736.40	763738.30
	4.6 mm	763732.46	763734.46	763736.46	763738.30

EC columns in packs of 1, guard columns in packs of 3.

NUCLEOSHELL® PFP hydrophobic pentafluorophenyl phase · USP L43

Eluent in column acetonitrile – water

	ID	Length → 50 mm	100 mm	150 mm	EC guard columns
NUCLEOSHELL® PFP, 2.7 µm particle size 2.7 µm					
Analytical EC columns					
	2 mm	763532.20	763534.20	763536.20	763538.20
	3 mm	763532.30	763534.30	763536.30	763538.30
	4 mm	763532.40	763534.40	763536.40	763538.30
	4.6 mm	763532.46	763534.46	763536.46	763538.30

EC columns in packs of 1, guard columns in packs of 3.

NUCLEOSHELL® HILIC zwitterionic phase

Eluent in column acetonitrile – water

	ID	Length → 50 mm	100 mm	150 mm	EC guard columns
NUCLEOSHELL® HILIC, 2.7 µm particle size 2.7 µm					
Analytical EC columns					
	2 mm	763332.20	763334.20	763336.20	763338.20
	3 mm	763332.30	763334.30	763336.30	763338.30
	4 mm	763332.40	763334.40	763336.40	763338.30
	4.6 mm	763332.46	763334.46	763336.46	763338.30

EC columns in packs of 1, guard columns in packs of 3.

Phase overview for special separations



Separation / mechanism	Recommended column	Specification of the phase
Environmental analysis		
Anion exchange chromatography of inorganic anions	NUCLEOGEL® Anion I	Strongly basic polymer-based anion exchanger
	NUCLEOSIL® Anion II	Strongly basic silica-based anion exchangerRP chromatography of PAHs
	NUCLEODUR® C ₁₈ PAH	NUCLEODUR® polymer-coated with C ₁₈ groups USP L1
	NUCLEOSIL® 100-5 C ₁₈ PAH	NUCLEOSIL® 100 polymer-coated with C ₁₈ groups USP L1
Enantiomer separation		
Polar and π - π interactions	NUCLEOCEL DELTA	Silica-based modified cellulose phases USP L40
Formation of inclusion complexes	NUCLEODEX α -PM, β -PM, γ -PM and β -OH	Silica-based permethylated and underivatized cyclodextrin phases USP L45
Enantioselective binding to chiral protein surface structures	RESOLVOSIL BSA-7	Silica-based protein phase (BSA)
Ligand exchange	NUCLEOSIL® CHIRAL-1	Covalently bonded amino acid – Cu(II) complexes USP L32
Charge-transfer, dipole-dipole interactions and others	NUCLEOSIL® CHIRAL-2 NUCLEOSIL® CHIRAL-3	Silica-based brush type phases USP L36
Separation of biological macromolecules		
Anion exchange chromatography of oligonucleo-tides and nucleic acids	NUCLEOGEN® DEAE	Silica-based DEAE anion exchanger
Anion exchange chromatography of peptides, large proteins and oligonucleotides	NUCLEOGEL® SAX	Polymer-based Strongly basic anion exchanger USP L23
Cation exchange chromatography of proteins, peptides and carbohydrates	NUCLEOGEL® SCX	Polymer-based strong cation exchanger USP L22
Reversed phase chromatography of proteins, pep-tides and oligonucleotides	NUCLEOSIL® MPN	Monomerically bonded alkyl chains on silica USP L1 / USP L26
	NUCLEOSIL® PPN	Polymerically bonded alkyl chains on silica USP L1
	NUCLEOGEL® RP 300	Polystyrene – divinylbenzene polymer USP L21
Reversed phase chromatography of small mole-cules	NUCLEOGEL® RP 100	Small pore macroporous PS-DVB polymer USP L21
Food analysis · sugars		
RP chromatography of mono- and oligosaccharides	NUCLEOSIL® Carbohydrate	Silica-based special amino phase USP L8
Separation of sugars, alcohols, org. acids based on ion exclusion, ion exchange, size exclusion, ligand exchange, NP and RP effects	NUCLEOGEL® SUGAR 810 H, Ca	Resins with sulfonic acid modification in different ionic forms H form USP L17 / Ca form L19 / Pb form L34 / Na form L58
Separation of sugars, alcohols, org. acids based on steric exclusion, ligand exchange and partition effects	NUCLEOGEL® SUGAR Ca, Na, Pb NUCLEOGEL® ION 300 OA	
Gel permeation chromatography (GPC)		
Water-insoluble compounds	NUCLEOGEL® GPC	Polystyrene – divinylbenzene polymer

Application



MN Column은 3,000개 이상의 다양한 Application database를 가지고 있습니다.

100년 이상의 오랜 경험과 노하우로 크로마토그래피 분야의 연구, 실험, 분석 등에 최적의 솔루션을 제공합니다.

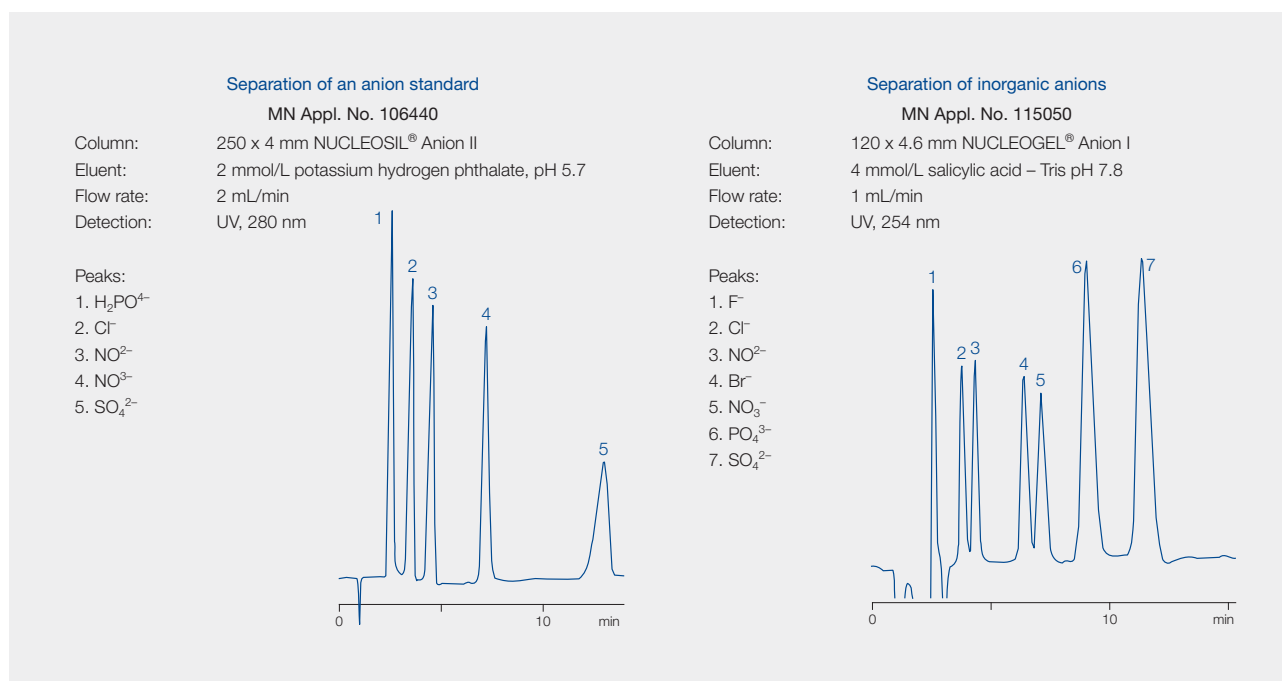
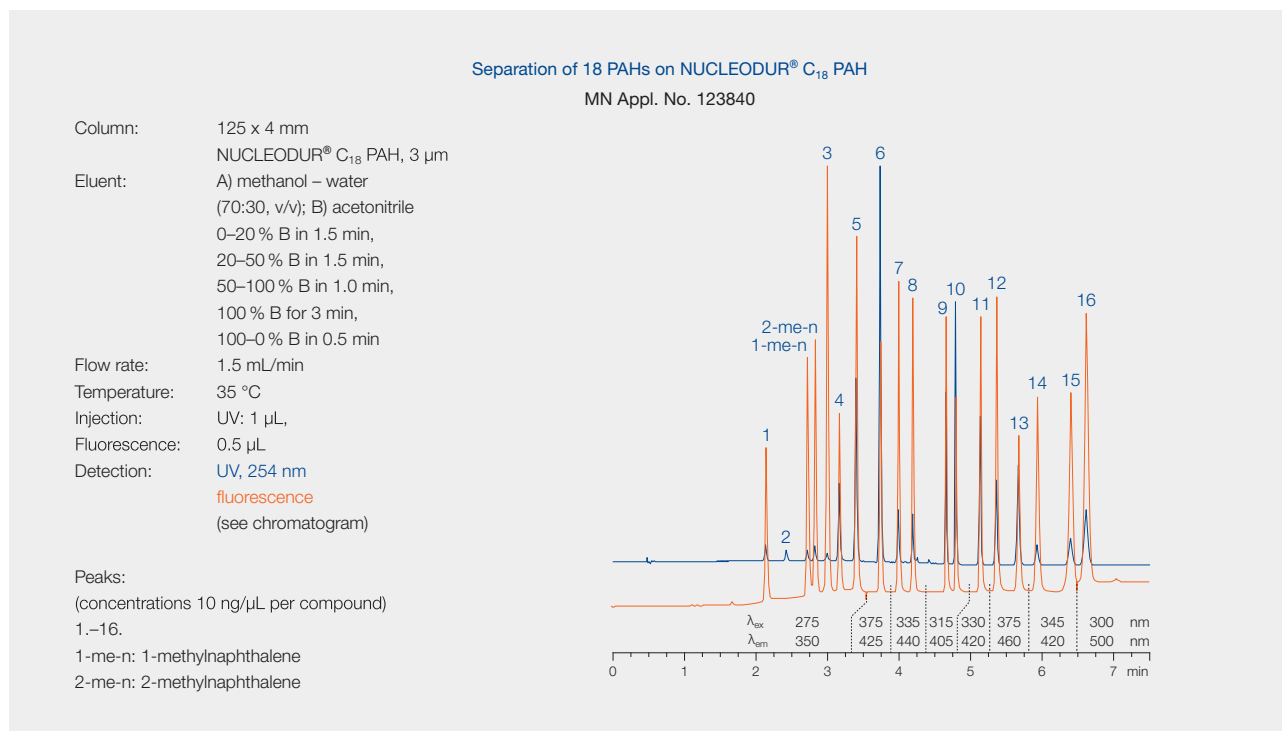



USP Listing

USP listing of MN GC Phases

Code	Specifications	MN GC phases
USP G1 / G2	dimethylpolysiloxane oil	OPTIMA® 1
		OPTIMA® 1 MS
		OPTIMA® 1 MS Accent
		OPTIMA® 1-TG
		PERMABOND® SE-30
		PERMABOND® P-100
USP G3	50 % phenyl - 50 % methylpolysiloxane	OPTIMA® 17
		OPTIMA® 17 MS
		OPTIMA® 17-TG
USP G6	trifluoropropylmethylpolysiloxane	OPTIMA® 210
USP G7	50 % 3-cyanopropyl - 50 % phenylmethylpolysiloxane	OPTIMA® 225
USP G16	polyethylene glycol (average molecular weight ~ 15 000); high molecular weight compound of polyethylene glycol and diepoxide	OPTIMA® WAX
		OPTIMA WAXplus®
		PERMABOND® CW 20 M
		PERMABOND® CW 20 M-DEG
		FS-CW 20 M-AM
USP G19	25 % phenyl-25 % cyanopropyl-50 % methylsiloxane	OPTIMA® 225
USP G25	high molecular weight compound of polyethylene glycol and diepoxide, which is esterified with terephthalic acid	OPTIMA® FFAP
		OPTIMA® FFAPplus
		PERMABOND® FFAP
USP G27	5 % phenyl – 95 % methylpolysiloxane	OPTIMA® 5
		OPTIMA® 5 Amine
		OPTIMA® 5 HT
		OPTIMA® 5 MS
		OPTIMA® 5 MS Accent
		PERMABOND® SE-52
USP G28	25 % phenyl – 75 % methylpolysiloxane	OPTIMA® 35 MS
USP G32	20 % phenylmethyl – 80 % dimethylpolysiloxane	OPTIMA® 35 MS
USP G35	high molecular weight compound of polyethylene glycol and diepoxide, which is esterified with nitroterephthalic acid	OPTIMA® FFAP
		OPTIMA® FFAPplus
		PERMABOND® FFAP
USP G36	1 % vinyl-5 % phenylmethylpolysiloxane	OPTIMA® 5
		OPTIMA® 5 Amine
		OPTIMA® 5 HT
		OPTIMA® 5 MS
		OPTIMA® 5 MS Accent
		PERMABOND® SE-54 HKW
USP G38	dimethylpolysiloxane oil	OPTIMA® 1
		OPTIMA® 1 MS
		OPTIMA® 1 MS Accent
		OPTIMA® 1-TG
		PERMABOND® SE-30
		PERMABOND® P-100
USP G42	35 % phenyl – 65 % dimethylpolysiloxane	OPTIMA® 35 MS
USP G43	6 % cyanopropylphenyl – 94 % dimethylpolysiloxane	OPTIMA® 1301
		OPTIMA® 1301 MS
		OPTIMA® 624
USP G46	14 % cyanopropylphenyl – 86 % methylpolysiloxane	OPTIMA® 624 LB
		OPTIMA® 1701
USP G49	proprietary derivatized phenyl groups on a polysiloxane backbone	OPTIMA® 1701 MS
		OPTIMA® 6-3

Separation properties



Separation properties of OPTIMA[®] phases

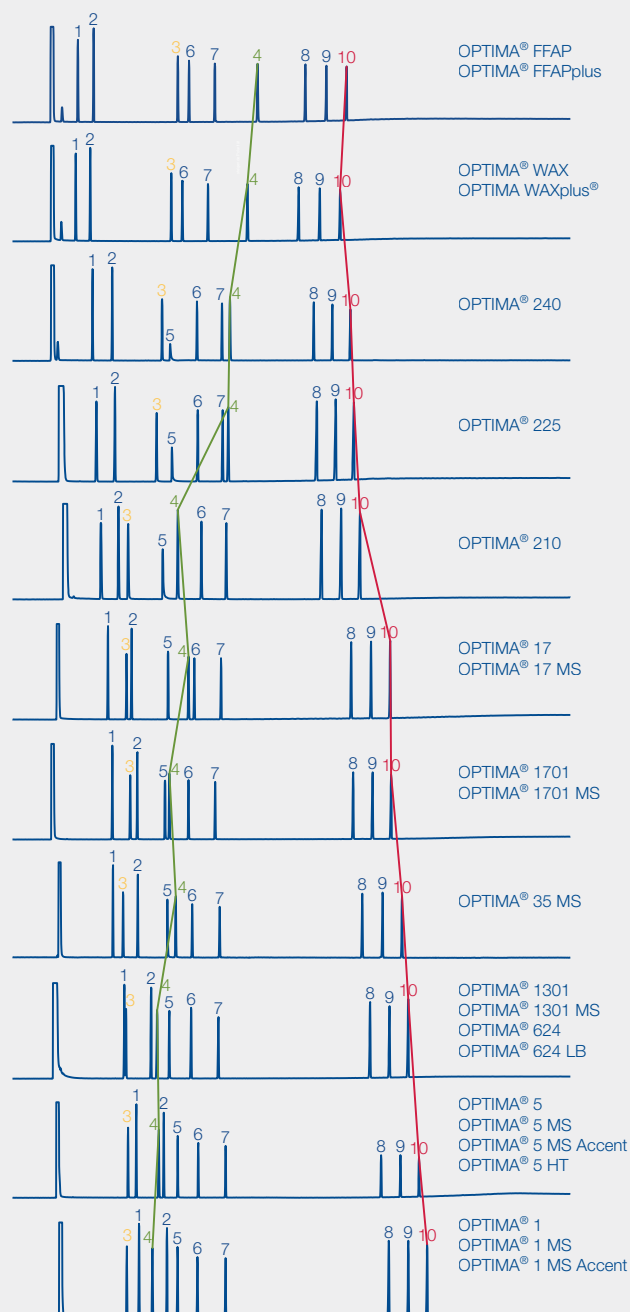

- Peaks:
- | | |
|--------------------|-----------------------|
| 1. Undecane | 6. Methyl decanoate |
| 2. Dodecane | 7. Methyl undecanoate |
| 3. Octanol | 8. Henicosane |
| 4. Dimethylaniline | 9. Docosane |
| 5. Decylamine | 10. Tricosane |

All columns: 0.25 µm film, 30 m x 0.25 mm ID
 Sample: MN OPTIMA[®] test mixture (REF 722316)
 Injection: 1.0 µL, split 15 mL/min
 Carrier gas: 0.80 bar He
 Temperature: 80 °C T_{max} (isothermal), 8 °C/min (20 min T_{max})
 Detector: FID 260–280 °C

GC Column OPTIMA® phase overview



Made in Germany

OPTIMA® phase overview



Feature

- MN사의 대표 GC Column
- 우수한 분리능
- 뛰어난 안정성 및 재현성
- Phase의 우수한 내구성으로 컬럼의 오랜 수명
- 고온에서도 낮은 Bleed를 나타냄
- 극성에서 비극성까지 약 50여개의 GC phases
- 다양한 규격으로 여러 응용분야에 적합

Overview of OPTIMA® GC phases

Phase	Composition	Relative polarity ¹	Maximum temperature ²
OPTIMA®1	100 % dimethylpolysiloxane		340 / 360 °C
OPTIMA®1 MS			
OPTIMA®1 MS Accent			
OPTIMA® 5	5 % phenyl – 95 % methylpolysiloxane		340 / 360 °C
OPTIMA® 5 MS	5 % diphenyl – 95 % dimethylpolysiloxane		340 / 360 °C
OPTIMA® 5 MS Accent	silarylene phase with selectivity similar to 5 % diphenyl – 95 % dimethylpolysiloxane		340 / 360 °C
OPTIMA® XLB	silarylene phase like above, optimized silarylene content for low bleeding		340 / 360 °C
OPTIMA® δ-3	phase with autoselectivity		340 / 360 °C
OPTIMA® δ-6	phase with autoselectivity		340 / 360 °C

¹ = nonpolar, = polar

² First temperature (long term temperature) for isothermal operation, second value for the max. temperature (short term temperature) in a temperature program. Please note that for columns with 0.53 mm ID and for columns with thicker films temperature limits are generally lower. For details refer to the description of individual phases.

³ Phases which provide a similar selectivity based on chemical and physical properties



OPTIMA® phase overview

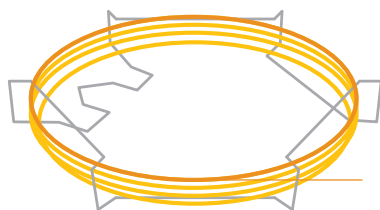

With integrated guard column e.g.,
REF 726600.30V1

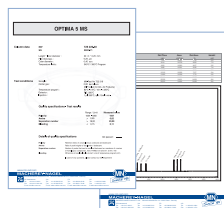

GC cages

- GC cage의 표준 크기는 7 inch
- 요청시 5 inch (13 cm) cage 제공 가능

Scope of delivery

- 각 컬럼은 개별적으로 테스트된 인증서와 지침서가 함께 제공
- GC 컬럼의 양 끝단은 Septa로 sealing되어 있음
- Fitting과 Ferrule은 별도 구매 필요

Integrated guard column



- 컬럼의 수명을 연장하기 위해 통합형 guard column을 추가할 수 있는 옵션 제공
- 모든 GC 컬럼은 비활성화된 10m guard column과 함께 사용 가능

Structure	USP	Similar phases ³
$\left[\begin{array}{c} \text{CH}_3 \\ \\ \text{O}-\text{Si} \\ \\ \text{CH}_3 \end{array} \right]_n$	G1 / G2 / G38	PERMABOND® SE-30, OV-1, DB-1, SE-30, HP-1, SPB™-1, CP-Sil 5 CB, Rtx®-1, 007-1, BP1, MDN-1, AT™-1, ZB-1, OV-101 5 % diphenyl – 95 % dimethylpolysiloxane
$\left[\begin{array}{c} \text{CH}_3 \\ \\ \text{O}-\text{Si} \\ \\ \text{C}_6\text{H}_5 \end{array} \right]_m \left[\begin{array}{c} \text{CH}_3 \\ \\ \text{O}-\text{Si} \\ \\ \text{CH}_3 \end{array} \right]_n$	G27 / G36	PERMABOND® SE-52, SE-54, SE-52, HP-5, SPB™-5, CP-Sil 8, Rtx®-5, 007-5, BP5, MDN-5, AT™-5, ZB-5
$\left[\begin{array}{c} \text{C}_6\text{H}_5 \\ \\ \text{O}-\text{Si} \\ \\ \text{C}_6\text{H}_5 \end{array} \right]_m \left[\begin{array}{c} \text{CH}_3 \\ \\ \text{O}-\text{Si} \\ \\ \text{CH}_3 \end{array} \right]_n$	G27 / G36	DB-5, DB-5MS, HP-5MS, Ultra-2, Equity™-5, CP-Sil 8CB low bleed/MS, Rxi®-5MS, Rtx®-5SIL-MS, Rtx®-5MS, 007-5MS, BPX™5, MDN-5S, AT™-5MS, VF-5MS
$\left[\begin{array}{c} \text{CH}_3 \quad \text{CH}_3 \\ \quad \\ \text{Si} \text{---} \text{C}_6\text{H}_4 \text{---} \text{Si} \text{---} \text{O} \\ \quad \\ \text{CH}_3 \quad \text{CH}_3 \end{array} \right]_n \left[\begin{array}{c} \text{CH}_3 \\ \\ \text{Si} \text{---} \text{O} \\ \\ \text{CH}_3 \end{array} \right]_o$	G27 / G36	
$\left[\begin{array}{c} \text{CH}_3 \quad \text{CH}_3 \\ \quad \\ \text{Si} \text{---} \text{C}_6\text{H}_4 \text{---} \text{Si} \text{---} \text{O} \\ \quad \\ \text{CH}_3 \quad \text{CH}_3 \end{array} \right]_n \left[\begin{array}{c} \text{CH}_3 \\ \\ \text{Si} \text{---} \text{O} \\ \\ \text{CH}_3 \end{array} \right]_o$	-	DB-XLB, Rxi®-XLB, Rtx®-XLB, MDN-12, VF-XMS
	G49	no similar phases
	-	no similar phases

OPTIMA® phase overview

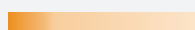
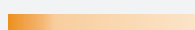
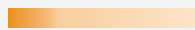
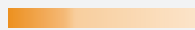
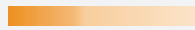

Overview of OPTIMA® GC phases

Phase	Composition	Relative polarity ¹	Maximum temperature ²
OPTIMA® 1301	6 % cyanopropylphenyl – 94 % dimethyl-polysiloxane		300 / 320 °C
OPTIMA® 1301 MS	silarylene phase with low bleeding: polarity similar to 6 % cyanopropylphenyl – 94 % dimethylpolysiloxane		300 / 320 °C
OPTIMA® 624	6 % cyanopropylphenyl – 94 % dimethyl-polysiloxane		280 / 300 °C
OPTIMA® 624 LB	like above, phase with low bleeding		
OPTIMA® 1701	14 % cyanopropylphenyl – 86 % dimethylpolysiloxane		280 / 300 °C
OPTIMA® 1701MS	silarylene phase with low bleeding: polarity similar to 14 % cyanopropylphenyl – 86 % dimethylpolysiloxane		
OPTIMA® 35 MS	silarylene phase with selectivity similar to 35 % diphenyl – 65 % dimethylpolysiloxane		360 / 370 °C
OPTIMA® 17	phenylmethylpolysiloxane, 50 % phenyl		320 / 340 °C
OPTIMA® 17 MS	silarylene phase with selectivity similar to 50 % phenyl – 50 % methylpolysiloxane		340 / 360 °C

¹  = nonpolar,  = polar

² First temperature (long term temperature) for isothermal operation, second value for the max. temperature (short term temperature) in a temperature program. Please note that for columns with 0.53 mm ID and for columns with thicker films temperature limits are generally lower. For details refer to the description of individual phases.

³ Phases which provide a similar selectivity based on chemical and physical properties

OPTIMA® phase overview



Structure	USP	Similar phases ³
$\left[\begin{array}{c} \text{C}_6\text{H}_5 \\ \\ \text{O}-\text{Si} \\ \\ \text{NC}-(\text{CH}_2)_3 \end{array} \right]_m \left[\begin{array}{c} \text{CH}_3 \\ \\ \text{O}-\text{Si} \\ \\ \text{CH}_3 \end{array} \right]_n$	G43	HP-1301, DB-1301, SPB™-1301, Rtx®-1301, CP-1301, 007-1301
$\left[\begin{array}{c} \text{NC}-(\text{CH}_2)_3 \\ \\ \text{Si}-\text{O} \\ \\ \text{NC}-(\text{CH}_2)_3 \end{array} \right]_m \left[\begin{array}{c} \text{CH}_3 \quad \text{CH}_3 \\ \quad \\ \text{Si}-\text{C}_6\text{H}_4-\text{Si}-\text{O} \\ \quad \\ \text{CH}_3 \quad \text{CH}_3 \end{array} \right]_{2m} \left[\begin{array}{c} \text{CH}_3 \\ \\ \text{Si}-\text{O} \\ \\ \text{CH}_3 \end{array} \right]_n$	G43	VF-1301ms, Rxi®-1301SIL MS, TG-1301MS
$\left[\begin{array}{c} \text{C}_6\text{H}_5 \\ \\ \text{O}-\text{Si} \\ \\ \text{NC}-(\text{CH}_2)_3 \end{array} \right]_m \left[\begin{array}{c} \text{CH}_3 \\ \\ \text{O}-\text{Si} \\ \\ \text{CH}_3 \end{array} \right]_n$	G43	HP-624, HP-VOC, DB-624, DB-VRX, SPB™-624, CP-624, Rtx®-624, Rtx®-Volatiles, 007-624, BP624, VOCOL
$\left[\begin{array}{c} \text{C}_6\text{H}_5 \\ \\ \text{O}-\text{Si} \\ \\ \text{NC}-(\text{CH}_2)_3 \end{array} \right]_m \left[\begin{array}{c} \text{CH}_3 \\ \\ \text{O}-\text{Si} \\ \\ \text{CH}_3 \end{array} \right]_n$	G46	OV-1701, DB-1701, CP-Sil 19 CB, HP-1701, Rtx®-1701, SPB™-1701, 007-1701, BP10, ZB-1701
$\left[\begin{array}{c} \text{NC}-(\text{CH}_2)_3 \\ \\ \text{Si}-\text{O} \\ \\ \text{NC}-(\text{CH}_2)_3 \end{array} \right]_m \left[\begin{array}{c} \text{CH}_3 \quad \text{CH}_3 \\ \quad \\ \text{Si}-\text{C}_6\text{H}_4-\text{Si}-\text{O} \\ \quad \\ \text{CH}_3 \quad \text{CH}_3 \end{array} \right]_{2m} \left[\begin{array}{c} \text{CH}_3 \\ \\ \text{Si}-\text{O} \\ \\ \text{CH}_3 \end{array} \right]_n$	G46	VF-1701ms, TG-1701MS, OV-1701, DB-1701, HP-1701, Rtx®-1701, SPB™-1701, CP Sil 19 CB, 007-1701, BP10, ZB-1701
$\left[\begin{array}{c} \text{C}_6\text{H}_5 \\ \\ \text{Si}-\text{O} \\ \\ \text{C}_6\text{H}_5 \end{array} \right]_m \left[\begin{array}{c} \text{CH}_3 \quad \text{CH}_3 \\ \quad \\ \text{Si}-\text{C}_6\text{H}_4-\text{Si}-\text{O} \\ \quad \\ \text{CH}_3 \quad \text{CH}_3 \end{array} \right]_n \left[\begin{array}{c} \text{CH}_3 \\ \\ \text{Si}-\text{O} \\ \\ \text{CH}_3 \end{array} \right]_o$	G28 / G32 / G42	DB-35 MS, HP-35, SPB™-35, Rxi®-35SIL MS, Rtx-35, 007-35, BPX™-35, MDN-35, AT™-35 MS, ZB-35, OV-11, VF-35 MS
$\left[\begin{array}{c} \text{CH}_3 \\ \\ \text{O}-\text{Si} \\ \\ \text{C}_6\text{H}_5 \end{array} \right]_m$	G3	OV-17, DB-17, HP-50+, HP-17, SPB™-50, SP-2250, Rxi®-17, Rtx®-50, CP-Sil 24 CB, 007-17, ZB-50
$\left[\begin{array}{c} \text{CH}_3 \quad \text{CH}_3 \\ \quad \\ \text{O}-\text{Si}-\text{C}_6\text{H}_4-\text{C}_6\text{H}_4-\text{Si} \\ \quad \\ \text{CH}_3 \quad \text{CH}_3 \end{array} \right]_m \left[\begin{array}{c} \text{C}_6\text{H}_5 \\ \\ \text{O}-\text{Si} \\ \\ \text{C}_6\text{H}_5 \end{array} \right]_n$	G3	OV-17, AT™-50, BPX™-50, DB-17, DB-17ms, HP-50+, HP-17, SPB™-50, SPB™-17, SP-2250, Rtx®-50, CP-Sil 24 CB, 007-17, VF-17ms, ZB-50

OPTIMA® phase overview



Overview of OPTIMA® GC phases

Phase	Composition	Relative polarity ¹	Maximum temperature ²
OPTIMA® 210	trifluoropropylmethylpolysiloxane (50 % trifluoropropyl)		260 / 280 °C
OPTIMA® 225	50 % cyanopropylmethyl – 50 % phenyl- methylpolysiloxane		260 / 280 °C
OPTIMA® 240	33 % cyanopropylmethyl – 67 % dimeth- ylpolysiloxan		260 / 280 °C
OPTIMA® WAX	polyethylene glycol 20 000 Da		240 / 250 °C
OPTIMA WAXplus®	polyethylene glycol with optimized cross-linking		260 / 270 °C
OPTIMA® FFAP	polyethylene glycol 2-nitroterephthalate		250 / 260 °C
OPTIMA® FAPplus	polyethylene glycol 2-nitroterephthalate with optimized cross-linking		250 / 260 °C

¹  = nonpolar,  = polar

² First temperature (long term temperature) for isothermal operation, second value for the max. temperature (short term temperature) in a temperature program. Please note that for columns with 0,53 mm ID and for columns with thicker films temperature limits are generally lower. For details refer to the description of individual phases.

³ Phases which provide a similar selectivity based on chemical and physical properties

OPTIMA® phase overview



Structure	USP	Similar phases ³
$\left[\begin{array}{c} \text{CH}_3 \\ \\ \text{O}-\text{Si} \\ \\ \text{F}_3\text{C}-(\text{CH}_2)_2 \end{array} \right]_n$	G6	OV-210, DB-210, Rtx®-200, 007-210
$\left[\begin{array}{c} \text{CH}_3 \\ \\ \text{O}-\text{Si} \\ \\ \text{NC}-(\text{CH}_2)_3 \end{array} \right]_m \quad \left[\begin{array}{c} \text{CH}_3 \\ \\ \text{O}-\text{Si} \\ \\ \text{C}_6\text{H}_5 \end{array} \right]_n$ <p style="text-align: center;">$m = n$</p>	G7 / G19	DB-225, HP-225, OV-225, Rtx®-225, CP-Sil 43, 007-225, BP225
$\left[\begin{array}{c} \text{CH}_3 \\ \\ \text{O}-\text{Si} \\ \\ \text{NC}-(\text{CH}_2)_3 \end{array} \right]_m \quad \left[\begin{array}{c} \text{CH}_3 \\ \\ \text{O}-\text{Si} \\ \\ \text{CH}_3 \end{array} \right]_n$	-	no similar phases
$\text{H} \left[\begin{array}{cc} \text{H} & \text{H} \\ & \\ \text{O}-\text{C} & -\text{C} \\ & \\ \text{H} & \text{H} \end{array} \right]_n \text{OH}$	G16	PERMABOND® CW 20 M, DB-Wax, Supelcowax, HP-Wax, HP-INNOWAX, Rtx-Wax, CP-Wax 52 CB, Stabilwax, 007-CW, BP20, AT-Wax, ZB-Wax DB-Wax, Supelcowax, HP-Wax, HP-INNOWAX, Rtx-Wax, CP-Wax 52 CB, Stabilwax, 007-CW, BP20, AT-Wax, ZB-Wax
$\left[\begin{array}{c} \text{O} \\ \\ \text{C} \\ \\ \text{O}_2\text{N} \end{array} \text{C}_6\text{H}_4 \text{C} \begin{array}{c} \text{O} \\ \\ \text{C} \\ \\ \text{O} \end{array} (\text{OCH}_2\text{CH}_2)_m \text{O} \right]_n$	G35 / G25	PERMABOND® FFAP, DB-FFAP, HP-FFAP, CP-Wax 58 FFAP CB, 007-FFAP, CP-FFAP CB, Nukol™, AT-1000, SPB-1000, BP21, OV-351 DB-FFAP, HP-FFAP, CP-SIL 58 CB, 007-FFAP, CP-FFAP CB, Nukol™

OPTIMA® Column



OPTIMA® 1 100 % dimethylpolysiloxane · USP G1 / G2 / G38

- Nonpolar phase

	Length → 10 m	12 m	15 m	20 m	25 m	30 m	50 m	60 m
0.1 mm ID (0.4 mm OD)								
0.10 µm film	726024.10			726024.20				
0.40 µm film				726025.20				
0.2 mm ID (0.4 mm OD)								
0.10 µm film					726832.25			
0.20 µm film		726834.12			726834.25		726834.50	
0.35 µm film		726837.12			726837.25		726837.50	
0.50 µm film							726839.50	
0.25 mm ID (0.4 mm OD)								
0.10 µm film	726038.10		726038.15		726038.25	726038.30		726038.60
0.25 µm film	726050.10		726050.15		726050.25	726050.30	726050.50	726050.60
0.50 µm film	726081.10				726081.25	726081.30	726081.50	726081.60
1.00 µm film					726802.25	726802.30	726802.50	726802.60
0.32 mm ID (0.5 mm OD)								
0.10 µm film	726301.10				726301.25	726301.30	726301.50	726301.60
0.25 µm film	726302.10		726302.15		726302.25	726302.30	726302.50	726302.60
0.35 µm film					726821.25	726821.30	726821.50	726821.60
0.50 µm film	726304.10				726304.25	726304.30	726304.50	726304.60
1.00 µm film	726323.10		726323.15		726323.25	726323.30	726323.50	726323.60
3.00 µm film					726805.25	726805.30	726805.50	726805.60
5.00 µm film	726931.10				726931.25	726931.30	726931.50	
0.53 mm ID (0.8 mm OD)								
0.50 µm film			726519.15		726519.25	726519.30		
1.00 µm film	726529.10		726529.15		726529.25	726529.30		
2.00 µm film	726521.10				726521.25	726521.30	726521.50	
5.00 µm film	726926.10				726926.25	726926.30	726926.50	



OPTIMA® Column

OPTIMA® 1 MS 100 % dimethylpolysiloxane · USP G1 / G2 / G38

- Selectivity identical to OPTIMA® 1, Phase with low bleeding

	Length → 12 m	15 m	25 m	30 m	50 m	60 m
0.2 mm ID (0.4 mm OD)						
0.20 µm film		726201.25		726201.50		
0.35 µm film	726203.12					
0.25 mm ID (0.4 mm OD)						
0.25 µm film		726205.15		726205.30		726205.60
0.32 mm ID (0.5 mm OD)						
0.25 µm film				726202.30		726202.60

OPTIMA® 1 MS Accent 100 % dimethylpolysiloxane · USP G1 / G2 / G38

- Selectivity identical to OPTIMA® 1, nonpolar phase
- Lowest column bleed
- Solvent rinsing for removal of impurities applicable
- Increased sensitivity due to an unmatched low background level

	Length → 15 m	25 m	30 m	50 m	60 m
0.2 mm ID (0.4 mm OD)					
0.20 µm film		725801.25		725801.50	
0.25 mm ID (0.4 mm OD)					
0.25 µm film	725805.15		725805.30		725805.60
0.50 µm film			725806.30		725806.60
0.32 mm ID (0.5 mm OD)					
0.25 µm film			725802.30		725802.60
0.50 µm film			725807.30		725807.60

GC Column OPTIMA® Column



Made in Germany

OPTIMA® Column



OPTIMA® 5 5 % phenyl – 95 % methylpolysiloxane · USP G27 / G36

- Nonpolar phase

	Length → 10 m	15 m	25 m	30 m	50 m	60 m
0.1 mm ID (0.4 mm OD)						
0.10 µm film	726846.10					
0.2 mm ID (0.4 mm OD)						
0.10 µm film			726854.25			
0.20 µm film			726857.25		726857.50	
0.35 µm film			726860.25		726860.50	
0.50 µm film			726863.25		726863.50	
0.25 mm ID (0.4 mm OD)						
0.10 µm film			726911.25	726911.30	726911.50	726911.60
0.25 µm film	726056.10	726056.15	726056.25	726056.30	726056.50	726056.60
0.35 µm film			726623.25	726623.30	726623.50	726623.60
0.50 µm film			726099.25	726099.30	726099.50	726099.60
1.00 µm film			726807.25	726807.30	726807.50	726807.60
0.32 mm ID (0.5 mm OD)						
0.10 µm film	726313.10	726313.15	726313.25	726313.30	726313.50	726313.60
0.25 µm film		726314.15	726314.25	726314.30	726314.50	726314.60
0.35 µm film			726628.25	726628.30	726628.50	726628.60
0.50 µm film			726316.25	726316.30	726316.50	726316.60
1.00 µm film		726325.15	726325.25	726325.30	726325.50	726325.60
3.00 µm film			726809.25	726809.30	726809.50	726809.60
5.00 µm film		726934.15	726934.25	726934.30	726934.50	
0.53 mm ID (0.8 mm OD)						
0.50 µm film	726523.10		726523.25	726523.30		
1.00 µm film	726541.10	726541.15	726541.25	726541.30		
2.00 µm film	726525.10		726525.25	726525.30	726525.50	726525.60
5.00 µm film	726916.10		726916.25	726916.30	726916.50	



OPTIMA® Column

OPTIMA® 5 MS 5 % diphenyl – 95 % dimethylpolysiloxane · USP G27 / G36

- Selectivity identical to OPTIMA® 5
- Phase with low bleeding

	Length → 12 m	15 m	25 m	30 m	50 m	60 m
0.2 mm ID (0.4 mm OD)						
0.20 µm film	726210.12		726210.25		726210.50	
0.35 µm film	726215.12		726215.25		726215.50	
0.25 mm ID (0.4 mm OD)						
0.25 µm film		726220.15		726220.30		726220.60
0.50 µm film				726225.30		726225.60
1.00 µm film				726226.30		726226.60
0.32 mm ID (0.5 mm OD)						
0.25 µm film				726211.30		
0.50 µm film				726213.30		
1.00 µm film			726212.25		726212.50	726212.60

OPTIMA® 5 MS Accent silarylene phase · USP G27 / G36

- Chemically bonded, cross-linked silarylene phase with polarity similar to a 5 % diphenyl – 95 % dimethylpolysiloxane phase
- Lowest column bleed, nonpolar phase, solvent rinsing for removal of impurities applicable

	Length → 12 m	15 m	25 m	30 m	50 m	60 m
m0.2 mm ID (0.4 mm OD)						
0.20 µm film			725810.25		725810.50	
0.35 µm film	725815.12				725815.50	
0.25 mm ID (0.4 mm OD)						
0.25 µm film		725820.15		725820.30		725820.60
0.50 µm film				725825.30		725825.60
1.00 µm film				725826.30		725826.60
0.32 mm ID (0.5 mm OD)						
0.25 µm film				725811.30		725811.60
0.50 µm film				725813.30		
1.00 µm film			725812.25			725812.60

OPTIMA® Column



OPTIMA® XLB silarylene phase

- Chemically bonded, cross-linked silarylene phase, optimized silarylene content for lowest column bleed, nonpolar phase, perfect inertness for basic compounds, solvent rinsing for removal of impurities applicable

	Length → 30 m	60 m
0.25 mm ID (0.4 mm OD)		
0.25 µm film	725850.30	725850.60

OPTIMA® δ-3 polysiloxane phase with autoselectivity · USP G49

- Medium polar without CN groups
- Autoselectivity resulting in a polarity range from approximately the nonpolar OPTIMA® 5 to the midpolar OPTIMA® 1701
- Analytes determine the polarity of the phase

	Length → 10 m	20 m	25 m	30 m	50 m	60 m
0.1 mm ID (0.4 mm OD)						
0.10 µm film	726410.10	726410.20				
0.2 mm ID (0.4 mm OD)						
0.20 µm film			726400.25		726400.50	
0.25 mm ID (0.4 mm OD)						
0.25 µm film				726420.30		726420.60
0.50 µm film				726421.30		
0.32 mm ID (0.5 mm OD)						
0.25 µm film				726440.30		726440.60
0.35 µm film				726441.30		726441.60
1.00 µm film				726442.30		726442.60
0.53 mm ID (0.8 mm OD)						
1.00 µm film				726443.30		



OPTIMA® Column

OPTIMA® δ-6 polysiloxane phase with autoselectivity

- Medium polar without CN groups
- Autoselectivity resulting in a polarity range from approximately the midpolar OPTIMA® 17 to the polar OPTIMA® 210
- Analytes determine the polarity of the phase

	Length → 10 m	25 m	30 m	50 m	60 m
0.1 mm ID (0.4 mm OD)					
0.10 µm film	726490.10				
0.2 mm ID (0.4 mm OD)					
0.20 µm film		726465.25		726465.50	
0.25 mm ID (0.4 mm OD)					
0.25 µm film			726470.30		726470.60
0.32 mm ID (0.5 mm OD)					
0.25 µm film			726480.30		726480.60
0.35 µm film			726481.30		726481.60
1.00 µm film			726482.30		726482.60
0.53 mm ID (0.8 mm OD)					
1.00 µm film			726483.30		

OPTIMA® 1301 6 % cyanopropyl-phenyl – 94 % dimethylpolysiloxane · USP G43

- Midpolar phase

	Length → 25 m	30 m	50 m	60 m
0.25 mm ID (0.4 mm OD)				
0.25 µm film	726771.25	726771.30	726771.50	726771.60
0.32 mm ID (0.5 mm OD)				
0.25 µm film	726777.25	726777.30		726777.60
1.00 µm film		726780.30	726780.50	726780.60
0.53 mm ID (0.8 mm OD)				
1.00 µm film	726783.25			

OPTIMA® Column



OPTIMA® 1301 MS 6 % cyanopropyl-phenyl – 94 % dimethylpolysiloxane · USP G43

- Chemically bonded, cross-linked silarylene phase with selectivity similar to 6 % cyanopropyl-phenyl – 94 % dimethylpolysiloxane, symmetric substituted cyanopropylsilanes and integrated phenyl rings (silarylene)
- Midpolar phase with very low bleed
- Perfect deactivation

	Length → 30 m	60 m
0.25 mm ID (0.4 mm OD)		
0.25 µm film	726640.30	726640.60
0.32 mm ID (0.5 mm OD)		
0.25 µm film	726641.30	726641.60
1.00 µm film	726642.30	726642.60
0.53 mm ID (0.8 mm OD)		
1.00 µm film	726643.30	726643.60

OPTIMA® 624 6 % cyanopropyl-phenyl – 94 % dimethylpolysiloxane · USP G43

- Midpolar phase

OPTIMA® 624 LB 6 % cyanopropyl-phenyl – 94 % dimethylpolysiloxane

- Midpolar phase with low bleeding

	Length → 25 m	30 m	50 m	60 m
OPTIMA® 624				
0.2 mm ID (0.4 mm OD)				
1.10 µm film	726784.25			
0.25 mm ID (0.4 mm OD)				
1.40 µm film	726785.25	726785.30	726785.50	726785.60
0.32 mm ID (0.5 mm OD)				
1.80 µm film	726787.25	726787.30	726787.50	726787.60
0.53 mm ID (0.8 mm OD)				
3.00 µm film	726789.25	726789.30		
OPTIMA® 624 LB				
0.32 mm ID (0.5 mm OD)				
1.80 µm film		726786.30	726786.50	



OPTIMA® Column

OPTIMA® 1701 14 % cyanopropyl-phenyl – 86 % dimethylpolysiloxane · USP G46

- Midpolar phase, special selectivity due to high cyanopropyl content

	Length → 10 m	15 m	25 m	30 m	50 m	60 m
0.2 mm ID (0.4 mm OD)						
0.20 µm film			726841.25		726841.50	
0.25 mm ID (0.4 mm OD)						
0.25 µm film	726058.10	726058.15	726058.25	726058.30	726058.50	726058.60
0.50 µm film				726064.30		726064.60
1.00 µm film				726965.30		
0.32 mm ID (0.5 mm OD)						
0.25 µm film	726318.10	726318.15	726318.25	726318.30	726318.50	726318.60
0.35 µm film			726824.25	726824.30	726824.50	726824.60
0.50 µm film			726320.25	726320.30	726320.50	726320.60
1.00 µm film			726929.25	726929.30	726929.50	726929.60
0.53 mm ID (0.8 mm OD)						
1.00 µm film	726545.10	726545.15	726545.25	726545.30		
2.00 µm film		726735.15	726735.25	726735.30	726735.50	

OPTIMA® 1701 MS silarylene phase · USP G46

- Chemically bonded, cross-linked silarylene phase with selectivity similar to 14 % cyanopropyl-phenyl – 86 % dimethylpolysiloxane, symmetric substituted cyanopropylsilanes and integrated phenyl rings (silarylene)
- Midpolar phase with very low bleed
- Perfect deactivation

	Length → 30 m	60 m
0.25 mm ID (0.4 mm OD)		
0.25 µm film	726630.30	726630.60
0.50 µm film	726631.30	726631.60
1.00 µm film	726632.30	726632.60
0.32 mm ID (0.5 mm OD)		
0.25 µm film	726633.30	726633.60
0.50 µm film	726634.30	726634.60
1.00 µm film	726635.30	726635.60

OPTIMA® Column



OPTIMA® 35 MS silarylene phase · USP G42 / close equivalent to USP G28 / G32

- Chemically bonded cross-linked silarylene phase with selectivity similar to 35 % phenyl – 65 % methyl polysiloxane, midpolar phase, polymer without CN groups
- Very low column bleeding

	Length → 30 m	60 m
0.25 mm ID (0.4 mm OD)		
0.25 µm film	726154.30	726154.60
0.32 mm ID (0.5 mm OD)		
0.25 µm film	726157.30	726157.60

OPTIMA® 17 phenylmethylpolysiloxane (50 % phenyl) · USP G3

- Midpolar phase

	Length → 10 m	12 m	15 m	25 m	30 m	50 m	60 m
0.1 mm ID (0.4 mm OD)							
0.10 µm film	726848.10						
0.2 mm ID (0.4 mm OD)							
0.20 µm film		726065.12		726065.25		726065.50	
0.50 µm film				726066.25		726066.50	
0.25 mm ID (0.4 mm OD)							
0.15 µm film				726742.25	726742.30	726742.50	726742.60
0.25 µm film			726022.15	726022.25	726022.30	726022.50	726022.60
0.50 µm film				726067.25	726067.30	726067.50	726067.60
0.32 mm ID (0.5 mm OD)							
0.15 µm film					726755.30		
0.25 µm film				726351.25	726351.30	726351.50	726351.60
0.35 µm film				726757.25	726757.30	726757.50	726757.60
0.50 µm film				726744.25	726744.30	726744.50	726744.60
0.53 mm ID (0.8 mm OD)							
1.00 µm film	726747.10		726747.15	726747.25	726747.30		

OPTIMA® Column



OPTIMA® 17 MS silarylene phase · USP G3

- Medium polar silarylene phase with selectivity analogue to 50 % phenyl – 50 % methylpolysiloxane, no CN groups in the polymer

	Length → 30 m	60 m
0.25 mm ID (0.4 mm OD)		
0.25 µm film	726162.30	726162.60
0.32 mm ID (0.5 mm OD)		
0.25 µm film	726165.30	726165.60

OPTIMA® 210 trifluoropropyl-methylpolysiloxane (50 % trifluoropropyl) · close equivalent to USP G6

- Midpolar phase

	Length → 15 m	25 m	30 m	50 m	60 m
0.25 mm ID (0.4 mm OD)					
0.25 µm film	726871.15	726871.25	726871.30	726871.50	726871.60
0.50 µm film			726874.30	726874.50	726874.60
0.32 mm ID (0.5 mm OD)					
0.25 µm film	726877.15		726877.30	726877.50	726877.60
0.50 µm film		726880.25	726880.30	726880.50	726880.60

GC Column OPTIMA® Column



Made in Germany

OPTIMA® Column



OPTIMA® 225 50 % cyanopropyl-methyl – 50 % phenylmethylpolysiloxane · Close equivalent to USP G7 / G19

- Midpolar phase

	Length → 10 m	15 m	25 m	30 m	50 m	60 m
0.1 mm ID (0.4 mm OD)						
0.10 µm film	726080.10					
0.25 mm ID (0.4 mm OD)						
0.25 µm film		726118.15	726118.25	726118.30	726118.50	726118.60
0.32 mm ID (0.5 mm OD)						
0.25 µm film			726352.25	726352.30	726352.50	726352.60

OPTIMA® 240 33 % cyanopropyl-methyl – 67 % dimethylpolysiloxane

- Midpolar phase

	Length → 25 m	30 m	50 m	60 m
0.25 mm ID (0.4 mm OD)				
0.25 µm film		726089.30	726089.50	726089.60
0.50 µm film		726090.30		726090.60
0.32 mm ID (0.5 mm OD)				
0.25 µm film	726091.25	726091.30	726091.50	726091.60
0.35 µm film		726095.30		726095.60
0.50 µm film		726096.30		726096.60

OPTIMA® Column



OPTIMA® WAX polyethylene glycol 20 000 Da · USP G16

- Polar phase

	Length → 25 m	30 m	50 m	60 m
0.25 mm ID (0.4 mm OD)				
0.25 µm film	726600.25	726600.30	726600.50	726600.60
0.32 mm ID (0.5 mm OD)				
0.25 µm film	726321.25	726321.30	726321.50	726321.60
0.50 µm film	726296.25	726296.30	726296.50	726296.60
0.53 mm ID (0.8 mm OD)				
1.00 µm film	726549.25	726549.30		
2.00 µm film		726548.30		

OPTIMA WAXplus® cross-linked polyethylene glycol · USP G16

- Polar phase with improved cross-linking for lower column bleed and better temperature stability

	Length → 30 m	60 m
0.25 mm ID (0.4 mm OD)		
0.25 µm film	726380.30	726380.60
0.50 µm film	726381.30	726381.60
0.32 mm ID (0.5 mm OD)		
0.25 µm film	726382.30	726382.60
0.50 µm film	726383.30	726383.60

OPTIMA® Column



OPTIMA® FFAP polyethylene glycol 2-nitroterephthalate · USP G35 / close equivalent to USP G25

- Polar phase (FFAP = Free Fatty Acid Phase)

	Length → 10 m	25 m	30 m	50 m	60 m
0.1 mm ID (0.4 mm OD)					
0.10 µm film	726180.10				
0.25 mm ID (0.4 mm OD)					
0.25 µm film		726116.25	726116.30	726116.50	726116.60
0.32 mm ID (0.5 mm OD)					
0.25 µm film		726341.25	726341.30	726341.50	726341.60
0.50 µm film		726344.25	726344.30	726344.50	
0.53 mm ID (0.8 mm OD)					
0.50 µm film			726345.30		
1.00 µm film			726346.25		

OPTIMA® FFAPplus polyethylene glycol 2-nitroterephthalate · USP G35 / close equivalent to G25

- Polar phase

	Length → 30 m	60 m
0.25 mm ID (0.4 mm OD)		
0.25 µm film	726241.30	726241.60
0.50 µm film	726242.30	726242.60
0.32 mm ID (0.5 mm OD)		
0.25 µm film	726243.30	726243.60
0.50 µm film	726246.30	726246.60



Special GC Column

Capillary columns for special GC separations

- Nonpolar phase

Separation/special application	Recommended capillary column
Fast GC column with 0.10 mm ID	OPTIMA® 1, OPTIMA® 5, OPTIMA® 6-3, OPTIMA® 6-6 OPTIMA® 17, OPTIMA® 225, OPTIMA® FFAP PERMABOND® CW 20 M, PERMABOND® FFAP
Enantiomer separation cyclodextrin phases	FS-LIPODEX® A, FS-LIPODEX® B, FS-LIPODEX® C FS-LIPODEX® D, FS-LIPODEX® E, FS-LIPODEX® G
	FS-HYDRODEX β-PM, FS-HYDRODEX β-3 P, FS-HYDRODEX β-6TBDM, FS-HYDRODEX β-6TBDE, FS-HYDRODEX β-6TBDE, FS-HYDRODEX β-TBDAC, FS-HYDRODEX γ-DiMOM
Biodiesel	
Methanol analysis	OPTIMA® BioDiesel M
FAME analysis	OPTIMA® BioDiesel F
Glycerol and triglycerides	OPTIMA® BioDiesel G
Triglycerides	
	OPTIMA® 1-TG
	OPTIMA® 17-TG
High temperature GC	
	OPTIMA® 5 HT
Amines	
Polyfunctional amines	OPTIMA® 5 Amine
Amine separations	FS-CW 20 M-AM
Petrochemical products (complex hydrocarbon mixtures)	
	PERMABOND® P-100
Environmental analysis of volatile halogenated hydrocarbons	
	PERMABOND® SE-54 HKW
Silanes (monomeric, e.g., chlorosilanes)	
	PERMABOND® Silane
Diethylene glycol, e.g., for the quality control of wine	
	PERMABOND® CW 20 M-DEG

TLC (박층크로마토그래피)



Feature

- 시료 전처리 과정이 간단함
- UV, 유도체화에 따른 육안 확인 가능
- 여러 시료를 동일한 조건으로 동시 분석 가능
- 이차원적인 분리가 가능
- 즉시 사용 할 수 있는 사전 코팅된 Plate
- Mass Spectrometry와 함께 사용 가능

Most commonly used silica gel layers

SIL G

- Standard layer (soft)
- Available on glass plates, polyester, aluminum sheets
- Thicker layers for preparative TLC on glass plates

ADAMANT

- Outstanding hardness and abrasion resistance
- Excellent separation efficiency
- Low-noise background of the layer
- Available on glass plates

SIL HD

- Hard layer with good abrasion resistance
- High luminosity
- Brilliant staining properties
- Excellent separation efficiency
- Good wettability for precise colorization results
- Low-noise background of the layer
- Available on glass plates

Physical properties of backing materials

Material	Glass	Polyester	Aluminum
Thickness (approx.)	1.3 mm	0.2 mm	0.15 mm
Weight, packing and storage requirement	high	low	low
Torsional strength	ideal	low	relatively high
Temperature stability	high	max. 185 °C	high
Susceptible to breakage	yes	no	no
Can be cut with scissors	no	yes	yes
Chemical resistance of support material			
Against solvents	high	high	high
Against mineral acids and conc. ammonia	high	high	low
Stability of the binder system of NP plates in water			
Suitability for aqueous detection reagents	depends on phase	good	ALUGRAM® : low to moderate ALUGRAM® Xtra : moderate to high

TLC (박층크로마토그래피)

Several layers on glass plate

Plate size*	Plates per pack	SIL G**	REF	ADAMANT	REF	SIL HD	REF
TLC glass plates							
5 x 10 cm	50	SIL G-25	809017	ADAMANT	821040	SIL HD	809217
10 x 10 cm	25			ADAMANT	821050	SIL HD	809210
10 x 20 cm	50	SIL G-25	809012			SIL HD	809212
20 x 20 cm	25	SIL G-25	809013	ADAMANT	821060	SIL HD	809213
5 x 10 cm	50			ADAMANT UV ₂₅₄	821010	SIL HD UV ₂₅₄	809227
10 x 10 cm	25	SIL G-25 UV ₂₅₄	809020	ADAMANT UV ₂₅₄	821020	SIL HD UV ₂₅₄	809220
10 x 20 cm	50	SIL G-25 UV ₂₅₄	809022	ADAMANT UV ₂₅₄	821025	SIL HD UV ₂₅₄	809222
20 x 20 cm	25	SIL G-25 UV ₂₅₄	809023	ADAMANT UV ₂₅₄	821030	SIL HD UV ₂₅₄	809223

* Further plate sizes available

** Also available as preparative TLC glass plates (PLC) with 0.50, 1.00 and 2.00 mm layer thickness

Silica layers on Polyester sheet

Designation	Thickness of layer	Plate size*	Fluorescent indicator	Plates per pack	REF
SIL G	0.20 mm	2.5 x 7.5 cm	-	200	805902
SIL G	0.20 mm	4 x 8 cm	-	50	805032
SIL G	0.20 mm	5 x 20 cm	-	50	805012
SIL G	0.20 mm	20 x 20 cm	-	25	805013
SIL G	0.20 mm	40 x 20 cm	-	25	805014
SIL G UV ₂₅₄	0.20 mm	2.5 x 7.5 cm	UV ₂₅₄	200	805901
SIL G UV ₂₅₄	0.20 mm	4 x 8 cm	UV ₂₅₄	50	805021
SIL G UV ₂₅₄	0.20 mm	5 x 20 cm	UV ₂₅₄	50	805022
SIL G UV ₂₅₄	0.20 mm	20 x 20 cm	UV ₂₅₄	25	805023
SIL G UV ₂₅₄	0.20 mm	40 x 20 cm	UV ₂₅₄	25	805024
SIL G UV ₂₅₄	0.20 mm	500 x 20 cm	UV ₂₅₄	1 roll	805017

* Further plate sizes available

Silica layers on Aluminum sheet

Designation	Thickness of layer	Plate size*	Fluorescent indicator	Plates per pack	REF
ALUGRAM® Xtra aluminum sheets					
SIL G	0.20 mm	20 x 20 cm	-	25	818233
SIL G UV ₂₅₄	0.20 mm	4 x 8 cm	UV ₂₅₄	50	818331
SIL G UV	0.20 mm	20 x 20 cm	UV ₂₅₄	25	818333
HPTLC ALUGRAM® Xtra aluminum sheets					
Nano-SIL G	0.20 mm	20 x 20 cm	-	25	818241
Nano-SIL G UV ₂₅₄	0.20 mm	20 x 20 cm	UV ₂₅₄	25	818343

* Further plate sizes available

Finisterre™ SPE Column



Feature

- 기기 분석을 위한 시료 전처리용 SPE Column
- 불순물 제거를 통한 시료의 순도 향상 : 장비 및 소모품 수명 연장 및 분석능 향상
- 특화된 Filling PRIM™ 팩킹 기술로 개별 제품의 모니터링 가능
- Pore Size 60 Å의 균일한 실리카 사용으로 최상의 분리 성능 제공

FLO SPE Column



- **Retention Mechanism** : Normal phase
- **Functional Group** : Florisil® (FLO)
- **Base** : Magnesium Silicate
- **Average Particle Size** : 75-100 µm
- **Pore Diameter** : 85 Å
- **Hardware** : Polypropylene
- **Frit** : Polypropylene 20 µm porosity

NH₂ SPE Column



- **Retention Mechanism** : Weak anion exchange with aqueous matrix, normal phase with non-polar organic matrix.
- **Functional Group** : Aminopropyl (NH₂)
- **Endcapped** : no
- **Higher Carbon Load** : 5.0 %
- **Silica Base** : Irregular Shape
- **Average Particle Size** : 50 µm
- **Pore Diameter** : 60 Å
- **Hardware** : Polypropylene
- **Frit** : Polypropylene 20 µm porosity

C18 SPE Column



- **Retention Mechanism** : Reverse phase, one of the most hydrophobic phases
- **Functional Group** : Polymerically bonded octadecyl C18 endcapped. High Capacity C18
- **Endcapped** : yes
- **Higher Carbon Load** : 17.0 %
- **Silica Base** : Irregular Shape
- **Average Particle Size** : 50 µm
- **Pore Diameter** : 60 Å
- **Hardware** : Polypropylene
- **Frit** : Polyethylene 20 µm porosity

Part No	Description	Pk
TR-F034160	Finisterre Flo SPE Column 100 mg/1 ml	100
TR-F034162	Finisterre Flo SPE Column 200 mg/3 ml	50
TR-F034164	Finisterre Flo SPE Column 500 mg/3 ml	50
TR-F034166	Finisterre Flo SPE Column 500 mg/6 ml	30
TR-F034168	Finisterre Flo SPE Column 1000 mg/6 ml	30
TR-F034170	Finisterre Flo SPE Column 1000 mg/12 ml	20

Part No	Description	Pk
TR-F034140	Finisterre SPE Columns NH ₂ 100 mg/1 ml	100
TR-F034142	Finisterre SPE Columns NH ₂ 200 mg/3 ml	50
TR-F034144	Finisterre SPE Columns NH ₂ 500 mg/3 ml	50
TR-F034146	Finisterre SPE Columns NH ₂ 500 mg/6 ml	30
TR-F034148	Finisterre SPE Columns NH ₂ 1000 mg/6 ml	30
TR-F034150	Finisterre SPE Columns NH ₂ 1000 mg/12 ml	20

Part No	Description	Pk
TR-F034000	Finisterre SPE Columns C18/17 % 100 mg/1 ml	100
TR-F034002	Finisterre SPE Columns C18/17 % 200 mg/3 ml	50
TR-F034004	Finisterre SPE Columns C18/17 % 500 mg/3 ml	50
TR-F034006	Finisterre SPE Columns C18/17 % 500 mg/6 ml	30
TR-F034008	Finisterre SPE Columns C18/17 % 1000 mg/6 ml	30
TR-F034010	Finisterre SPE Columns C18/17 % 1000 mg/12 ml	20

QuEChERS



Feature

- 식품, 농산물의 잔류 농약 분석을 위한 빠르고 간편한 전처리 가능
- 300여 종 이상의 잔류 농약을 동시 추출
- Kit 구성으로 수분 흡수 방지
- EN15662, AOAC 2007.01, Mini-multiresidue QuEChERS 등 다양한 QuEChERS Method 충족

50 ml Centrifuge Tube

Part No	Description	Qty	Recommended Application
TR-Q5010	4g MgSO ₄ , 1g NaCl, 1g trisodium citrate dihydrate, 0.5g disodium hydrogencitrate sesquihydrate	50	European EN-15662
TR-Q5040	6g MgSO ₄ , 1.5g NaOAc	50	AOAC 2007.01
TR-Q5020	4g MgSO ₄ , 1g NaCl	50	Mini-Multiresidue (10g sample)
TR-Q5045	6g MgSO ₄ , 1.5g NaCl	50	Mini-Multiresidue (15g sample)
TR-Q5030	6g MgSO ₄ , 1.5g NaCl, 1.5g sodium citrate dibasic, 750mg disodium citrate dibasic sesquihydrate	50	
TR-Q5050	6g MgSO ₄ , 1.5g NaOAc, 750mg disodium citrate sesquihydrate	50	
TR-Q5000	Empty 50ml tube	50	

15 ml Centrifuge Tube

Part No	Description	Qty	Aliquot (ml)	Recommended Application
TR-Q1590	900mg MgSO ₄ 150mg PSA	50	6	European EN-15662
TR-Q1593	900mg MgSO ₄ 150mg PSA 150mg C18	50	6	European EN-15662
TR-Q1591	900mg MgSO ₄ 150mg PSA 15mg GCB	50	6	European EN-15662
TR-Q1592	900mg MgSO ₄ 150mg PSA 45mg GCB	50	6	European EN-15662
TR-Q1510	1200mg MgSO ₄ 400mg PSA	50	8	AOAC 2007.01
TR-Q1515	1200mg MgSO ₄ 400mg PSA 400mg C18	50	8	AOAC 2007.01
TR-Q1516	1200mg MgSO ₄ 400mg PSA 400mg GCB	50	8	AOAC 2007.01
TR-Q1520	1200mg MgSO ₄ 400mg PSA 400mg C18	50	8	AOAC 2007.01
TR-Q1596	900mg MgSO ₄ 150mg C18	50	6	AOAC 2007.01
TR-Q1594	900mg MgSO ₄ 300mg PSA 150mg GCB	50	6	
TR-Q1595	900mg MgSO ₄ 300mg PSA 150mg C18	50	6	
TR-Q1600	750mg MgSO ₄ 250mg PSA 250mg C18	50	6	

2 ml Micro Centrifuge Tube

Part No	Description	Qty	Aliquot (ml)	Recommended Application
TR-Q2015	150mg MgSO ₄ , 25mg PSA	100	1	European EN-15662Mini-Multiresidue
TR-Q2025	150mg MgSO ₄ , 25mg PSA, 25mg C18	100	1	European EN-15662Mini-Multiresidue
TR-Q2035	150mg MgSO ₄ , 25mg PSA, 2.5mg GCB	100	1	European EN-15662Mini-Multiresidue
TR-Q2045	150mg MgSO ₄ , 25mg PSA, 7.5mg GCB	100	1	European EN-15662Mini-Multiresidue
TR-Q2055	150mg MgSO ₄ , 50mg PSA	100	1	AOAC 2007.01
TR-Q2065	150mg MgSO ₄ , 50mg PSA, 50mg C18	100	1	AOAC 2007.01
TR-Q2075	150mg MgSO ₄ , 50mg PSA, 50mg GCB	100	1	AOAC 2007.01
TR-Q2085	150mg MgSO ₄ , 50mg PSA, 50mg C18, 50mg GCB	100	1	AOAC 2007.01
TR-Q2090	150mg MgSO ₄ , 25mg C18	100	1	AOAC 2007.01
TR-Q2000	Empty 2ml Centrifuge Tube	100	1	

PromoChrom's SPE Feature

Easy operation





Lab sample의 preparation procedures과 유사한 auto SPE interface를 사용하여, 사용자가 이질감 없이 사용이 가능합니다. 또한, touch screen을 사용하여 사용자가 쉽게 method를 변경 가능하며 samples, fractions 그리고 columns 모두 쉽게 접근이 가능합니다.

Small footprint

PromoChrom의 SPE는 크기가 작고 외부 컴퓨터가 필요하지 않아 실험실 공간을 크게 차지 하지 않습니다. 휘발성 또는 독성 용매 (ex. Hexane, acetone, petroleum ether)를 사용하는 경우 기기를 fume hood에 넣어 사용하실 수 있습니다.

Compatible with commonly available SPE columns

Column에 특수 캡이나 어댑터가 필요하지 않습니다.
 PromoChrom의 SPE 시스템은 1/3/6 ml 카트리지와 함께 작동합니다.
 Custom adapters도 요청할 경우 사용이 가능합니다.

Increase scalability and features 	Reduce Weight 	Minimize cross-contamination 	Easier Maintenance 
---	---	---	--

Considering all your Solid Phase Extraction needs

- Injection into LC or LC-MS
- Solvent blending for gradient elution (all Offline Auto SPE systems)
- Online derivatization
- Sample bottle rinsing
- SPE column blockage detection and smart handling (all Offline Auto SPE systems)

PromoChrom' SPE System Application

SPE-03	Vivace™ Duo
거의 모든 샘플에서 사용 가능	식품 샘플, 플라즈마, 세럼, 세포용해물 등의 생물학적 시료, 토양 등 환경적 시료

SPE-03 (8-Channel High Volume)



Feature

- Multi Channel SPE System (8 channels)
- Parallel operation
- For high and low volume water, food, fuel & biological samples
- Sample Volume : 0.5 ~ 4,000 ml
- Fluid lines 간소화로 쉽고 깨끗하게 system 작동
- 2 fraction per sample
- 자동 Bottle 세척
- 직관적인 터치스크린 인터페이스
- 2 Waste outlets
- Fume hood에서 사용 가능

Specification

Parameters	SPE-03
Sample capacity	8 samples in parallel
Sample volume	0.5-4,000 ml
SPE column sizes	1/3/6 ml
Solvent capacity	6 solvents
Fractions	2 for each sample
Waste channel	separate outlets for sample and solvent wastes
Flow rate	0.5 ~ 100ml/min
System Control	5" resistive touch screen
Dimensions	34 cm x 34 cm x 45 cm
Weight	13 kg

Ordering Information

Model	Part No.	Description
SPE-03	SPE-03	8-channel SPE-03, 24V power supply, touch screen stylus pen, solvent bottle adapters, default sample tubing and user manual
	MOD-003	Disk kit for 47mm disks, includes disk rack and 8 disk holders
	MOD-004	Sample bottle rack for rinsing up to 250mL bottles. Includes 2 racks with built-in resonators and 8 bottle rinsing adapters
	MOD-004-S	Sample rack for small volume sample loading, includes 2 racks and 8 25mL sample tubes
	MOD-005	Minimal-Teflon option for PFAS applications
	MOD-00P	Volume-Matrix Plus option, includes 3rd multi-channel valve, 2 tilt racks, 8 integrated sample lines for loading/rinsing, 2 sample line hangers and vacuum pump for inline filter drying
	Inline Filters	Contact us for recommended inline filter type

Vivace™ Duo (2-Channel 30-Sample)

New



Feature

- 2-Channel 30-Sample SPE System
- For small sample as food and environment extract, biological fluids
- High efficiency & throughput
- Sample Volume : 0.5 ~ 30ml
- 5인치 터치스크린 인터페이스
- 2 fraction per sample
- 2 waste channel
- 최대 100가지 method
- Sample vial 세척 기능
- Back-Draw 기능으로 회수율 증가

Specification

Parameters	Vivace™ Duo
Sample capacity	30, 2-Channel
Sample volume	0.5 ~ 15ml (sample 1, 2 사용 시 30ml)
SPE column sizes	1/3/6ml
Solvent capacity	6 solvents
Fractions	1 Fraction (Fraction 1, 2 사용 시 2개)
Waste channel	2 waste channels
Flow rate	0.5 ~ 65ml/min
System control	5" resistive touch
Dimensions	35 cm x 43 cm x 35.5 cm
Weight	13kg

Ordering Information

Model	Part No.	Description
Vivace™ Duo	Vivace Duo	Vivace Duo system with one rotating tray, 24V power supply, stylus pen, solvent bottle adapters, waste tubing and user manual
	S04-R-1	Rotating tray for 1ml SPE cartridge size
	S04-R-3	Rotating tray for 3ml SPE cartridge size
	S04-R-6	Rotating tray for 6ml SPE cartridge size
	MOD-005	Minimal-Teflon option for PFAS application

Applications

Petroleum Products

Marine diesel oil, jet fuel

Saturated hydrocarbon, Aromatic hydrocarbon, additives,
Oxidized components, Polar compounds

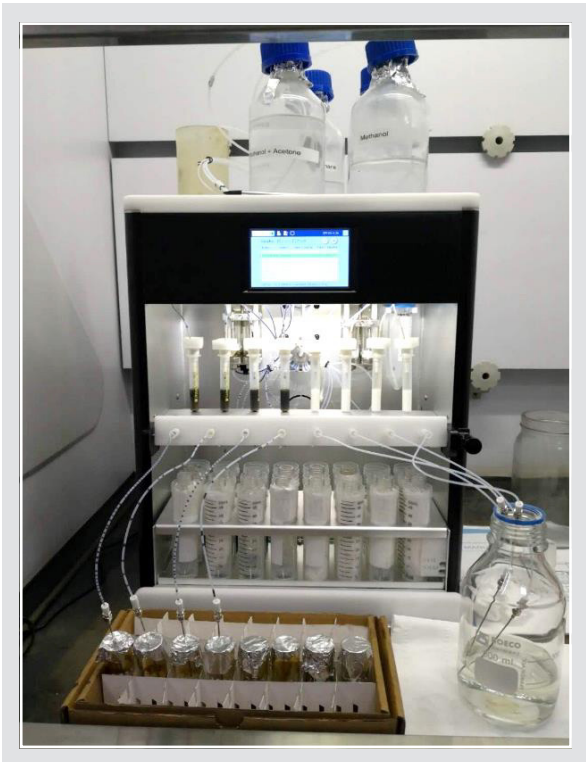

Water

Drinking, Surface, Waste

PFAS, PAHs, PCBs, EPHs, Pesticides, Herbicides, Drugs



Food & Feed

Mycotoxins, Food additives, Pesticides, Drugs



Soil, Solids & Biosolids

Extract clean up of PFAS, EPHs, PPCPs

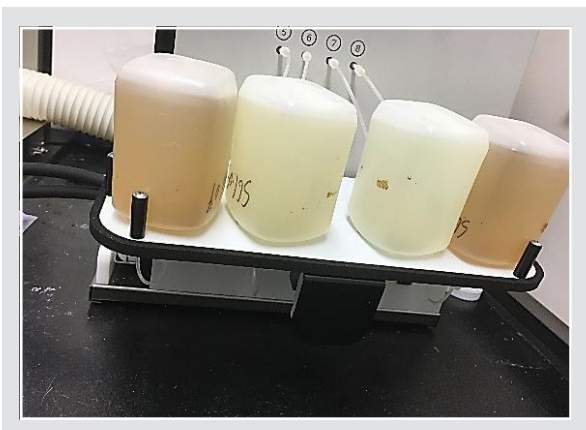

Biological Samples

Protein, Urine & Blood

Antibodies, Antigens, Metabolites, Drugs, Hormones





Sample Preparation



Syringe Filter Membrane Filter	80
Filter Funnel Solvac Filter Holder	82
Vacuum Pump	83
Vial & Cap	84
Pipette (Manual / Electronic)	88
Pipette Aid Bottle Top Dispenser	91
Bottle Cap	92
Solvent Filter	93
Safety Cap	94
Safety Waste Cap	96
Exhaust Filter	99
Safety Funnel	100
Water Purification System	102

PALL Syringe Filter



Feature

- 비멸균 : 분석분야 (화학, 약학, 제약 QC 분야)
- 멸균 : 바이오 분야 (생명공학, 제약 R&D 분야)
- 시료의 화학적 특성에 따른 필터 재질 선택
- 일반 실험에서 요구되는 Pore Size : 0.2, 0.45 μm

재질	특징
PES	빠른 Flow rate 및 많은 처리량과 샘플과 단백질 결합이 적어 샘플 손실이 낮은 입자 여과, Buffer, 조직 배양액에 적용
wwPTFE	모든 용매와 HPLC & UHPLC 이동상에 사용가능, GHP보다 광범위한 화학적 호환성 및 안정성, 높은 Flow rate, 낮은 API binding, 10배 낮은 Extractables 및 컬럼 수명 최대 52배까지 연장
PVDF	화학 저항성이 좋은 재질, 대부분 HPLC 시료여과 및 Low 단백질 흡착률로 일반적인 생물학 샘플 여과에 적용, Acetone, DMF, DMSO, 6N이상의 염기에는 적합하지 않음
PTFE	거의 모든 유기용매에 사용가능, 크로마토그램 상 Spurious Peaks을 방지, 가스, 유기용매 여과에 적용
Nylon	가장 많이 사용되는 멤브레인, 대부분의 시료에서 빠른 Flow rate, 강산이나 강염기에는 사용 불가능, 일반실험 및 대부분의 HPLC 시료 여과

* Hydrophilic Polyethersulfone (PES)

* Water wetttable hydrophilic polytetrafluoroethylene (wwPTFE) : Hydrophilic Polypropylene (GHP) 대체 재질

Acrodisc Syringe Filter (Premium)

멸균 제품						
재질	구분	Pore Size	Dia	포장단위	Part No.	
		(μm)	(mm)			
PES	수용성	0.2	13	75/pk	4602	
			25	50/pk	4612	
			32		4652	
		0.45	13	75/pk	4604	
			25	50/pk	4614	
			32		4654	
비멸균 제품						
재질	구분	Pore Size	Dia	포장단위	Part No.	
		(μm)	(mm)			
wwPTFE	수/지용성 겸용	0.2	13	100/pk	2400	
			25	50/pk	4927	
			13	100/pk	2402	
		0.45	25	50/pk	4914	
			0.2	13	100/pk	4450
				25	50/pk	4406
PVDF	수용성	0.45		13	100/pk	4452
			25	50/pk	4408	
			0.2	13	100/pk	4423
		25		50/pk	4225	
		0.45		13	100/pk	4422
			25	50/pk	4219	
PTFE	지용성		0.2	13	100/pk	4427
		25		50/pk	4436	
		0.45		13	100/pk	4426
			25	50/pk	4438	
			0.2	13	100/pk	4427
		25		50/pk	4436	
0.45	13	100/pk		4426		
	25	50/pk	4438			

Sample Preparation Syringe Filter | Membrane Filter



Made in USA

Sample Preparation

Value-Prep Syringe Filter (Economic)

재질	구분	Pore Size (μm)	Dia (mm)	포장단위	Part No.
wwPTFE	수/지용성 겸용	0.2	13	100/pk	6614567-1
			25		6604652-1
		0.45	13		6614563-1
			25		6604566-1
PVDF	수용성	0.2	13	100/pk	6054510-1
			25		6054520-1
		0.45	13		6054511-1
			25		6054500-1
PTFE	지용성	0.2	13	100/pk	6054523-1
			25		6054521-1
		0.45	13		6054524-1
			25		6054501-1
Nylon	수용성	0.2	13	100/pk	6054540-1
			25		6054522-1
		0.45	13		6054541-1
			25		6054502-1

Membrane Filter



Feature

- HPLC 이동상의 불순물 및 가스 제거
- 용매 조건을 충족하는 다양한 재질 선택 가능
- 빠른 필터링 속도로 생산성 향상
- wwPTFE 재질 : 수/지용성 겸용으로 HPLC 전처리에 최적
- Nylon 재질 : Esters, Alchols, Water 등에 사용이 최적
- PTFE 재질 : 강한 유기용매에 사용 가능

재질	구분	Pore Size (μm)	Dia (mm)	포장단위	Part No.
wwPTFE	수/지용성	0.2	25	50/pk	60538
			47		60539
			50		60542
		0.45	25		60547
			47		60548
			50		60550
			90		60551
Nylon	수용성	0.2	25	100/pk	66601
			47		66602
		0.45	25		66607
			47		66608
PTFE	지용성	0.2	25	100/pk	66142
			47		66143
		0.45	25		66148
			47		66149

Sample Preparation Filter Funnel | Solvac Filter Holder



Made in USA

47 mm Filter Funnels, Glass



Feature

- HPLC 이동상 진공 여과시 사용
- 내화학성이 강한 100% Borosilicate Glass
- 1L의 용량을 한번에 여과할 수 있음
- 역류 방지 디자인

Part No.	Description	Effective Filtration Area	Filter Size	Qty
4011	Glass filter funnel with No. 8 stopper support base (300 ml funnel, no flask)	9.6 cm ²	47 mm	1 ea
4012	Glass filter funnel with sidearm support assembly and flask (1 L funnel with 4 L flask)	9.6 cm ²	47 mm	1 ea
4013	Glass filter funnel with sidearm support assembly and flask (300 ml funnel with 1 L flask)	9.6 cm ²	47 mm	1 ea

Solvac[®] Filter Holder



Feature

- 대부분의 HPLC 용매병, 플라스크에 적합
- 간편하게 이동상 용매를 필터링
- HPLC 용매병에서 이동상을 정확히 Transfer 함
- 내구성이 높아 파손될 가능성이 낮음
- 특허를 받은 마그네틱 씰은 용매의 leak 방지
- 재사용이 가능하며 화학적 내구성이 강한 PP재질로 구성됨
- 47mm membrane filter 사용 가능

Part No.	Description	Qty
4020	Solvac holder with 61 cm (2 ft.) feedline tubing, thumb clamp, sinker, vacuum port adapter, 2 membrane seal gaskets, and 2 seal gaskets	1 SET

Instructions for use



1. 깨끗하고 건조된 필터 지지대 위에 멤브레인을 놓습니다



2. 상단 하우징에 feedline tubing을 부착 후 멤브레인이 단단히 밀봉 되도록 상단 하우징을 하단 하우징 위에 놓으십시오



3. Vacuum source에서 Vacuum port Adapter까지 진공 튜빙을 연결하십시오



4. 여과 할 용매에 feedline tubing을 넣습니다



5. 필터를 통해 용매가 통과 되도록 진공을 걸어줍니다

Oil-Free Piston Vacuum Pump



V300

Feature

- 오일이 필요 없는 피스톤 펌프로 유지 보수가 간편
- 실린더의 축을 중심으로 피스톤 왕복 운동
- 비 부식성 물질에 적합
- 가스 용매 사용 가능
- 진공 생성 및 압력 공급이 가능하여 다양한 실험환경에 적합
- 낮은 소음 : 50~60 dB



V400

Application

- 액체 여과 및 진공 건조
- 진공 추출 및 압력 공급
- 미생물 검출 및 부유 물질 측정

Specification

Model	V300	V400	
Mains Requirements	220-240V / 50Hz	220-240V / 50Hz	
Power (W)	80	80	
Current (A)	0.3	0.4	
Ultimate Vacuum (mbar)	150	150	
Flow Rate	1000 mbar	17 L/min	34 L/min
	880 mbar	14 L/min	31 L/min
	750 mbar	12 L/min	29 L/min
	600 mbar	9.5 L/min	23 L/min
	480 mbar	7 L/min	19 L/min
	350 mbar	4.5 L/min	13 L/min
	210 mbar	1.5 L/min	4 L/min
Outlet (mm)	8	10	
Motor Speed (rpm)	1450	1450	
Weight (kg)	4.1	5.2	
Noise Level (dB)	50	60	

Screw / Crimp / Snap Vial 비교

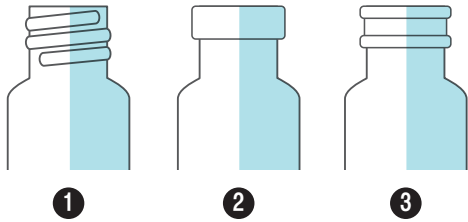

- ① **Screw cap vial** : 기타 장비 없이 쉽게 돌려 열고 닫을 수 있음
시료의 증발율이 낮음
- ② **Crimp cap vial** : 알루미늄 재질의 Cap 사용하여 재사용 불가능
탈/장착시 별도의 도구 필요 (Crimper & Decapper)
- ③ **Snap cap vial** : PP재질의 Cap을 사용하여 손쉽게 탈부착 가능
Screw와 Crimp cap의 중간 단계의 특징

Rainbow Vial Figure & Specific

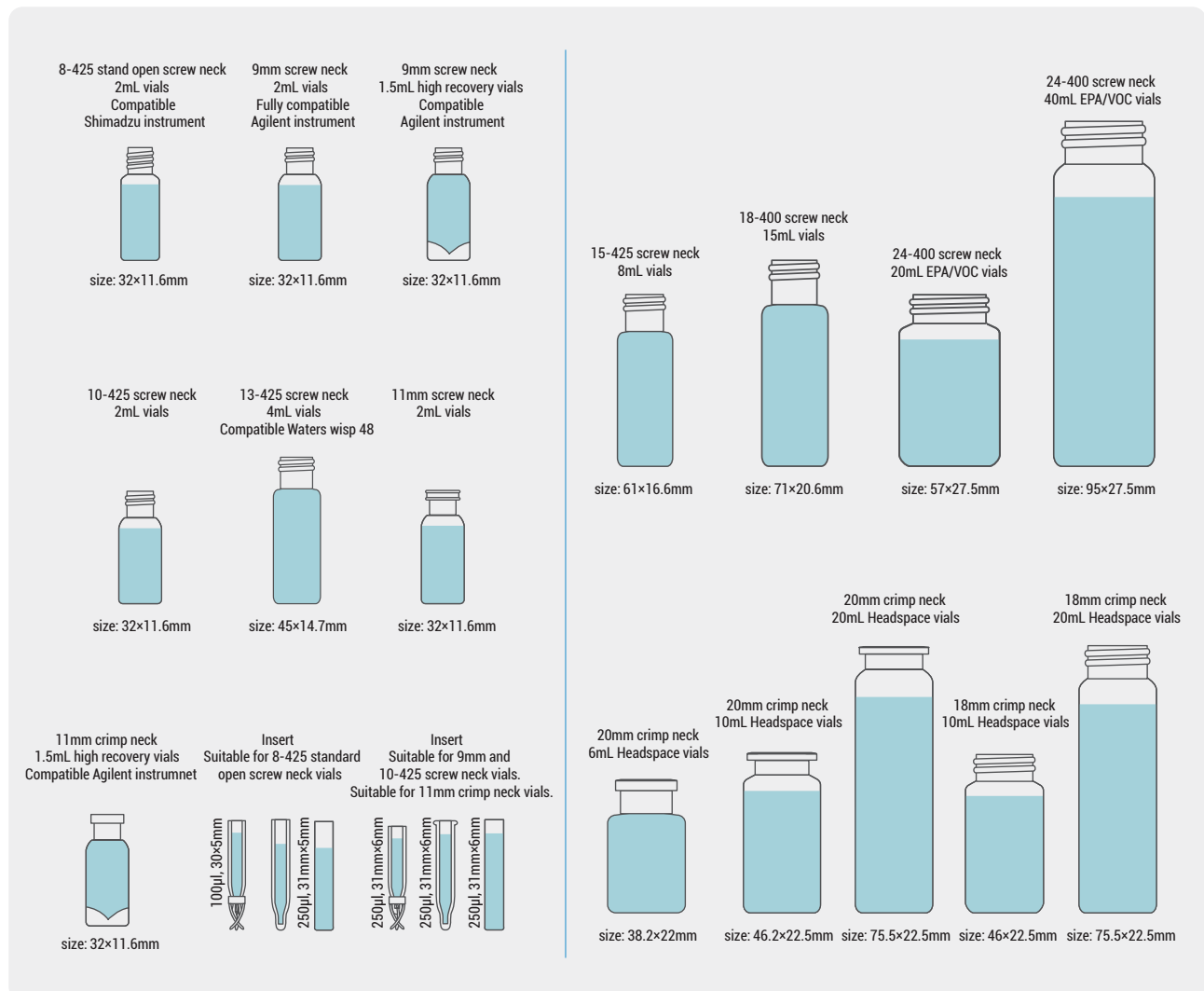

Screw / Crimp / Snap Vial & Cap

Feature

- Agilent, Thermo Scientific, Waters, Varian 등 주요 HPLC, GC기기에 호환 가능
- 시료의 손실과 오염을 줄여주고 정확한 분석 결과 제공
- 전 제품을 무균실에서 포장하므로 안전한 실험 가능
- 인쇄 공정에 Pb, Cr 등의 중금속이 아닌 세라믹 인쇄 공정을 사용하여 유럽의 RoHs 규격 충족

2 ml Screw Vial & Cap



Part No.	Description	Qty
SVL020-1C02	9 mm Screw Vial, 32x11.6 mm, Clear glass	100/pk
SVL020-2C02	9 mm Screw Vial, 32x11.6 mm, Clear glass, Write on	100/pk
SVL020-3C03	9 mm Screw Vial, 32x11.6 mm, Amber glass	100/pk
SVL020-4C02	9 mm Screw Vial, 32x11.6 mm, Amber glass, Write on	100/pk
SDB040-2103	9 mm Screw, PP cap, Blue, White silicone/Red PTFE	100/pk
SDB040-2201	9 mm Screw, PP cap, Blue, White silicone/Red PTFE, Pre-slit	100/pk

2 ml Crimp Vial & Cap



Part No.	Description	Qty
CVL020-1C01	11 mm Crimp Vial, 32x11.6 mm, Clear glass	100/pk
CVL020-2C01	11 mm Crimp Vial, 32x11.6 mm, Clear glass, Write on	100/pk
CVL020-3C01	11 mm Crimp Vial, 32x11.6 mm, Amber glass	100/pk
CVL020-4C01	11 mm Crimp Vial, 32x11.6 mm, Amber glass, Write on	100/pk
CDC040-1103	11 mm Crimp , Aluminum cap, Blue, Centre hole, Natural Rubber Redorange/Butyl Red/TEF transparent, 0.040" thick	100/pk
CDC040-1101	11 mm Crimp , Aluminum cap, Green, Centre hole, Natural Rubber Redorange/ Butyl Red/TEF transparent, 0.040" thick	100/pk
CDC040-2101	11 mm Crimp , Aluminum cap, Red, Centre hole, Natural Rubber Redorange/Butyl Red/TEF transparent, 0.040" thick	100/pk
CDC040-8101	11 mm Crimp , Aluminum cap, black, Centre hole, White silicone/Red PTFE, 0.040" thick	100/pk

2 ml Snap Vial & Cap



Part No.	Description	Qty
NVL020-1A01	11 mm Snap Vial, 32x11.6mm, Clear glass	100/pk
NVL020-2A02	11 mm Snap Vial, 32x11.6mm, Clear glass, Write on	100/pk
NVL020-3B01	11 mm Snap Vial, 32x11.6mm, Amber glass	100/pk
NVL020-4B02	11 mm Snap Vial, 32x11.6mm, Amber glass, Write on	100/pk
NDC000-5101	11 mm Snap, PE cap, transparent, Centre hole, Molded septum	100/pk
NDC000-6102	11 mm Snap, PE cap, transparent, Centre hole, White silicone/Red PTFE	100/pk
NDC000-5103	11 mm Snap, PE cap, transparent, Centre hole, Red PTFE/White silicone/Red PTFE	100/pk
NDC000-5201	11 mm Snap, PE cap, transparent, Centre hole, White silicone/Blue PTFE, Pre-slit	100/pk

Headspace Vial



Feature

- Sealing 효과를 위해 Vial과 더 큰 접촉 면적을 갖는 Septa로 제작
- Rounded bottom형은 더 높은 압력에서도 사용할 수 있음
- 균일한 두께 및 우수한 내열 충격 저항성

Part No.	Description	Qty
HSS200-2A02	Clear glass 20 ml Crimp headspace vial, Rounded-Flat Bottom, 20mm Beveled Edge	100/pk
HSS200-2A01	Clear glass 20 ml Crimp headspace vial, Flat Bottom, 20mm Beveled Edge	100/pk
HSS100-2A02	Clear glass 10 ml Crimp headspace vial, Rounded-Flat Bottom, 20mm Beveled Edge	100/pk
HSS100-2A01	Clear glass 10 ml Crimp headspace vial, Flat Bottom, 20mm Beveled Edge	100/pk
HDF125-1101	20mm Open Top Aluminum Crimp Cap (10mm hole) sith 20mm White PTFE/White Silicone Septa 3mm Thick	100/pk
CRP20	Manual Crimper for 20mm flip off seals, stainless steel	ea
DCRP20	Manual Decapper for 20mm Aluminum Crimp caps, stainless steel	ea

Crimper and Decapper



Feature

- Crimp Vial에 Cap을 탈부착시 사용
- 손잡이 부분은 코팅되어 부식을 방지
- 특수 합금 소재로 헤드가 제작되어 긴 수명을 보장
- 손잡이의 Screw nut를 조정하여 sealing의 효과를 높임
- Decapper는 사용이 쉽고 유리부품이 파손되는 것을 막아줌

Part No.	Type	Description	Qty
ETCCPR-0004	Crimper	Crimper for 8mm Aluminum caps	ea
ETCCPR-0001	Crimper	Crimper for 11mm Aluminum caps	ea
ETCCPR-0002	Crimper	Crimper for 13mm Aluminum caps	ea
ETCCPR-0003	Crimper	Crimper for 20mm Aluminum caps	ea
ETCDPR-0004	Decapper	Decapper for 8mm Aluminum caps	ea
ETCDPR-0001	Decapper	Decapper for 11mm Aluminum caps	ea
ETCDPR-0002	Decapper	Decapper for 13mm Aluminum caps	ea
ETCDPR-0003	Decapper	Decapper for 20mm Aluminum caps	ea

Insert Vial



Feature

- 소량의 시료를 사용하거나, 샘플의 회수율을 높이기 위해 일반 Vial에 넣어 사용

Part No.	Description	Qty
INF000-7002	250 µl, 5x31mm Insert Clear Glass Flat Base, USP1	100/pk
INF000-7001	300 µl, 6x31mm Insert Clear Glass Flat Base, USP1	100/pk
INI000-7002	100 µl, 5x29mm Insert Clear Glass Conical Base with Polyspring, USP1	100/pk
INI000-7001	200 µl, 6x29mm Insert Clear Glass Conical Base with Polyspring, USP1	100/pk
INC000-7002	150 µl, 5x31mm Insert Clear Glass Conical Base, USP1	100/pk
INC000-7001	250 µl, 6x31mm Insert Clear Glass Conical Base, USP1	100/pk

TOC Vial



Feature

- TOC관리 기준 (SOP)에 따라 선택 가능한 Vial
- 10ppb & 20ppb기준의 2종류 Vial 공급
- Certification 발급 : 10ppb이하 제조 증명

Part No.	Description	Qty
TOCV20	20 ml 57x27.5 mm Clear Glass TOC Vial, PP Screw Cap with 22 mm Natural PTFE/White Silicone 3.0 mm thick Septa	100/pk
TOCAV20	20 ml 57x27.5 mm Amber Glass TOC Vial, PP Screw Cap with 22 mm Natural PTFE/White Silicone 3.0 mm thick Septa	100/pk
TOCV40	40 ml 95x27.5 mm Clear Glass TOC Vial, PP Screw Cap with 22 mm Natural PTFE/White Silicone 3.0 mm thick Septa	100/pk
TOCAV40	40 ml 95x27.5 mm Amber Glass TOC Vial, PP Screw Cap with 22 mm Natural PTFE/White Silicone 3.0 mm thick Septa	100/pk

TOC Vial Certificate

Product Certificate

CATALOG NUMBER C0000334 LOT NUMBER 000G0121

GC/MS Agilent 7890/5975

TOC Analyzer EST_Vocarb.3000 PROCESS DATE 1/21/19

PARAMETERS

DESCRIPTION 40mL 27.5x95mm Clear Glass EPA/TOC Vial 24-400 White Open Top PP Screw Cap with 22mm Natural PTFE/White Silicone 3.0mm thick Septa (EPA Quality)

This is to certify that the item(s) as stated above have been processed on Agilent 7890/5975 and EST Vocarb 3000.

ANALYSIS

Total vial contribution after blank subtraction is as listed:

ANALYTE	SPECIFICATION	RESULT
Total Organic Carbon	<10ug/L	<10ug/L

ALWSCI Technologies certifies that the item(s) in above referenced shipment were processed, tested, and meets the specifications above for this product.

Approved By:  Lisa Ke 1/21/19
Quality Assurance

Compatibility with Other Manufacturers

Model	Type	Maker			
		Rainbow	Waters	Agilent	Thermo
2 ml Screw Vial	9 mm Screw Vial, 32x11.6 mm, Clear glass	SVL020-1C02	186000273	5182-0714	CHSV9-10
	9 mm Screw Vial, 32x11.6 mm, Clear glass, Write on	SVL020-2C02	186000272C	5182-0715	CHSV9-10P
	9 mm Screw Vial, 32x11.6 mm, Amber glass	SVL020-3C03	186000848	5188-6535	CHSV9-20
	9 mm Screw Vial, 32x11.6 mm, Amber glass, Write on	SVL020-4C02	186000847C	5182-0716	CHSV9-20P
2 ml Screw Cap	9 mm Screw, PP cap, Blue, White silicone/Red PTFE	SDB040-2103	186000274	5182-0717	CHSC9-30
	9 mm Screw, PP cap, Blue, White silicone/Red PTFE, Pre-slit	SDB040-2201	186000305	5183-2076	CHSC9-40

Accupet EVO Pipette (Single / Multi)



Feature

- 우수한 품질의 경제적인 피펫
- 적은 힘으로 Plunger를 부드럽게 누를 수 있음
- 높은 정확도와 정밀성, 일관된 결과 제공
- 잠금 장치 기능
- 부식 및 물리적 충격에 강함
- Full 오토클레이브 가능 (121 °C, 20분)
- 내구성이 뛰어난 PVDF재질의 Tip cone
- 일반 Tip과 호환 가능
- 1채널/ 8채널/ 12채널

Accupet EVO Pipette (Single Channel)

Single channel Part No.	Description	Volume Range (µl)
AE-2.5	Accupet EVO Single Channel Adjustable vol. pipette	0.1 to 2.5
AE-10	Accupet EVO Single Channel Adjustable vol. pipette	0.5 to 10
AE-20	Accupet EVO Single Channel Adjustable vol. pipette	2 to 20
AE-50	Accupet EVO Single Channel Adjustable vol. pipette	5 to 50
AE-100	Accupet EVO Single Channel Adjustable vol. pipette	10 to 100
AE-200	Accupet EVO Single Channel Adjustable vol. pipette	20 to 200
AE-1000	Accupet EVO Single Channel Adjustable vol. pipette	100 to 1000
AE-5000	Accupet EVO Single Channel Adjustable vol. pipette	500 to 5000
AE-10000	Accupet EVO Single Channel Adjustable vol. pipette	1000 to 10000

Accupet EVO Pipette (Multi Channel)

8-Channel Part No.	12-Channel Part No.	Description	Volume Range (µl)
AE8-10	AE12-10	Accupet EVO Multi Channel Adjustable vol. Pipette	0.5 to 10
AE8-20	AE12-20	Accupet EVO Multi Channel Adjustable vol. Pipette	2 to 20
AE8-50	AE12-50	Accupet EVO Multi Channel Adjustable vol. Pipette	5 to 50
AE8-100	AE12-100	Accupet EVO Multi Channel Adjustable vol. Pipette	10 to 100
AE8-200	AE12-200	Accupet EVO Multi Channel Adjustable vol. Pipette	20 to 200
AE8-300	AE12-300	Accupet EVO Multi Channel Adjustable vol. Pipette	30 to 300

BenchMate® L Pipette (Single / Multi)



Feature

- 편안한 착용감, 피로 감소, 정확하고 정밀한 피펫팅
- 잠금 장치 기능
- Full 오토클레이브 가능 (121°C, 20분)
- 미세 볼륨 (2~10 µl 볼륨)에 대한 향상된 정확도 제공
- 부식 및 물리적 충격에 강함
- 세라믹 Plunger는 내구성과 UV 저항을 향상시킴
- 일반 Tip과 호환 가능
- 1채널/ 8채널/ 12채널

BenchMate® L Pipette (Single Channel)

Single channel Part No.	Volume Range (µl)	Increments (µl)	Volume (µl)	Accuracy (systematic error) AC (%)	Precision (random error) CV (%)
OBL-2	0.1 to 2	0.002	0.2	±12.0	≤6.0
			1	±5.0	≤2.5
			2	±3.0	≤1.0
OBL-10	1.5 to 10	0.001	1	±4.0	≤3.0
			5	±1.0	≤1.0
			10	±1.0	≤0.5
OBL-20	2 to 20	0.02	2	±5.0	≤3.0
			10	±1.0	≤1.0
			20	±1.0	≤0.4
OBL-100	10 to 100	0.1	10	±2.0	≤1.0
			50	±1.0	≤0.3
			100	±0.8	≤0.3
OBL-200	20 to 200	0.2	20	±1.0	≤0.5
			100	±0.8	≤0.3
			200	±0.8	≤0.2
OBL-1000	100 to 1000	1	100	±1.0	≤0.5
			500	±0.8	≤0.3
			1000	±0.7	≤0.2

BenchMate® Pipette (Multi Channel)

8-Channel Part No.	12-Channel Part No.	Volume Range (µl)	Increments (µl)	Volume (µl)	Accuracy (systematic error) AC (%)	Precision (random error) CV (%)
OB8-10	OB12-10	0.5 to 10	0.01	1	±8.0	≤5.0
				5	±4.0	≤2.0
				10	±2.0	≤1.0
OB8-100	OB12-100	5 to 100	0.1	10	±3.0	≤2.0
				50	±1.0	≤0.8
				100	±0.8	≤0.3
OB8-200	OB12-200	20 to 200	0.2	20	±3.0	≤0.6
				100	±1.0	≤0.4
				200	±0.9	≤0.3
OB8-300	OB12-300	30 to 300	1	30	±3.0	≤1.0
				150	±1.0	≤0.5
				300	±0.6	≤0.3

BenchMate® E Electronic Pipette (Single / Multi)



Feature

- 경량 피펫으로 양손 모두 사용 가능
- 정확하고 정밀한 피펫팅
- 고성능 Stepping motor 사용
- 셋팅값 암호 설정으로 일관된 사용 가능
- 하부 분리 기능으로 오토클레이브 가능 (121℃, 20분)
- 충전상태에서 피펫 사용 가능 (미사용시 2시간 내 충전)
- 최대 3개 프로그램 저장 및 사용
- 1채널/ 8채널/ 12채널

Popular Pipetting Mode



BenchMate® E Electronic Pipette (Single Channel)

Single Channel Part No.	Volume Range (μl)	Increments (μl)	Volume (μl)	Accuracy (systematic error) AC (%)	Precision (random error) CV (%)
OBE-10	0.5 to 10 ●	0.01	1	±2.5	≤1.8
			5	±2	≤1
			10	±1	≤0.6
OBE-100	5 to 100 ●	0.1	10	±3	≤1
			50	±1	≤0.5
			100	±0.8	≤0.2
OBE-200	10 to 200 ●	0.1	20	±2.5	≤0.7
			100	±0.7	≤0.3
			200	±0.6	≤0.2
OBE-1000	50 to 1000 ●	1	100	±3	≤0.6
			500	±1	≤0.4
			1000	±0.6	≤0.2
OBE-5000	250 to 5000 ●	5	500	±2.4	≤0.6
			2500	±1.2	≤0.25
			5000	±0.6	≤0.15

BenchMate® E Electronic Pipette (Multi Channel)

8-Channel Part No.	12-Channel Part No.	Volume Range (μl)	Increments (μl)	Volume (μl)	Accuracy (systematic error) AC (%)	Precision (random error) CV (%)
OBE8-10	OBE12-10	0.5 to 10 ○	0.01	1	±8	≤5
				5	±4	≤2
				10	±2	≤1
OBE8-20	OBE12-20	2 to 20 ●	0.01	2	±7	≤3
				10	±3	≤2
				20	±2	≤1.6
OBE8-100	OBE12-100	5 to 100 ●	0.1	10	±3	≤2
				50	±1	≤0.8
				100	±0.8	≤0.3
OBE8-200	OBE12-200	10 to 200 ●	0.1	20	±5	≤1.4
				100	±1	≤0.4
				200	±0.7	≤0.25
OBE8-300	OBE12-300	15 to 300 ●	0.1	30	±3	≤1
				150	±1	≤0.5
				300	±0.6	≤0.3

AccuHelp Pipette Controller



Feature

- 저소음 전동 피펫 컨트롤러
- 25 ml 샘플 용량을 4초 이내 흡입 가능
- 인체공학적 설계로 편리하며 가벼움
- Pipette Cone은 오토클레이브 가능
- 안전 밸브 및 소수성 필터는 Fluid에 대한 이중보호 가능
- 세가지 속도 모드 : 고속, 저속, 중력 모드
- 컨트롤 방식은 손의 압력으로 미세 조절 가능
- 친환경 NiMH 배터리

Specification

Power	2 x 1.2 V / 1000 mAh rechargeable NiMH batteries
Battery usage Duration	Eight mAh hours continuous use
Battery Charging Duration	2 mAh 3 mAh hours to charge fully
Volumetric Range	Plastic or Glass pipette from 0.1 ml up to 200 ml
Safety System	Replaceable hydrophobic 0.45 um PTFE filter
Safety Feature	Safety check valve

AccuTop Bottle Top Dispenser



Feature

- 높은 정확성과 정밀성
- ISO 17025 공인 교정 시설에서 교정 완료
- 재순환밸브가 있어 액체 폐기물을 최소화 함
- 최고의 원자재 사용으로 내구성, 안정성 우수
- 긴 수명을 위한 Spring-less Valve
- 360도 디스펜싱 가능
- 볼륨 잠금장치 및 재보정이 쉬움

Specification

Part No.	Volume Range (ml)	Increment ml	Inaccuracy (+/-) %	Inaccuracy (+/-) ml	Imprecision (+/-) %	Imprecision (+/-) ml	Recirculation
AD-2.5	0.25 to 2.5	0.05	0.6	0.015	0.2	0.005	NO
AD-30	2.5 to 30	0.5	0.5	0.15	0.2	0.06	NO
AD-60	5 to 60	1	0.5	0.3	0.2	0.12	NO
ADR-05	0.5 to 5	0.1	0.5	0.025	0.2	0.01	YES
ADR-10	1 to 10	0.2	0.5	0.05	0.2	0.02	YES
ADR-25	2.5 to 25	0.5	0.6	0.015	0.2	0.005	YES
ADR-30	2.5 to 30	0.5	0.5	0.15	0.2	0.06	YES
ADR-60	5 to 60	1	0.5	0.3	0.2	0.12	YES

Bottle Cap

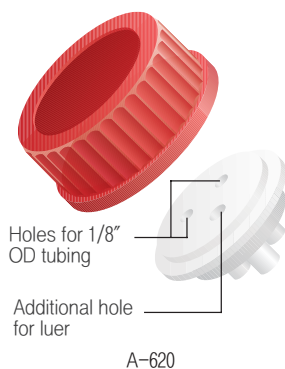

Feature

- Solvent Bottle로 가장 많이 사용되는 GL-45 / GL-38에 맞는 Bottle Cap
- 별도의 피팅 필요없이 튜빙을 직접 통과시켜 사용할 수 있음
- 3개의 Hole이 있으며, 2개의 Hole에는 튜빙을 직접 통과시켜 사용
- Luer Taper 형태를 지닌 3번째 Hole은 Plug나 Filter Plug를 꽂는 등 다양한 용도로 사용

Part No.	Description	Qty
A-620	For GL-45, 1/8" OD Tubing, Red	ea
A-630	For GL-45, 1/16" OD Tubing, Red	ea
A-610	For GL-45, 3/16" OD Tubing, Red	ea
A-622	For GL-38, 1/8" OD Tubing, Black	ea

Bottle Cap Plug

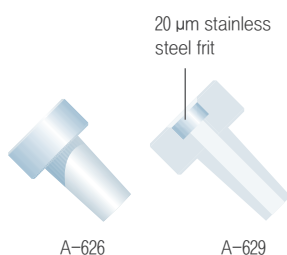

Feature

- Bottle Cap에서 Tubing Hole 또는 Luer Hole를 막는 용도로 사용
- 모든 Plug의 재질은 UHMWPE

Part No.	Type	Description	Qty
A-626	Bottle Cap Plug	For Luer hole	ea
A-627	Filter Bottle Cap Plug	For Luer hole, with 20 μm SST Frit	ea
A-628	Bottle Cap Plug	For 1/16", 1/8" or 3/16" hole	ea
A-629	Filter Bottle Cap Plug	For 1/16", 1/8" or 3/16" hole, with 20 μm SST Frit	ea

Bottle Cap (Teflon)



F745-04



F746-12

Feature

- PTFE재질의 Bottle Cap
- Bottle Cap Thread : GL-45
- 내산성, 내화학성 우수
- 잠금 밸브가 있는 Stopcock Type 선택 가능
- ¼-28 Thread의 피팅을 사용하여 1/16" OD, 1/8" OD Tubing 연결
- 사용 가능 온도 : ~200°C
- Maker : BOLA (Made in Germany)

Part No.	Number of Stopcocks	For tubing ID x OD (mm)	Bore dia (mm)	Qty
F745-02	without	0.8 x 1.6	0.8	ea
F745-04	without	1.6 x 3.2	1.6	ea
F745-10	without	0.8 x 1.6	0.8	ea
F745-12	without	1.6 x 3.2	1.6	ea
F746-02	2	0.8 x 1.6	-	ea
F746-04	2	1.6 x 3.2	-	ea
F746-10	3	0.8 x 1.6	-	ea
F746-12	3	1.6 x 3.2	-	ea

Solvent Filter (General Type)

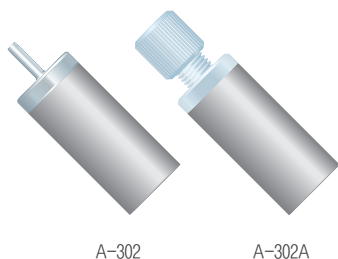

Feature

- 이동상 (용매)내에 불순물이나 공기 방울이 시스템 내로 유입되는 것을 방지
- 펌프의 손상 보호 기능
- 직접 튜빙을 Stem에 연결 할 수 있는 가장 보편적인 타입
- 10, 20 μm Pore size 선택 가능

Part No.	Description	Max. Flow rate	Qty
A-302	10 μm SST Filter, For 1/16" ID Tubing	40 ml/min	ea
A-302A	10 μm SST Filter with Fitting, For 1/8" OD Tubing	40 ml/min	ea
A-310	10 μm SST Filter, For 1/8" ID Tubing	40 ml/min	ea
A-225	20 μm SST Filter, For 1/16" ID Tubing	100 ml/min	ea
A-225A	20 μm SST Filter with Fitting, For 1/8" OD Tubing	100 ml/min	ea

Solvent Filter (Replaceable Type)

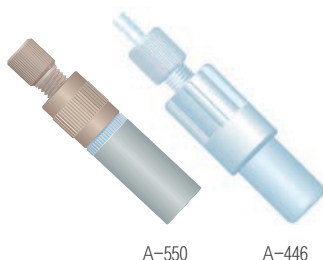

Feature

- Stainless Steel Filter Cup을 교환 할 수 있는 타입
- 튜빙을 연결 할 수 있는 Fitting 포함
- 경제적인 UHMWPE 재질 선택 가능

Part No.	Description	Max. Flow rate	Qty
A-550	10 μm SST Filter Assembly, For 1/8" OD Tubing	40 ml/min	ea
A-551	2 μm SST Filter Assembly, For 1/8" OD Tubing	10 ml/min	ea
A-520x	10 μm SST Replacement Solvent Filter Cup	40 ml/min	10/pk
A-522x	2 μm SST Replacement Solvent Filter Cup	10 ml/min	10/pk
A-446	10 μm UHMWPE Filter Assembly, For 1/8" OD Tubing	5 ml/min	ea
A-427	10 μm UHMWPE Replacement Solvent Filter Cup	5 ml/min	5/pk

Solvent Filter (Bottom-of-the-Bottle)



Feature

- 이동상 바닥의 용매까지 흡입 가능한 타입
- 2개의 튜빙을 연결하여 한쪽 라인은 용매를 빨아들이며, 다른 라인은 헬륨 퍼징 (Helium Sparging) 가능
- 100% PEEK 재질

Part No.	Description	Max. Flow rate	Qty
A-435	2 μm PEEK Filter, For 1/8" OD Tubing	10 ml/min	ea
A-440	10 μm PEEK Filter, For 1/8" OD Tubing	40 ml/min	ea

Technology of SafetyCap 2.0



Feature

- 유기용매에 의한 실험실 환경개선 및 실험자 보호
- 통합형 Air Valve를 통하여 공기는 유입 시키고 증기 및 유해 가스의 배출은 차단하여 Solvent의 소모를 30%까지 감소시킴 (6개월 수명)
- PTFE filter를 통한 공기유입으로 이동상의 오염을 방지
- Solvent 휘발을 막아 이동상 비율을 유지하여 peak 머무름 시간의 재현성 확보
- 사용자 조건에 따른 다양한 Thread 선택 가능
- 다양한 Adapter로 여러 개의 Tubing 라인 장착
- 편리한 Bottle 교체 방식

Safety Cap Part

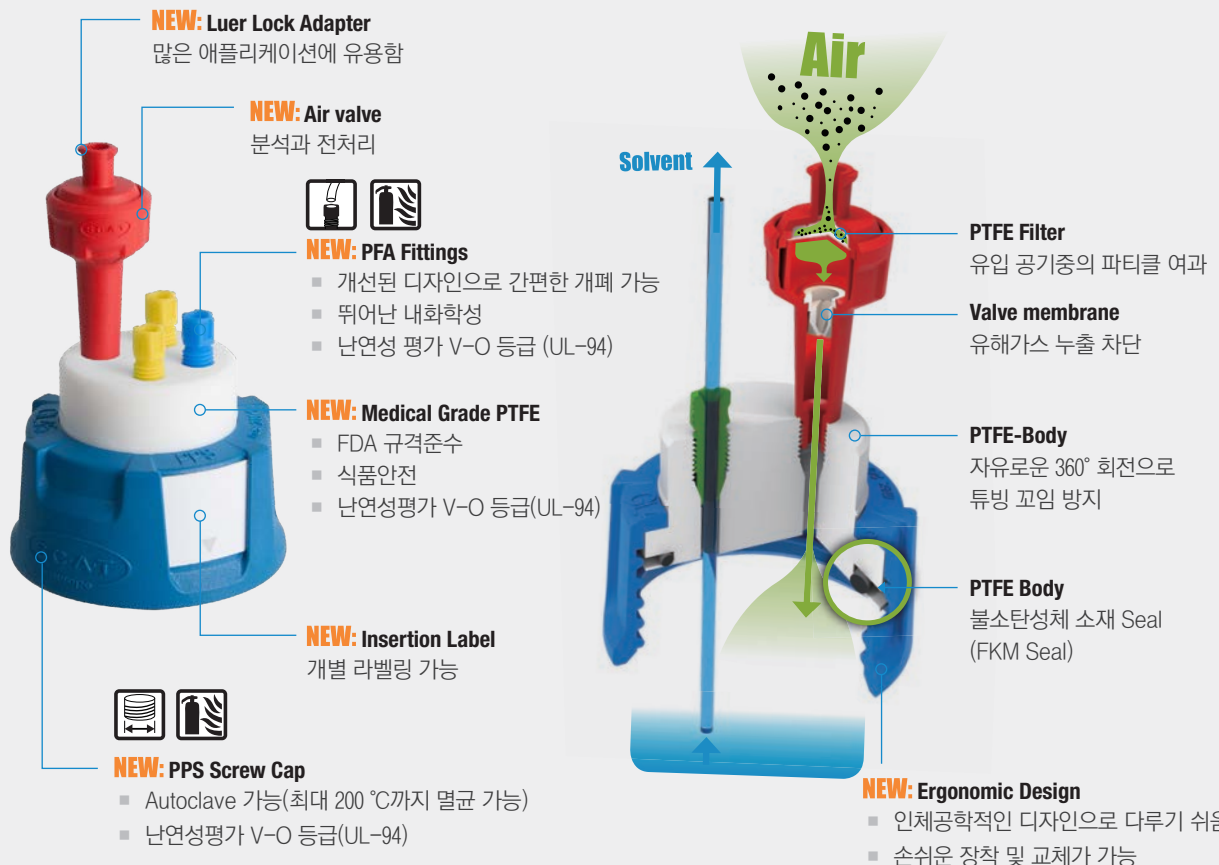

SafetyCaps 2.0 (GL45 Thread)

* Air valve and Fittings for tubing connection are included in delivery.



Part No.	Description	Unit	Thread size	Connections for Ø 3.2 mm (1/8") OD tubing	Blind plugs for tubing connections
307 019	SafetyCap I (V 2.0) *	1	GL 45	1x	-
307 909	SafetyCap II (V 2.0) *	1	GL 45	2x	1x
307 910	SafetyCap III (V 2.0) *	1	GL 45	3x	2x
307 410	SafetyCap IV (V 2.0) *	1	GL 45	4x	2x
307 520	SafetyCap VI (V 2.0) *	1	GL 45	6x	2x
317 010	Air valve for SafetyCaps	1	UNF 1/4" 28G	-	-
397 010	Air valve for SafetyCaps	10	UNF 1/4" 28G	-	-
107 063	Fitting for Ø 3.2 mm OD tubing, blue	5	UNF 1/4" 28G	-	-
107 060	Fitting for Ø 3.2 mm OD tubing, black	5	UNF 1/4" 28G	-	-
107 065	Fitting for Ø 3.2 mm OD tubing, yellow	5	UNF 1/4" 28G	-	-
160 501	Blind plug for tubing connections	10	UNF 1/4" 28G	-	-

SafetyCaps 2.0 HPLC Starter Kits



Feature

- 날개 구매 시와 비교하여 보다 합리적 가격으로 구매 가능
- 거의 모든 HPLC 시스템과 호환 사용 가능
- 사용하지 않는 피팅의 경우, 여분의 Blind plug로 밀폐하여 사용 (Blind plug 기본 포함)



Fig.	Part No.	Description	Content	Unit	Thread size	Connections for Ø 3.2 mm OD tubing
A	399 200	Starter-Kit-Supply-S1	SafetyCap I (V 2.0)	3x	GL 45	1x
			SafetyCap II (V 2.0)	1x	GL 45	2x
			Blind plug for tubing connection	1x	UNF 1/4" 28G	-
B	399 201	Starter-Kit-Supply-S2	SafetyCap II (V 2.0)	4x	GL 45	2x
			Blind plug for tubing connection	4x	UNF 1/4" 28G	-

Technology of SafetyWasteCap 2.0

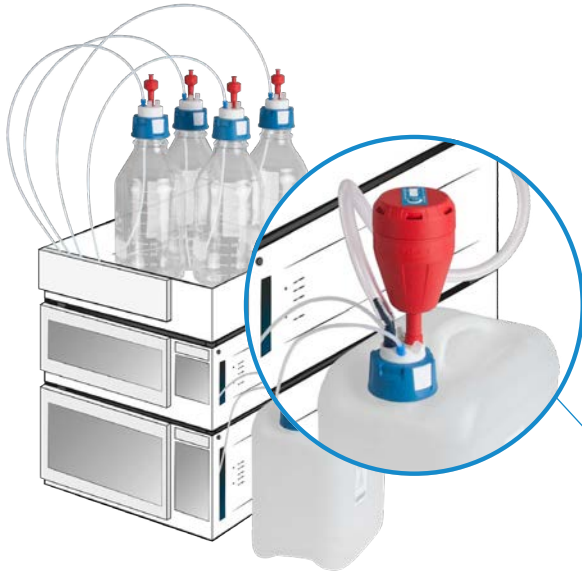

Feature

- 유해 증기 누출을 차단하는 필터 시스템
- 다양한 Thread 크기 선택 가능 (GL45~S95)
- Exhaust Filter는 필수 구성요소로 모든 용매 증기 필터에 최적화 되어 있으며, 활성탄을 기본으로 99% 휘발성 물질을 포집함
- 다양한 크기의 Exhaust Filter 선택 가능
- PTFE 및 PE-HD재질로 우수한 내화학성
- 유기 용매, 산 염기 용매에도 안전

Safety Waste Cap Part

NEW: 2가지 Exhaust Filter



NEW: With label
필터 교체 예정일을
수기 작성 가능

With change indicator
버튼을 눌러 수명 주기
인디케이터를 활성화



NEW: PFA Fittings

- 개선된 디자인으로 간편한 개폐 가능
- 뛰어난 내화학성
- 난연성평가 V-0 등급(UL-94)

NEW: Medical Grade PTFE

- FDA 규격준수
- 식품안전
- 난연성평가 V-0 등급(UL-94)

NEW: Insertion Label
개별 라벨링 가능



NEW: PPS Screw Cap

- Autoclave 가능(최대 200 °C까지 멸균)
- 난연성평가 V-0 등급(UL-94)

NEW: Ergonomic Design

- 인체공학적인 디자인으로 다루기 쉬움
- 손쉬운 장착 및 교체가 가능



UL-94에 따른 난연성 등급

UL-94는 플라스틱에 대한 난연성평가에 따른 국제표준규격입니다. IEC/DIN EN 60695-11-10 와-20에서 찾을 수 있습니다. V-0는 플라스틱 재료에 대한 아래의 사양을 갖춘 최고 등급입니다.

- 적하에 의한 탈지면이 발화되지 않습니다.
- 최대 여운 30초 이내

PE Filter Membrane

활성 탄소를 안정화
하고 적절한 공기
투과성을 제공

Functional Layers

안전성을 위한 3가지
유형의 활성탄

3rd layer

- binds acids

2nd layer

- binds alkalis

1st layer

- adsorbs solvent vapours



Fire Protection

- 부분적 결정 PP로 만든 하우징
- 난연성평가 V-0 등급 (UL-94)

PTFE-Body

자유로운 360°
회전으로
튜브 포임 방지

Filtered Exhaust Air

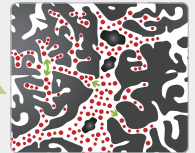
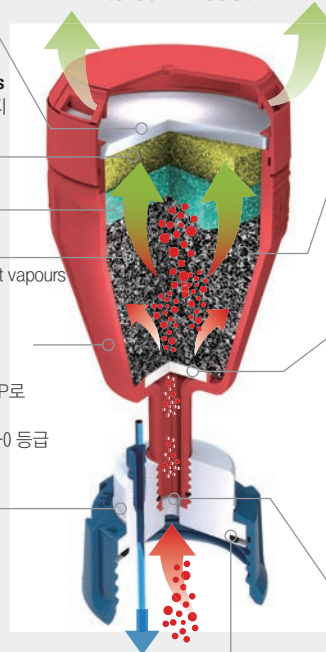

S.C.A.T.

Active Carbon (활성탄)
흡착표면적이 25%증가된
1,500 m²/g 활성 필터 표면으로
용매증기와 VOCs (휘발성
유기 화합물)에 최적화



PE Pre-Filter

활성탄 보호 및 용매증기에
대한 최적 flow 제공



Exhaust Filter with FKM Seal

(불소탄성체 소재 Seal)
필터를 단단히 고정시키고
용매증기의 유출 방지



PTFE Body with integrated FKM Seal

용매 용기에 완벽한 밀폐 제공

SafetyWasteCap 2.0 (S60/61 Thread)

Feature

- 보편적으로 사용하는 S60/61 Thread 안전 폐액 캡
- 새롭게 리뉴얼된 SafetyWasteCap 2.0
- 비스듬한 core : 더 많은 applications 사용 가능
- 향상된 핸들링, 간편한 설치 및 편리한 교체
- Blind plug로 사용 하지 않은 연결을 잠금 가능

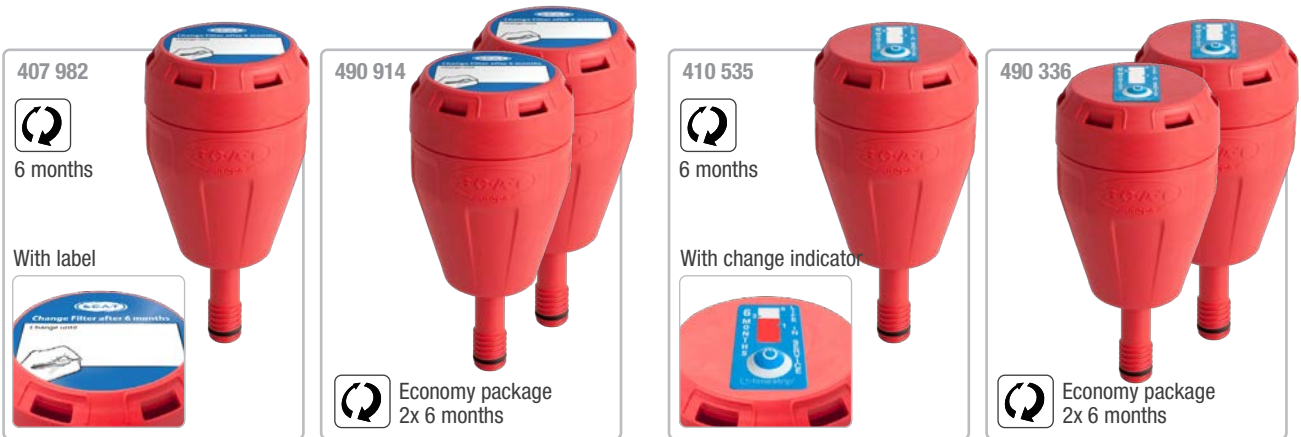

라벨 기입형 (with label)

필터 교체 예정일의 수기 작성 가능

교체 주기 인디케이터형 (With change indicator)

타임스트립이 장착되어 필터의 잔여 수명을 육안으로 확인 가능

Part No.	Description	Thread size	Connections for Ø 1.6 / 2.3 / 3.2 mm OD tubing	Connections for Ø 6.4 - 9 mm ID tubing	Service life (in months)	Unit
307 500	SafetyWasteCap S 60/61, V2.0, Universal	S 60/61	3 x	3 x	-	1
307 918	SafetyWasteCap S 60/61, V2.0, Universal	S 60/61	3x	-	-	1
307 925	SafetyWasteCap S 60/61, V2.0, Universal	S 60/61	2x	1x	-	1
407 982	Exhaust Filter M, V3.0, with splash guard and change label	GL 14	-	-	6	1
490 914	Exhaust Filter M, V3.0, economy pack., with splash guard and change label	GL 14	-	-	2 x 6	2
410 535	Exhaust Filter M, V3.0, with splash guard and change indicator	GL 14	-	-	6	1
490 336	Exhaust Filter M, V3.0, economy pack., with splash guard and change indicator	GL 14	-	-	2 x 6	2

SafetyWasteCap 2.0 (GL45 Thread)



라벨 기입형 (with label)

필터 교체 예정일의 수기 작성 가능

교체 주기 인디케이터형 (With change indicator)

타임스트립이 장착되어 필터의 잔여 수명을 육안으로 확인 가능

Fig.	Part No.	Description	Thread size	Connections for Ø 2.3 / 3.2 mm OD tubing	Connections for Ø 6.4 - 9 mm ID tubing	Blind plugs for tubing connection	Service life (in months)	Unit
A	307 912	SafetyWasteCap GL 45, V2.0	GL 45	3 x	-	1 x	-	1
B	307 923	SafetyWasteCap GL 45, V2.0	GL 45	2 x	1 x	2 x	-	1
C	308 921	SafetyWasteCap GL 45, V2.0	GL 45	4 x	1 x	2 x	-	1
D	407 982	Exhaust Filter M, V3.0, with splash guard and change label	GL 14	-	-	-	6	1
E	490 914	Exhaust Filter M, V3.0, economy pack., with splash guard and change label	GL 14	-	-	-	2 x 6	2
F	410 535	Exhaust Filter M, V3.0, with splash guard and change indicator	GL 14	-	-	-	6	1
G	490 336	Exhaust Filter M, V3.0, economy pack, with splash guard and change indicator	GL 14	-	-	-	2 x 6	2

Exhaust Filter V3.0 (For Safety Waste Cap)

Exchange Label ("Time Strip")

Activate it by
pressing a button!



Feature

- 안전 폐액 캡의 필수 구성 요소인 배기필터
- 모든 용매 증기 필터에 최적
- 흡착 표면적이 25% 증가된 Active Carbon 3.0
- Economy package 구입 가능
- 배기필터 (Exhaust filter) L 구입시 저렴한 비용으로 오랜 기간 사용 가능
- 수명 주기 : S (3개월) / M (6개월) / L (12개월) - 1EA 기준

Specification		Test Method
Ball-Pan Hardness (weight percent)	96%	ASTM D 3802
Inner Surface Area	1,500 m ² /g	DIN ISO 9277
Shake Density	415 ± 30 kg/m ³	ASTM D 2854
CTC-Adsorption (weight percent)	> 90 %	ASTM D 3467
Granulate Diameter	1.4 - 3 mm	ASTM D 2862
Ash Content (weight percent)	max. 5 %	ASTM D 2866
Water Content (weight percent)	max. 5 %	ASTM D 2867

490 335 **A**

Filter-Size S

490 336 **B**

You save 28%**

Filter-Size M

407 986 **C**

You save 35%**

Filter-Size L

Fig.	Part No.	Description	Service life	Unit
-	410 534	Exhaust Filter S, V3.0, with splash guard and change indicator	3 months	1
A	490 335	Exhaust Filter S, V3.0, economy pack., with splash guard and change indicator	4 x 3 months	4
-	407 982	Exhaust Filter M, V3.0, with splash guard and change label	6 months	1
-	490 914	Exhaust Filter M, V3.0, economy pack., with splash guard and change label	2 x 6 months	2
-	410 535	Exhaust Filter M, V3.0, with splash guard and change indicator	6 months	1
B	490 336	Exhaust Filter M, V3.0, economy pack, with splash guard and change indicator	2 x 6 months	2
C	407 986	Exhaust Filter L, V3.0, with splash guard and change indicator	12 months	1
-	490 986	Exhaust Filter L, V3.0, economy pack, with splash guard and change indicator	2x 12 months	2

Safety Funnel (with Ball Valve)

Feature

- 볼 밸브형 안전 깔때기
- 폐액을 부어 버릴 때에만 자동으로 열림
- 큰 오염 물질 입자를 걸러주는 Sieve 포함
- 넓은 입구로 편리하게 폐액 처리 가능 (Ø 200 mm)
- PE-HD 재질로 만들어져 산에 의한 부식이 없음
- 다양한 Thread Size 선택 가능
- Black 제품은 전기 스파크로 인한 발화 위험을 방지하기 위해 클램프가 있는 접지 케이블이 포함되어 있음



Fig.	Part No.	Screw-Thread of Container	Lance	Electrically conductive	Delivery with Adapter
-	317 642	GL 45	●	-	-
-	317 622	GL 45	●	●	-
-	317 638	GL 45	-	●	-
-	317 649	S 50	●	-	●
-	317 629	S 50	●	●	●
-	317 644	S 51	●	-	●
-	317 624	S 51	●	●	●
-	317 632	B 53	●	-	●
-	317 645	S 55	●	-	-
-	317 625	S 55	●	●	-
A	317 641	S 60 / 61	●	-	-
B	317 621	S 60 / 61	●	●	-
-	317 634	S 60 / 61	-	●	-
-	317 646	S 65	●	-	●
-	317 626	S 65	●	●	●
-	317 648	S 70 / 71	●	-	●
-	317 628	S 70 / 71	●	●	●
-	317 647	B 83	●	-	●
-	317 627	B 83	●	●	●
-	317 643	S 90	●	-	●
-	317 623	S 90	●	●	●
-	317 635	S 95	●	●	●



Safety Funnel (with Hinged Lid)



Feature

- 덮개형 안전 깔때기
- 큰 오염 물질 입자를 걸러주는 Sieve 포함
- 넓은 입구로 편리하게 폐액 처리 가능 (Ø 140 mm)
- PE-HD 재질로 만들어져 산에 의한 부식이 없음
- 안전하고 완전한 밀폐를 위한 sealing ring
- Black 제품은 전기 스파크로 인한 발화 위험을 방지하기 위해 클램프가 있는 접지 케이블이 포함되어 있음



P/N	Thread Size	Lance	Earthing Cable with Clamp (incl.)	Material	Color	Integrated Level Control (with Float)	Removable Sieve
318 952	GL 45	-	-	PE-HD	white/blue	-	•
318 962	GL 45	-	•	PE-HD-ec	black	-	•
318 992	GL 45	•	-	PE-HD	white/blue	-	•
318 955	S 50	-	-	PE-HD	white/blue	-	•
318 985	S 50	•	•	PE-HD-ec	black	-	•
318 995	S 50	•	-	PE-HD	white/blue	-	•
318 953	S 51	-	-	PE-HD	white/blue	-	•
318 983	S 51	•	•	PE-HD-ec	black	-	•
318 993	S 51	•	-	PE-HD	white/blue	-	•
318 951	S 55	-	-	PE-HD	white/blue	-	•
318 961	S 55	-	•	PE-HD-ec	black	-	•
318 981	S 55	•	•	PE-HD-ec	black	-	•
318 991	S 55	•	-	PE-HD	white/blue	-	•
318 950	S 60/61	-	-	PE-HD	white/blue	-	•
318 960	S 60/61	-	•	PE-HD-ec	black	-	•
318 980	S 60/61	•	•	PE-HD-ec	black	-	•
318 990	S 60/61	•	-	PE-HD	white/blue	-	•
317 637	S 60/61	-	•	PE-HD-ec	black	X 150 mm	•
317 651	S 60/61	-	•	PE-HD-ec	black	X 190 mm	•
318 954	S 65	-	-	PE-HD	white/blue	-	•
318 964	S 65	-	•	PE-HD-ec	black	-	•
318 984	S 65	•	•	PE-HD-ec	black	-	•
318 994	S 65	•	-	PE-HD	white/blue	-	•

Cascade™ III.I (1,3차수)



Feature

- 1차 및 3차수 생산 장치
- 일반 상수공급으로 1차 및 3차 정제수 동시 생산 가능
- 1차 정제수 필요 생산량별 제품 선택 가능 (시간당 5, 10, 20, 30L)
- 1차수 공급량 기반하여 3차수 분당 2L 생산
- 본체 및 디스펜서는 각각에 장착된 모니터를 통해 실시간으로 생산수의 수질 결과를 한번에 확인 가능
- 전처리 모듈과 메인 유닛이 분리되어 손쉬운 필터 교체 (별도의 도구 불필요)
- 7인치 touch screen 및 한글 버전 탑재



정기적 필터 교체 알림

Output Water Quality

Water Type	III	I
Conductivity / Resistivity	< 5 $\mu\text{S}/\text{cm}$ @ 25°C	18.2 $\text{M}\Omega \cdot \text{cm}$ @ 25°C
TOC (ppb)	-	< 5 ****
Bacteria (CFU/ml)	< 0.01*	< 0.01*
Particles (> 0.2 μm)	< 1/ml *	< 1/ml *
Endotoxin (EU/ml)	-	< 0.001**
RNASE (pg/ml)	-	< 1***
DNASE (pg/ml)	-	< 5***
PROTEASE ($\mu\text{g}/\text{ml}$)	-	< 0.15***
Output Flow Rate	Up to 2 L/min	Up to 2 L/min

* With LWFS32302 final filter

** With LWFS32303 final filter

*** With TC004 final filter

**** With feed water TOC less than 2 ppm



1mm 이내의 물을 탐지할 수 있는
독창적인 하부 설계 및 누수센서 탑재
(기본 장착)

Dimension (mm)

System	H 575 x W 366 x D 492
Reservoir	H 1200/900/600 x W 390 x D 384
Pre-Treatment	H 463 x W 220 x D 380
Dispensing Station	H 845 x W 280 x D 300

Output Flow Rates

System	RO	Type III	Type I
Cascade III. I 5	5 L/h	≥ 2 L/min	Up to 2 L/min
Cascade III. I 10	10 L/h		
Cascade III. I 20	20 L/h		
Cascade III. I 30	30 L/h		

Cascada™ II.I (2,3차수)



Feature

- 2차수 제조장치
 - Buffer 제조, pH Solution, 반도체 공정
- 3차수 제조장치
 - 제약 등급의 Final filter를 사용
 - 다양한 이온 제거 카트리리지
 - Low TOC for sensitive analysis
 - Low Boron for ICP analysis
- 본체 및 디스펜서는 각각에 장착된 모니터를 통해 실시간으로 생산수의 수질 결과를 한번에 확인 가능
- 7인치 touch screen 및 한글 버전 탑재

Output Water Quality

Water Type	II	I
Resistivity (MΩ · cm @ 25℃)	> 5	18.2
TOC (ppb)	< 30****	< 5****
Bacteria (CFU/ml)	< 0.01*	< 0.01*
Particles (> 0.2 μm)	< 1/ml*	< 1/ml*
Endotoxin (EU/ml)	< 0.001**	< 0.001**
RNASE (pg/ml)	< 1***	< 1***
DNASE (pg/ml)	< 5***	< 5***
PROTEASE (μg/ml)	< 0.15***	< 0.15***
Output Flow Rate	Up to 2 L/min	Up to 2 L/min



메인 Display

- * With LWFS32302 final filter
- ** With LWFS32303 final filter
- *** With TC004 final filter
- **** With feed water TOC less than 2 ppm

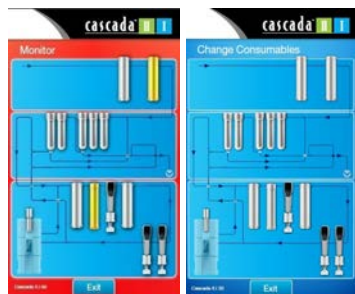

필터 교체 전/후

Dimension (mm)

System	H 575 x W 366 x D 492
Reservoir	H 1200/900/600 x W 390 x D 384
Pre-Treatment	H 463 x W 220 x D 380
Dispensing Station	H 845 x W 280 x D 300

Output Flow Rates

System	RO	Type II	Type I
Cascada II.I 5	5 L/h	≥ 2 L/min	Up to 2 L/min
Cascada II.I 10	10 L/h		
Cascada II.I 20	20 L/h		
Cascada II.I 30	30 L/h		

Cascada™ III (1차수)



Feature

- 일반 상수를 정제하여 1차 정제수를 생산
- 1차 정제수 필요 생산량별 제품 선택 가능 (시간당 5, 10, 20, 30L)
- 사용 용도 : 3차수 제조용 공급수, 멸균기 및 항온항습기용 공급수, 초자세척용 용수
- 본체에 장착된 모니터를 통해 실시간으로 생산수의 수질 결과를 한번에 확인 가능
- 7인치 touch screen 및 한글 버전 탑재

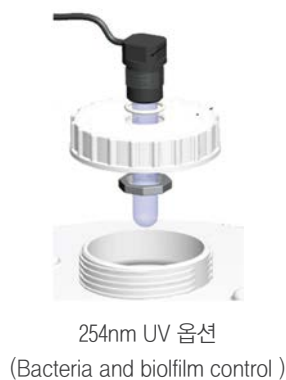
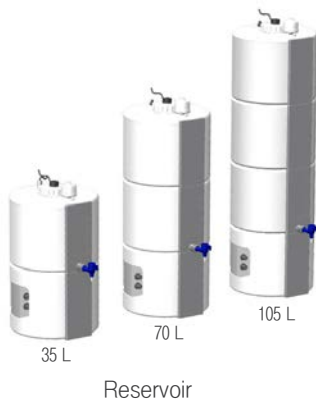

Output Water Quality

Water Type	III
Conductivity	< 5 μ S/cm @ 25°C (Typical)
Ion Rejection Rate	> 99%
Organic Rejection Rate	> 99%
Bacteria (CFU/ml)	< 0.01*
Particles (> 0.2 μ m)	< 1/ml *
Output Flow Rate	Up to 2 L/min

* With LWFS32302 final filter

Dimension (mm)

System	H 575 x W 366 x D 492
Reservoir	H 1200/900/600 x W 390 x D 384
Pre-Treatment	H 463 x W 220 x D 380
Dispensing Station	H 845 x W 280 x D 300

Output Flow Rates

System	RO	From tank	From dispenser
Cascada III 5	5 L/h	≥ 2 L/min*	Up to 2 L/min
Cascada III 10	10 L/h		
Cascada III 20	20 L/h		
Cascada III 30	30 L/h		

* With 0.2 μ m bacteria removal final filter

Cascada™ I (3차수)



Feature

- 분당 2L의 초순수 생산
- 제약 등급의 Final filter 선택 사용
 - 0.2um for bacteria removal
 - 0.1um for particulate removal
 - Positively-charged capsule for Rnases, Dnases and endotoxin removal
- 다양한 이온 제거 카트리지
 - Low TOC for sensitive analysis
 - Low Boron for ICP analysis
- 본체 및 디스펜서는 각각에 장착된 모니터를 통해 실시간으로 생산수의 수질 결과를 한번에 확인 가능
- 7인치 touch screen 및 한글 버전 탑재



디스펜서
(4단계 Drop방식, 최대 2L/min)

Output Water Quality

Water Type	I
Resistivity (MΩ · cm @ 25°C)	18.2
TOC (ppb)	< 5 ****
Bacteria (CFU/ml)	< 0.01
Particles (> 0.2 μm)	< 1/ml *
Endotoxin (EU/ml)	< 0.001 **
RNASE (pg/ml)	< 1***
DNASE (pg/ml)	< 5***
PROTEASE (μg/ml)	< 0.15****
Output Flow Rate	Up to 2 L/min

* With LWFS32302 final filter

** With LWFS32303 final filter

*** With TC004 final filter

**** With feed water TOC less than 50 ppb



디스펜서 Display
(0.1~ 90L까지 정량 분주 가능)

Dimension (mm)

System	H 575 × W 366 × D 492
Reservoir	H 1200/900/600 x W 390 x D 384
Dispensing Station	H 845 x W 280 x D 300



Injection Part | Column Accessories



Manual Injector (Rheodyne) 108

Automatic Valve (Rheodyne) 109

UHPLC Connection System 112

Fitting 113

Connector 116

Tubing 118

Column Accessories 122

HPLC Accessories 124

GC Accessories 126

Syringe 132

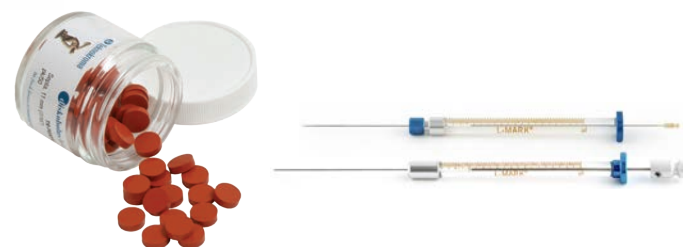

Injection Part | Column Accessories

Manual Injector (Rheodyne)



Made in USA

Manual Injector (Loop type)



Feature

- Stainless steel 316
- Analytical, Micro, Preparative scale 사용 가능
- Make-Before-Break (MBB) 구조로 시스템 내에 유입되는 압력 변화를 현저하게 완화시켜 주며 연속적인 흐름이 가능
- Built-in Position Sensing Switch가 있어 Injection시 시작 신호를 줌

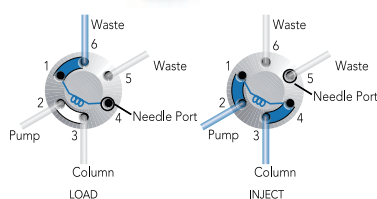

Flow path of the LOAD and INJECT position

Part No.*	Scale	Partial Filling	Sample Loop	Liquid Contact Materials	Max. psi	Max. T (°C)	MBB
7725,7725i	Analytical	1 µl - 2.5 ml	2 µl - 5.0 ml	316 SST, Vespel, Ceramic, PEEK	5,000	80°C	Yes
7125	Analytical	1 µl - 2.5 ml	5 µl - 5.0 ml		5,000	80°C	No
9725, 9725i	Analytical	1 µl - 5.0 ml	2 µl - 10 ml	PEEK, Tefzel, Ceramic	5,000	50°C	Yes
8125	Micro	0.1 µl - 500 ml	5 µl - 10 ml	316 SST, Vespel	5,000	80°C	No
3725 (i)-038	Preparative	100 µl - 10 µl	2.0 ml - 20 ml	316 SST	5,000	50°C	Yes
3725, 3725i	Preparative	100 µl - 10 µl	2.0 ml - 20 ml	PEEK	4,000	50°C	Yes
7010	Analytical	Not Applicable	5 µl - 5.0 ml	316 SST, Vespel	5,000	80°C	No
9010	Analytical		5 µl - 10 ml	PEEK, Tefzel, Ceramic	5,000	80°C	No
7410	Analytical		0.5 µl - 5 µl	316 SST, Vespel	5,000	80°C	No
7520	Micro		0.5 µl - 5 µl	316 SST, Vespel	5,000	80°C	No

*Part No. with an "i" suffix have a built-in position sensing switch. Models 8125 and 9010 each has a built-in switch.

Accessories & Spare Part



Sample Loop

Sample Loop

Part No.	Description	Tubing	Qty	Model
7755-021	10 µl Sample Loop, SUS	0.30mm ID X 1/16" OD	ea	7725, 7725i, MXII
7755-022	20 µl Sample Loop, SUS	0.30mm ID X 1/16" OD	ea	7725, 7725i, MXII
7755-023	50 µl Sample Loop, SUS	0.51mm ID X 1/16" OD	ea	7725, 7725i, MXII
7755-024	100 µl Sample Loop, SUS	0.51mm ID X 1/16" OD	ea	7725, 7725i, MXII
7755-025	200 µl Sample Loop, SUS	0.76mm ID X 1/16" OD	ea	7725, 7725i, MXII
7755-026	500 µl Sample Loop, SUS	0.76mm ID X 1/16" OD	ea	7725, 7725i, MXII
9055-021	10 µl Sample Loop, PEEK	0.25mm ID X 1/16" OD	ea	9725, 9010
9055-022	20 µl Sample Loop, PEEK	0.25mm ID X 1/16" OD	ea	9725, 9010
9055-023	50 µl Sample Loop, PEEK	0.51mm ID X 1/16" OD	ea	9725, 9010
9055-024	100 µl Sample Loop, PEEK	0.51mm ID X 1/16" OD	ea	9725, 9010
9055-025	200 µl Sample Loop, PEEK	0.51mm ID X 1/16" OD	ea	9725, 9010
9055-026	500 µl Sample Loop, PEEK	0.76mm ID X 1/16" OD	ea	9725, 9010



Rotor Seal & Stator

Replacement Part

Part No.	Description	Model	Qty
3725-085	Stator	3725-038, 3710-038, 3000-038, 3030-038	ea
7010-040	Stator	7010, 7125, 7000, 7030, 7040	ea
7725-010	Stator	7725, 7725i	ea
9125-043	Stator	9125, 9010, 9030, 9725, 9725i	ea
7010-039	Rotor Seal (Vespel)	7010, 7000, 7040	ea
7125-047	Rotor Seal (Vespel)	7125, 7725	ea
7010-071	Rotor Seal (Tefzel)	7010, 7010-087, 7000, 7040	ea
7125-079	Rotor Seal (Tefzel)	7125, 7125-081, 7725	ea
9125-082	Rotor Seal (Tefzel)	9125, 9725	ea
3725-999	RheBuild Kit	3725, 3725i, 3725-038, 3725i-038	ea
7010-999	RheBuild Kit	7010, 7010-type Valves	ea
7725-999	RheBuild Kit	7725, 7725i	ea
9725-999	RheBuild Kit	9725, 9725i	ea

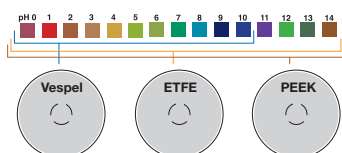

Injection Part I Column Accessories

Automatic Valve (Injection / Switching / Selection)



Made in USA

MXII Series



MXX
Low Pressure
Up to 125psi/9bar

MXT
Fast Chromatography
Up to 15,000psi/1000bar

MXP
High Pressure
Up to 6,000psi/400bar



Feature

- **Flexible Automation**
 - 분석장비 또는 PC (BCD, serial, USB)에 연결하기 위한 다양한 선택 사양
 - Remote Control 뿐만 아니라 LED 창에서 버튼을 눌러 직접 조작 가능
 - 각 Maker Chromatography software 또는 Titan MX software로 명령어 전달 가능
- **Reduce Downtime**
 - 부품 교체가 빠르고 용이한 POD 디자인
 - Titan EX fitting-less tubing connection system으로 쉽고 빠른 connections 교체
 - 밸브의 긴 수명
- **Increase Laboratory Capability**
 - Nano, Semi-Prep, Low Pressure, Fast chromatography (UHPLC)에 적용
 - 다양한 Flow Path
 - 믿을 수 있는 자동제어장치 Titan Valves
 - 시간 절약과 생산성 향상에 기여

Specification

Maximum Pressure	MXT : 15,000 psi (1,034 bar) MXP : 6,000 psi (414 bar) MXX : 125 psi (9 bar)
Flow Passages	Nano : 0.10 mm (0.004") diameter Analytical : 0.25 mm (0.010") diameter Preparative : 1.5 mm (0.060") diameter
Power Requirements	100-120 V _{AC} , 50-60 Hz
Regulatory Compliance	CE Mark
Remote Control	USB, I ² C, BCD, Level Logic
Operating Temperature	0~40°C, non-condensing
Storage Temperature	0~75°C
Dimensions (H x W x D)	117 mm x 76 mm x 128 mm (4.6" x 3.0" x 5.0")

Injection Part | Column Accessories

Automatic Valve (Injection / Switching / Selection)



Made in USA

MXII Series

Flow Path

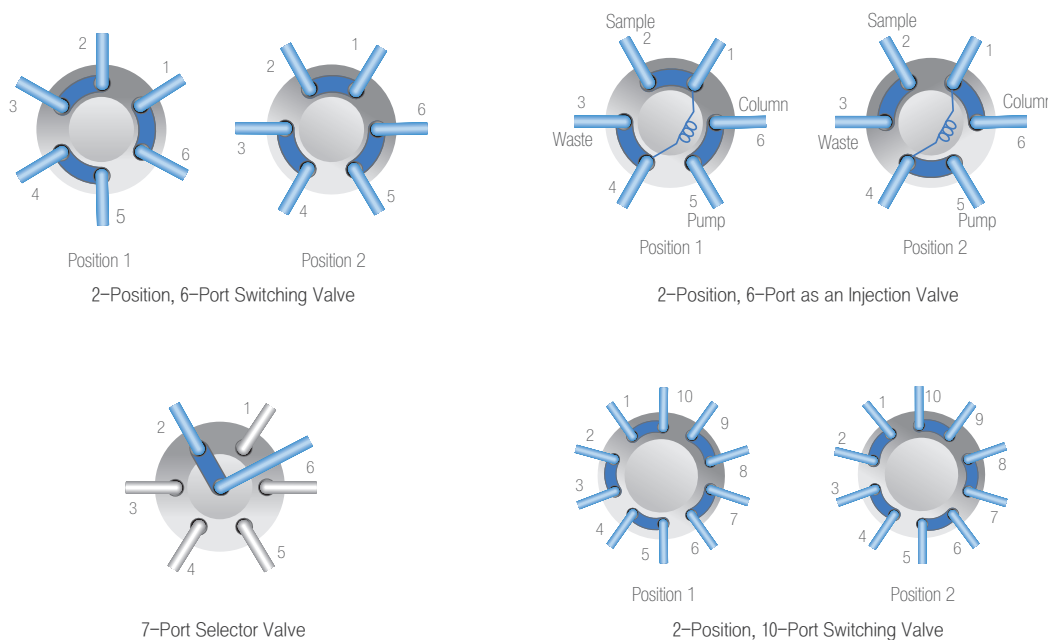

Application

- Sample Injection
- Two-Column Selection
- Alternating Column Regeneration
- High Speed Sample Enrichment
- High Speed Sample Clean Up
- Column Backflushing
- Multi-Dimensional Proteomic Peptide Separation
- Solvent Selection
- Fraction Collection
- Six Column Selection

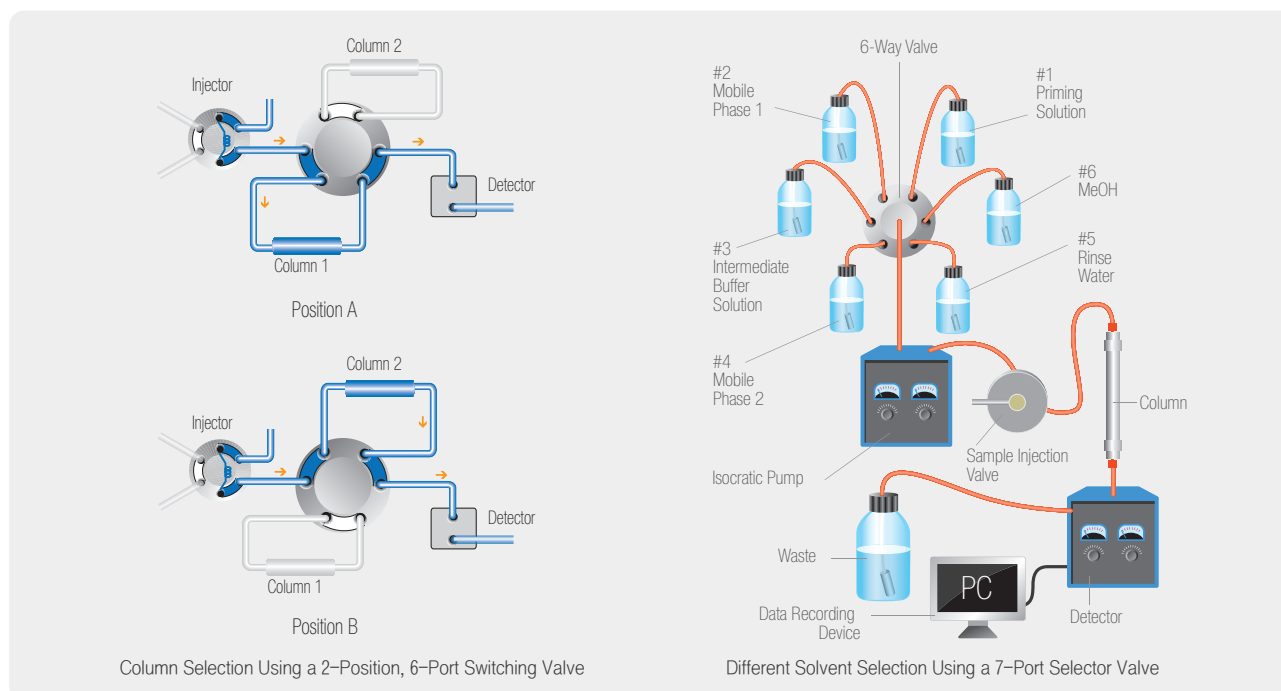

Injection Part I Column Accessories

Automatic Valve (Injection / Switching / Selection)



Made in USA

Injection Part I
Column Accessories

MXII Series



MXII Ordering Information

MXT for Fast Chromatography Applications, up to 15,000 psi (1,034 bar)

Part No.	Description	Material	Stator Passages
MXT715-000	2-position 6-port Switching Valve	Stainless Steel UltraLife	0.011" (0.28mm)
MXT715-102	2-position 10-port Switching Valve	Stainless Steel UltraLife	0.006" (0.15mm)
MXT715-105	6-position 7-port Selector Valve	Stainless Steel UltraLife	0.011" (0.28mm)

MXP for High pressure Applications, up to 6,000 psi (414 bar)

Part No.	Description	Material	Stator Passages
MXP7900-000	2-position 6-port Switching Valve	Stainless Steel DuraLife	0.012" (0.30 mm)
MXP7920-000	2-position 6-port Vertical Port Valve	Stainless Steel DuraLife	0.012" (0.30 mm)
MXP9900-000	2-position 6-port Switching Valve	PEEK	0.012" (0.30 mm)
MXP7960-000	2-position 10-port Switching Valve	Stainless Steel DuraLife	0.010" (0.25 mm)
MXP7970-000	6-position 7-port Selection Valve	Stainless Steel DuraLife	0.012" (0.30 mm)
MXP9960-000	2-position 10-port Switching Valve	PEEK	0.010" (0.25 mm)
MXP7980-000	2-position 6-port Nano Switching Valve	Titanium DuraLife	0.004" (0.10 mm)
MXP7986-000	2-position 10-port Nano Switching Valve	Titanium DuraLife	0.004" (0.10 mm)

MXX for Low Pressure Applications, up to 125 psi (9 bar)

Part No.	Description	Material	Stator Passages
MXX777-601	2-position 6-port Switching Valve	RPC-7	0.016" (0.41 mm)
MXX777-603	2-position Double Three-way Valve	RPC-7	0.016" (0.41 mm)
MXX777-605	6-position 7-port Selection Valve	RPC-7	0.040" (1.0 mm)
MXX777-612	2-position 6-port Switching Valve	RPC-7	0.060" (1.5 mm)
MXX777-616	6-position 7-port Switching Valve	RPC-7	0.060" (1.5 mm)
MXX778-605	10-position 11-port Selection Valve	RPC-7	0.060" (1.5 mm)

Accessories & Spare part

Part No.	For Valve Model No.
Sample Loop (For MXT715-000)	
7755-300	5 µl Sample Loop
7755-301	10 µl Sample Loop
7755-302	20 µl Sample Loop
7755-303	50 µl Sample Loop
7755-304	100 µl Sample Loop
Sample Loop (For MXII Valves)	
7755-020	5 µl Sample Loop
7755-021	10 µl Sample Loop
7755-022	20 µl Sample Loop
7755-023	50 µl Sample Loop
7755-024	100 µl Sample Loop
7755-025	200 µl Sample Loop
7755-026	500 µl Sample Loop
7755-027	1.0 ml Sample Loop
7755-028	2.0 ml Sample Loop
7755-029	5.0 ml Sample Loop

Part No.	For Valve Model No.
Stators	
7123-548	MXT715-000
7123-550	MXT715-105
7123-568	MXT715-102
7770-229	MXP7920-000
7980-004	MXP7980-000
7986-004	MXP7986-000
7900-146	MXP9900-000
7900-179	MXP7900-000
7900-183	MXP7970-000
7960-014	MXP7960-000
9960-002	MXP9960-000

Injection Part I Column Accessories

UHPLC Connection System



Made in USA

MarvelXACT™ UHPLC Fitting System



Feature

- 특허받은 torque-limiting 메커니즘으로 피팅 체결의 힘이 항상 일정
- 최적 토크에 도달할 때 “Click” 피드백을 제공하여 완벽한 연결 보장
- Finger-tight to 19,000 psi (1,310 bar / 130 MPa)
- Peak tailing, Peak broadening 최소화
- 다양한 Port 깊이에 맞게 자동 조정됨
- 100회 이상 연결 및 분리 가능
- Zero Dead Volume

Specification & Detail

Pressure Capability	19,000 psi (~1,310 bar, 131 MPa) for routine use
Installation Method	Finger-tighten until the first “click” feedback is received
Tubing Type	1/32" OD flexible 316 Stainless Steel with 1/16" OD rigid tube ends
Fitting Type	10-32 threaded, PEEK fittings with 316 Stainless Steel threads
Wetted Materials	PEEK-Lined versions : PEEK Stainless Steel versions : PEEK, 316 Stainless Steel
Max Use Temperature	120 °C

ID	150 MM Part No.	250 MM Part No.	350 MM Part No.	500 MM Part No.	600 MM Part No.
PEEK-Lined Stainless Steel Assemblies					
25 µm ID	UPFP-7025150	UPFP-7025250	UPFP-7025350	UPFP-7025500	UPFP-7025600
50 µm ID	UPFP-7050150	UPFP-7050250	UPFP-7050350	UPFP-7050500	UPFP-7050600
75 µm ID	UPFP-7075150	UPFP-7075250	UPFP-7075350	UPFP-7075500	UPFP-7075600
100 µm ID	UPFP-7100150	UPFP-7100250	UPFP-7100350	UPFP-7100500	UPFP-7100600
Stainless Steel Assemblies					
100 µm ID	UPFS-7100150	UPFS-7100250	UPFS-7100350	UPFS-7100500	UPFS-7100600
125 µm ID	UPFS-7125150	UPFS-7125250	UPFS-7125350	UPFS-7125500	UPFS-7125600
254 µm ID	UPFS-7254150	UPFS-7254250	UPFS-7254350	UPFS-7254500	UPFS-7254600

MarvelX™ UHPLC Fitting System



Feature

- Finger-tight to 19,000 psi (1,310 bar / 130 MPa)
- Peak tailing, Peak broadening 최소화
- 다양한 Port 깊이에 맞게 자동 조정됨
- 최대 200회 연결 및 분리 가능
- Zero Dead Volume

Specification & Detail

Pressure Capability	19,000 psi (~1,310 bar, 131 MPa) for routine use
Installation Method	Finger-tight, 1/8 of a turn (45° angle) after initial resistance
Tubing Type	1/32" OD flexible 316 Stainless Steel with 1/16" OD rigid tube ends
Fitting Type	10-32 threaded, removable 316 Stainless Steel
Wetted Materials	PEEK-Lined versions : PEEK Stainless Steel versions : PEEK, 316 Stainless Steel
Max Use Temperature	120 °C

ID	70 MM Part No.	150 MM Part No.	250 MM Part No.	350 MM Part No.	500 MM Part No.	600 MM Part No.
PEEK-Lined Stainless Steel Assemblies						
25 µm ID	UPFP-6025070	UPFP-6025150	UPFP-6025250	UPFP-6025350	UPFP-6025500	UPFP-6025600
50 µm ID	UPFP-6050070	UPFP-6050150	UPFP-6050250	UPFP-6050350	UPFP-6050500	UPFP-6050600
75 µm ID	UPFP-6075070	UPFP-6075150	UPFP-6075250	UPFP-6075350	UPFP-6075500	UPFP-6075600
100 µm ID	UPFP-6100070	UPFP-6100150	UPFP-6100250	UPFP-6100350	UPFP-6100500	UPFP-6100600
Stainless Steel Assemblies						
100 µm ID	UPFS-6100070	UPFS-6100150	UPFS-6100250	UPFS-6100350	UPFS-6100500	UPFS-6100600
125 µm ID	UPFS-6125070	UPFS-6125150	UPFS-6125250	UPFS-6125350	UPFS-6125500	UPFS-6125600
254 µm ID	UPFS-6254070	UPFS-6254150	UPFS-6254250	UPFS-6254350	UPFS-6254500	UPFS-6254600

VHP Fitting (UHPLC용)

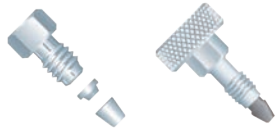

VHP-200x

VHP-3200x

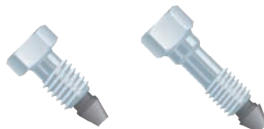

VHP-320x

VHP-325x

Feature

- 25,000~30,000 psi까지 사용 가능한 Very High Pressure (VHP) Fitting
- UHPLC System에 사용 가능
- Stainless Steel VHP Fitting : Double compression ferrule design
- Reusable VHP Fitting : PEEK재질 Ferrule로 Tubing 또는 Port의 손상 최소화

Part No.	Type	Description	Pressure Rating	Qty
VHP-200x	Stainless Steel VHP Fitting	For 1/16" OD Tubing, 10-32 Coned, SST	30,000 psi (2,070 bar)	10/pk
VHP-3200x	Reusable VHP Fitting	For 1/16" OD Tubing, 10-32 Coned, SST/pk	11,000 psi (760 bar)	10/pk
VHP-320x	Reusable VHP Fitting	For 1/16" OD Tubing, 10-32 Coned, SST/pk	25,000 psi (1,720 bar)	10/pk
VHP-325x	Reusable VHP Fitting	For 1/16" OD Tubing, Long, 10-32 Coned, SST/pk	25,000 psi (1,720 bar)	10/pk
VHP-920x	Reusable VHP Fitting	For 1/32" OD Tubing, M4 Coned, SST/pk	25,000 psi (1,720 bar)	10/pk

Stainless Steel Fitting

Standard Stainless Steel Fitting

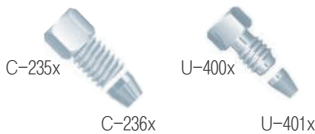

C-235x

U-400x

C-236x

U-401x

Common Valve Fitting

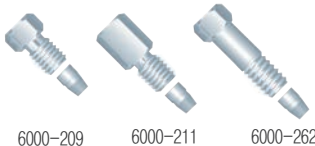

6000-209

6000-211

6000-262

Valco/VICI Compatible Fitting



U-320x

U-321x

Feature

- 20,000 psi까지 사용 가능한 316 Stainless Steel 재질 Fitting
- Type : Standard, Common Valve, Valco/VICI, Waters Compatible Fittings

Part No.	Type	Description	Pressure Rating	Qty
C-235x	Standard	Nut for 1/8" OD Tubing, 1/4-28 Coned	20,000 psi (1,380 bar)	10/pk
C-236x	Standard	Ferrule for 1/8" OD Tubing, 1/4-28 Coned	20,000 psi (1,380 bar)	10/pk
U-400x	Standard	Nut for 1/16" OD Tubing, 10-32 Coned	20,000 psi (1,380 bar)	10/pk
U-401x	Standard	Ferrule for 1/16" OD Tubing, 10-32 or M6 Coned	20,000 psi (1,380 bar)	10/pk
6000-209	Common Valve	Fitting for 1/16" OD Tubing, 10-32 Coned	20,000 psi (1,380 bar)	10/pk
6000-211	Common Valve	Fitting for 1/16" OD Tubing, Long, 10-32 Coned	20,000 psi (1,380 bar)	10/pk
6000-262	Common Valve	Fitting for 1/16" OD Tubing, Extra Long, 10-32 Coned	20,000 psi (1,380 bar)	10/pk
U-320x	Valco/VICI Compatible	Nut for 1/16" OD Tubing, 10-32 Coned	20,000 psi (1,380 bar)	10/pk
U-321x	Valco/VICI Compatible	Ferrule for 1/16" OD Tubing, 10-32 Coned	20,000 psi (1,380 bar)	10/pk
U-410x	Waters Compatible	Nut for 1/16" OD Tubing, 10-32 Coned	20,000 psi (1,380 bar)	10/pk

Wrench



Feature

- VHP Fitting, Stainless Steel Fitting용 Wrench
- IDEX Wrench는 1/16", 1/8" OD Tubing에 맞도록 흠이 있음

Part No.	Description	Qty
A-304	Wrench, 1/4" x 5/16"	ea
A-305	Wrench, 1/2" x 9/16"	ea
A-320	Wrench, 3/8" x 7/16"	ea
6810	IDEX Wrench, 1/4" x 5/16"	ea

Coned Type Fitting (10-32 Thread)

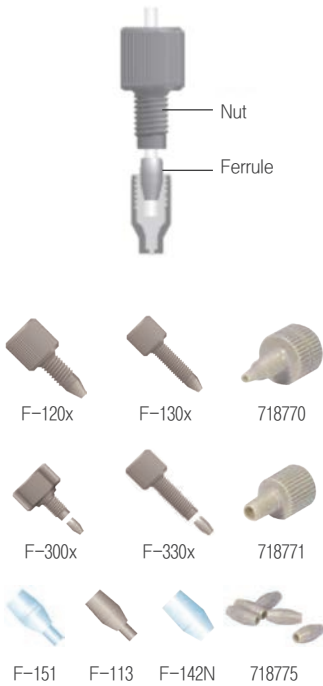

Feature

- High Pressure Fitting 으로 Pump Outlet과 Column 부분에 주로 사용
- 360 μ m, 1/32" OD, 1/16" OD Tubing 연결 피팅
- One-Piece Type : Nut와 Ferrule의 일체형
- Two-Piece Type : Nut와 Ferrule의 분리형 (Ferrule만 교체 가능)

10-32 Thread

- 10의 의미 : Thread 의 외경 Size가 Gauge 10 (3/16")
- 32의 의미 : 1인치당 32개의 Thread가 있음

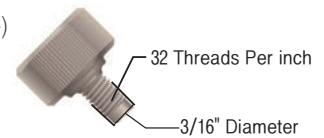

Part No.	Type	Description	Pressure Rating	Qty
F-120x	One-Piece	Fitting for 1/16" OD Tubing, 10-32 Coned, PEEK Natural	5,000 psi (345 bar)	10/pk
F-130x	One-Piece	Fitting for 1/16" OD Tubing, Long, 10-32 Coned, PEEK Natural	5,000 psi (345 bar)	10/pk
718770	One-Piece	Fitting for 1/16" OD Tubing, 10-32 Coned, PEEK Natural (Maker : MN)	5,000 psi (345 bar)	ea
F-300x	Two-Piece	Fitting for 1/16" OD Tubing, 10-32 Coned, Double Wing, PEEK Natural	6,000 psi (414 bar)	10/pk
F-330x	Two-Piece	Fitting for 1/16" OD Tubing, Long, 10-32 Coned, PEEK Natural	6,000 psi (414 bar)	10/pk
718771	Two-Piece	Nut for 1/16" OD Tubing, 10-32 Coned, PEEK Natural (Maker : MN)	6,000 psi (414 bar)	ea
F-151	Two-Piece	Replacement Ferrule for 360 μ m OD Tubing, 10-32 Coned, PCTFE Natural	6,000 psi (414 bar)	ea
F-113	Two-Piece	Replacement Ferrule for 1/32" OD Tubing, 10-32 Coned, PEEK Natural	6,000 psi (414 bar)	ea
F-142	Two-Piece	Replacement Ferrule for 1/16" OD Tubing, 10-32 Coned, PEEK Natural	6,000 psi (414 bar)	ea
F-142N	Two-Piece	Replacement Ferrule for 1/16" OD Tubing, 10-32 Coned, ETFE Natural	4,000 psi (276 bar)	ea
718775	Two-Piece	Double Ferrule for 1/16" OD Tubing, 10-32 Coned, PEEK Natural (Maker : MN)	6,000 psi (414 bar)	ea

Flat-Bottom Type Fitting (1/4-28 Thread)

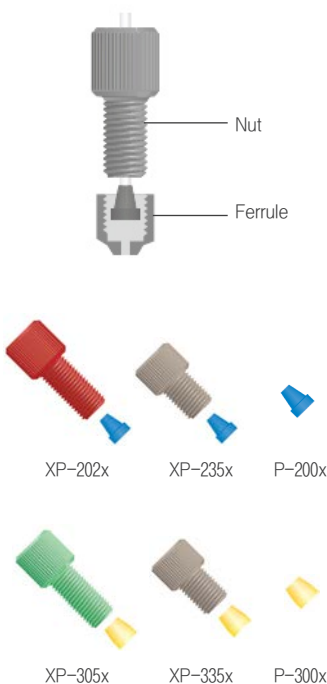

Feature

- Low Pressure Fitting으로 Pump Inlet 부분에 주로 사용
- 1/16" OD, 1/8" OD Tubing 연결 피팅
- 다양한 재질 및 색상 선택 가능

1/4-28 Thread

- 1/4의 의미 : Thread의 외경 Size가 1/4" (6.4mm)
- 28의 의미 : 1인치당 28개의 Thread가 있음

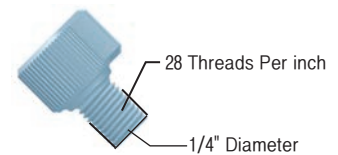

Part No.	Description	Pressure Rating	Qty
XP-201x	Fitting for 1/16" OD Tubing, 1/4-28 Flat-Bottom, Delrin Black	2,000 psi (138 bar)	10/pk
XP-202x	Fitting for 1/16" OD Tubing, 1/4-28 Flat-Bottom, Delrin Red	2,000 psi (138 bar)	10/pk
XP-218x	Fitting for 1/16" OD Tubing, 1/4-28 Flat-Bottom, ETFE Natural	2,000 psi (138 bar)	10/pk
XP-230x	Fitting for 1/16" OD Tubing, 1/4-28 Flat-Bottom, PEEK Natural	2,000 psi (138 bar)	10/pk
XP-235x	Fitting for 1/16" OD Tubing, Short, 1/4-28 Flat-Bottom, PEEK Natural	2,000 psi (138 bar)	10/pk
XP-245x	Fitting for 1/16" OD Tubing, 1/4-28 Flat-Bottom, PFA Natural	2,000 psi (138 bar)	10/pk
P-200x	Replacement Ferrule for 1/16" OD Tubing, 1/4-28 Flat-Bottom, ETFE Blue	2,000 psi (138 bar)	10/pk
XP-301x	Fitting for 1/8" OD Tubing, 1/4-28 Flat-Bottom, Delrin Black	500 psi (34 bar)	10/pk
XP-305x	Fitting for 1/8" OD Tubing, 1/4-28 Flat-Bottom, Delrin Green	500 psi (34 bar)	10/pk
XP-315x	Fitting for 1/8" OD Tubing, 1/4-28 Flat-Bottom, ETFE Natural	500 psi (34 bar)	10/pk
XP-330x	Fitting for 1/8" OD Tubing, 1/4-28 Flat-Bottom, PEEK Natural	500 psi (34 bar)	10/pk
XP-335x	Fitting for 1/8" OD Tubing, Short, 1/4-28 Flat-Bottom, PEEK Natural	500 psi (34 bar)	10/pk
P-300x	Replacement Ferrule for 1/8" OD Tubing, 1/4-28 Flat-Bottom, ETFE Yellow	500 psi (34 bar)	10/pk

MicroTight Fitting

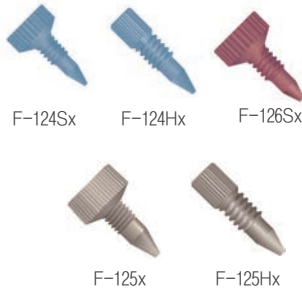

Feature

- 360 μm, 1/32" OD Tubing 연결 피팅
- MicroTight Sleeve를 사용하여 다양한 사이즈의 Capillary Tubing 연결 가능
- 6-32 Coned Thread, PEEK 재질

Part No.	Description	Pressure Rating	Qty
F-124Sx	Fitting for 360 μm OD Tubing, 6-32 Coned, Standard Knurl, PEEK Blue	5,000 psi (345 bar)	10/pk
F-124Hx	Fitting for 360 μm OD Tubing, 6-32 Coned, Headless Knurl, PEEK Blue	5,000 psi (345 bar)	10/pk
F-126Sx	Fitting for 1/32" OD Tubing, 6-32 Coned, Standard Knurl, PEEK Red	5,000 psi (345 bar)	10/pk
F-125x	Fitting for MicroTight Tubing Sleeve, 6-32 Coned, Standard Knurl, PEEK Natural	4,000 psi (276 bar)	10/pk
F-125Hx	Fitting for MicroTight Tubing Sleeve, 6-32 Coned, Headless Knurl, PEEK Natural	4,000 psi (276 bar)	10/pk

Tubing Sleeve



Feature

- Capillary Tubing을 연결할 수 있는 Fitting 규격이 없는 경우 사용
- Tubing Sleeve 안에 Capillary Tubing을 삽입한 후 Fitting에 연결하여 사용
- FEP, PEEK 재질 선택 가능

Part No.	Tubing Sleeve ID	For Tubing OD Size	Color	Qty
MicroTight PEEK Tubing Sleeve, For 0.025" OD MicroTight Fitting				
F-180	125 μm (0.005")	70-110 μm	Red	ea
F-181	180 μm (0.007")	125-165 μm	Yellow	ea
F-182	230 μm (0.009")	175-215 μm	Natural	ea
F-183	280 μm (0.011")	225-265 μm	Blue	ea
F-184	330 μm (0.013")	275-315 μm	Orange	ea
F-185	395 μm (0.0155")	340-380 μm	Green	ea
F-186	455 μm (0.018")	400-440 μm	Black	ea
F-187	535 μm (0.021")	480-520 μm	Natural	ea
F-188	152 μm (0.006")	95-135 μm	Purple	ea
FEP Tubing Sleeve, For 1/16" OD Fitting				
F-237	125 μm (0.005")	70-110 μm	Red	ea
F-238	180 μm (0.007")	125-165 μm	Yellow	ea
F-239	215 μm (0.0085")	160-200 μm	Natural	ea
F-240	280 μm (0.011")	225-265 μm	Blue	ea
F-241	330 μm (0.013")	275-315 μm	Orange	ea
F-242	395 μm (0.0155")	340-380 μm	Green	ea
F-243	455 μm (0.018")	400-440 μm	Black	ea
F-244	535 μm (0.021")	480-520 μm	Natural	ea
F-245	610 μm (0.024")	555-595 μm	Red	ea
F-246	685 μm (0.027")	630-670 μm	Yellow	ea
F-247	840 μm (0.033")	785-825 μm	Green	ea
F-252	1.07mm (0.042")	1mm	Purple	ea
PEEK Tubing Sleeve, For 1/16" OD Fitting				
F-225	125 μm (0.005")	70-110 μm	Red	ea
F-226	180 μm (0.007")	125-165 μm	Yellow	ea
F-227	230 μm (0.009")	175-215 μm	Yellow	ea
F-228	250 μm (0.011")	225-265 μm	Blue	ea
F-229	330 μm (0.013")	275-315 μm	Natural	ea
F-230	405 μm (0.016")	350-390 μm	Orange	ea
F-231	560 μm (0.022")	505-545 μm	Natural	ea
F-232	785 μm (0.031")	730-770 μm	Natural	ea
F-233	865 μm (0.034")	785-825 μm	Blue	ea
F-234	685 μm (0.027")	630-670 μm	Yellow	ea
PEEK Tubing Sleeve, For 1/32" OD Fitting				
F-381	180 μm (0.007")	125-165 μm	Yellow	ea
F-382	205 μm (0.008")	150-190 μm	Natural	ea
F-384	255 μm (0.010")	200-240 μm	Blue	ea
F-385	380 μm (0.015")	325-365 μm	Natural	ea
F-386	510 μm (0.020")	455-495 μm	Orange	ea
F-387	250 μm (0.011")	225-265 μm	Red	ea
F-388	330 μm (0.013")	275-315 μm	Black	ea
FEP Tubing Sleeve, For 1/32" OD Fitting				
F-374	280 μm (0.011")	225-265 μm	Blue	ea
F-375	330 μm (0.013")	275-315 μm	Orange	ea
F-376	395 μm (0.0155")	340-380 μm	Green	ea



Tubing Sleeve 안에 Capillary Tubing을 삽입하여 Fitting에 연결된 모습

VHP Connector (UHPLC용)

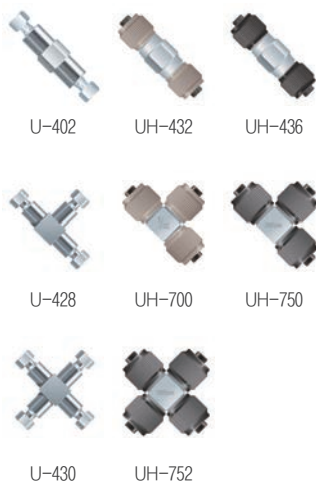

Feature

- UHPLC System에 사용 가능한 Very High Pressure용 Connector
- 360 μ m, 1/32" OD, 1/16" OD Tubing 연결 가능
- Type : Union, Tee, Cross Connector

Part No.	Type	Description	Thru-hole	Pressure Rating	Qty
U-402	Union	Stainless Steel Union for 1/16" OD Tubing, 10-32 Coned	0.50 mm	20,000 psi (1,380 bar)	ea
U-435	Union	Stainless Steel Union for 1/16" OD Tubing, 10-32 Coned	0.25 mm	20,000 psi (1,380 bar)	ea
UH-402	Union	VHP Stainless Steel Union for 1/16" OD Tubing, 10-32 Coned	0.25 mm	30,000 psi (2,070 bar)	ea
UH-432	Micro Union	VHP Micro Union for 1/32" OD Tubing, PEEK/SST, 5/16-24 Coned	0.15 mm	15,000 psi (1,034 bar)	ea
UH-436	Micro Union	VHP Micro Union for 360 μ m OD Tubing, PEEK/SST, 5/16-24 Coned	0.15 mm	15,000 psi (1,034 bar)	ea
U-428	Tee	Stainless Steel Tee for 1/16" OD Tubing, 10-32 Coned	0.50 mm	20,000 psi (1,380 bar)	ea
U-429	Tee	Stainless Steel Tee for 1/16" OD Tubing, 10-32 Coned	1.00 mm	20,000 psi (1,380 bar)	ea
UH-427	Tee	VHP Stainless Steel Tee for 1/16" OD Tubing, 10-32 Coned	0.50 mm	30,000 psi (2,070 bar)	ea
UH-700	Micro Tee	VHP Micro Tee for 1/32" OD Tubing, PEEK/SST, 5/16-24 Coned	0.25 mm	15,000 psi (1,034 bar)	ea
UH-750	Micro Tee	VHP Micro Tee for 360 μ m OD Tubing, PEEK/SST, 5/16-24 Coned	0.25 mm	15,000 psi (1,034 bar)	ea
U-430	Cross	Stainless Steel Cross for 1/16" OD tubing, 10-32 Coned	0.50 mm	20,000 psi (1,380 bar)	ea
U-431	Cross	Stainless Steel Cross for 1/16" OD tubing, 10-32 Coned	1.00 mm	20,000 psi (1,380 bar)	ea
UH-752	Micro Cross	VHP Micro Cross for 360 μ m OD Tubing, PEEK/SST, 5/16-24 Coned	0.25 mm	15,000 psi (1,034 bar)	ea

High Pressure Connector

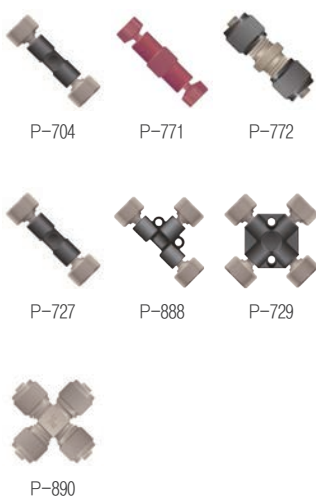

Feature

- High Pressure용 Connector
- 360 μ m, 1/32" OD, 1/16" OD Tubing 연결 가능
- MicroTight Sleeve를 사용하여 다양한 사이즈의 Capillary Tubing 연결 가능
- Type : Union, Tee, Cross Connector

Part No.	Type	Description	Thru-hole	Pressure Rating	Qty
P-704	Union	PEEK Union for 1/16" OD Tubing, 10-32 Coned	0.50 mm	5,000 psi (344 bar)	ea
P-742	Union	PEEK Union for 1/16" OD Tubing, 10-32 Coned	0.25 mm	5,000 psi (344 bar)	ea
P-760	Union	PEEK Union for 1/16" OD Tubing, 10-32 Coned	1.25 mm	5,000 psi (344 bar)	ea
P-771	Micro Union	PEEK Micro Union for 1/32" OD Tubing, 6-32 Coned	N/A	5,000 psi (345 bar)	ea
P-772	Micro Union	PEEK Micro Union for 360 μ m OD Tubing, 5/16-24 Coned	0.15 mm	5,000 psi (345 bar)	ea
P-727	Tee	PEEK Tee for 1/16" OD Tubing, 10-32 Coned	0.50 mm	3,500 psi (241 bar)	ea
P-728	Tee	PEEK Tee for 1/16" OD Tubing, 10-32 Coned	1.25 mm	3,500 psi (241 bar)	ea
P-775	Micro Tee	PEEK Micro Tee for MicroTight Sleeve, 5/16-24 Coned	0.15 mm	4,000 psi (276 bar)	ea
P-885	Micro Tee	PEEK Micro Tee for 1/32" OD Tubing, 5/16-24 Coned	0.15 mm	5,000 psi (345 bar)	ea
P-888	Micro Tee	PEEK Micro Tee for 360 μ m OD Tubing, 5/16-24 Coned	0.15 mm	5,000 psi (345 bar)	ea
P-729	Cross	PEEK Cross for 1/16" OD Tubing, 10-32 Coned	0.50 mm	3,500 psi (241 bar)	ea
P-777	Micro Cross	PEEK Micro Cross for MicroTight Sleeve, 5/16-24 Coned	0.15 mm	4,000 psi (276 bar)	ea
P-887	Micro Cross	PEEK Micro Cross for 1/32" OD Tubing, 5/16-24 Coned	0.15 mm	5,000 psi (345 bar)	ea
P-889	Micro Cross	PEEK Micro Cross for 360 μ m OD Tubing, 5/16-24 Coned	0.15 mm	5,000 psi (345 bar)	ea

Low Pressure Connector

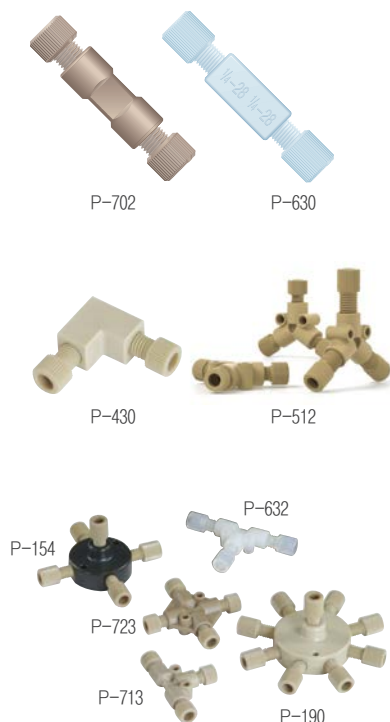

Feature

- Low Pressure용 Connector
- 1/16" OD, 1/8" OD Tubing 연결 가능
- PEEK, ETFE 재질 선택 가능
- Type : Union, Elbow, Tee, Y, Cross, Manifold Connector

Part No.	Type	Description	Thru-hole	Pressure Rating	Qty
P-702	Union	PEEK Union for 1/16" OD Tubing, 1/4-28 FB	0.50 mm	1,000 psi (69 bar)	ea
P-703	Union	PEEK Union for 1/8" OD Tubing, 1/4-28 FB	1.25 mm	1,000 psi (69 bar)	ea
P-630	Union	ETFE Union for 1/16" OD Tubing, 1/4-28 FB	N/A	1,000 psi (69 bar)	ea
P-631	Union	ETFE Union for 1/8" OD Tubing, 1/4-28 FB	N/A	1,000 psi (69 bar)	ea
P-710	Union	ETFE Union for 1/16" OD Tubing, 1/4-28 FB	0.75 mm	1,000 psi (69 bar)	ea
P-430	Elbow	PEEK Elbow for 1/16" OD Tubing, 1/4-28 FB	0.50 mm	1,000 psi (69 bar)	ea
P-432	Elbow	PEEK Elbow for 1/8" OD Tubing, 1/4-28 FB	1.60 mm	1,000 psi (69 bar)	ea
P-632	Tee	ETFE Tee for 1/16" OD Tubing, 1/4-28 FB	0.50 mm	1,000 psi (69 bar)	ea
P-633	Tee	ETFE Tee for 1/8" OD Tubing, 1/4-28 FB	1.25 mm	500 psi (34 bar)	ea
P-712	Tee	PEEK Tee for 1/16" OD Tubing, 1/4-28 FB	0.50 mm	1,000 psi (69 bar)	ea
P-713	Tee	PEEK Tee for 1/8" OD Tubing, 1/4-28 FB	1.25 mm	500 psi (34 bar)	ea
P-512	Y	PEEK Y for 1/16" OD Tubing, 1/4-28 FB	0.50 mm	1,000 psi (69 bar)	ea
P-513	Y	PEEK Y for 1/8" OD Tubing, 1/4-28 FB	1.00 mm	500 psi (34 bar)	ea
P-634	Cross	ETFE Cross for 1/16" OD Tubing, 1/4-28 FB	0.50 mm	1,000 psi (69 bar)	ea
P-635	Cross	ETFE Cross for 1/8" OD Tubing, 1/4-28 FB	1.25 mm	500 psi (34 bar)	ea
P-722	Cross	PEEK Cross for 1/16" OD Tubing, 1/4-28 FB	0.50 mm	1,000 psi (69 bar)	ea
P-723	Cross	PEEK Cross for 1/8" OD Tubing, 1/4-28 FB	1.25 mm	500 psi (34 bar)	ea
P-150	Manifold	PEEK 7-Port Manifold for 1/16" OD Tubing	1.00 mm	1,000 psi (69 bar)	ea
P-154	Manifold	PEEK 5-Port Manifold for 1/16" OD Tubing	1.00 mm	1,000 psi (69 bar)	ea
P-155	Manifold	PEEK 5-Port Manifold for 1/8" OD Tubing	1.60 mm	500 psi (34 bar)	ea
P-190	Manifold	PEEK 9-Port Manifold for 1/8" OD Tubing	1.60 mm	500 psi (34 bar)	ea
P-191	Manifold	PEEK 9-Port Manifold for 1/16" OD Tubing	1.00 mm	1,000 psi (69 bar)	ea

MicroTight Adapter

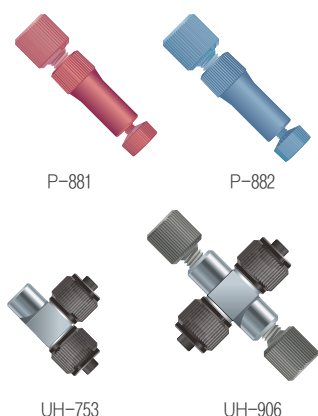

Feature

- 1/16" OD Tubing 과 1/32" OD Tubing 연결 또는 1/16" OD Tubing과 360 μm OD Tubing 연결시 사용
- Type : Adapter, Adapting Tee, Adapting Cross

Part No.	Type	Description	Pressure Rating	Qty
P-881	Adapter	PEEK Adapter, for 1/16" to 1/32" OD Tubing, Red	5,000 psi (345 bar)	ea
P-882	Adapter	PEEK Adapter, for 1/16" to 360 μm OD Tubing, Blue	5,000 psi (345 bar)	ea
UH-630	Adapter	Stainless Steel Adapter, for 1/16" to 1/32" OD Tubing, SST/Black	12,000 psi (827 bar)	ea
UH-634	Adapter	Stainless Steel Adapter, for 1/16" to 360 μm OD Tubing, SST/Black	12,000 psi (827 bar)	ea
UH-753	Adapting Tee	Stainless Steel Adapting Tee, for 1/16" to 360 μm OD Tubing, SST/Black	15,000 psi (1,035 bar)	ea
UH-906	Adapting Cross	Stainless Steel Adapting Cross, for 1/16" to 360 μm OD Tubing, SST/Black	15,000 psi (1,035 bar)	ea

Stainless Steel Tubing



Feature

- 내화학적, 내부식성이 우수한 316 Stainless Steel 로 Precut 되어 있음
- ID에 따라 Color Code화
- Size : 1/32", 1/16", 1/8" OD Tubing

Part No.	ID	Length	Color	Maximum Pressure
Stainless Steel Tubing, 1/32" OD				
U-1117	0.004" (0.10 mm)	12" (30 cm)	Red	19,300 psi (1,331 bar)
U-1128	0.008" (0.20 mm)	12" (30 cm)	Clear	17,800 psi (1,227 bar)
U-1133	0.010" (0.25 mm)	12" (30 cm)	Blue	16,200 psi (1,117 bar)
U-1143	0.015" (0.40 mm)	12" (30 cm)	Green	12,300 psi (848 bar)
U-1148	0.018" (0.45 mm)	12" (30 cm)	Black	10,000 psi (689 bar)
Stainless Steel Tubing, 1/16" OD				
U-157	0.005" (0.125 mm)	3.2' (1 m)	Red	21,600 psi (1,489 bar)
U-158	0.005" (0.125 mm)	5' (1.5 m)	Red	21,600 psi (1,489 bar)
U-160	0.005" (0.125 mm)	25' (7.6 m)	Red	21,600 psi (1,489 bar)
U-131	0.007" (0.175 mm)	3.2' (1 m)	Black	20,900 psi (1,441 bar)
U-108	0.007" (0.175 mm)	5' (1.5 m)	Black	20,900 psi (1,441 bar)
U-161	0.007" (0.175 mm)	25' (7.6 m)	Black	20,900 psi (1,441 bar)
U-133	0.010" (0.25 mm)	3.2' (1 m)	Blue	19,700 psi (1,358 bar)
U-106	0.010" (0.25 mm)	5' (1.5 m)	Blue	19,700 psi (1,358 bar)
U-162	0.010" (0.25 mm)	25' (7.6 m)	Blue	19,700 psi (1,358 bar)
U-135	0.020" (0.5 mm)	3.2' (1 m)	Yellow	15,800 psi (1,089 bar)
U-105	0.020" (0.5 mm)	5' (1.5 m)	Yellow	15,800 psi (1,089 bar)
U-163	0.020" (0.5 mm)	25' (7.6 m)	Yellow	15,800 psi (1,089 bar)
U-137	0.030" (0.75 mm)	3.2' (1 m)	White	12,000 psi (827 bar)
U-107	0.030" (0.75 mm)	5' (1.5 m)	White	12,000 psi (827 bar)
U-164	0.030" (0.75 mm)	25' (7.6 m)	White	12,000 psi (827 bar)
U-143	0.040" (1.0 mm)	3.2' (1 m)	N/A	8,100 psi (558 bar)
U-144	0.040" (1.0 mm)	5' (1.5 m)	N/A	8,100 psi (558 bar)
U-165	0.040" (1.0 mm)	25' (7.6 m)	N/A	8,100 psi (558 bar)
Stainless Steel Tubing, 1/8" OD				
U-800	0.080" (2.0 mm)	3.2' (1 m)	N/A	7,600 psi (524 bar)
U-803	0.080" (2.0 mm)	9.8' (3 m)	N/A	7,600 psi (524 bar)
U-805	0.080" (2.0 mm)	16' (5 m)	N/A	7,600 psi (524 bar)

Fused Silica Tubing

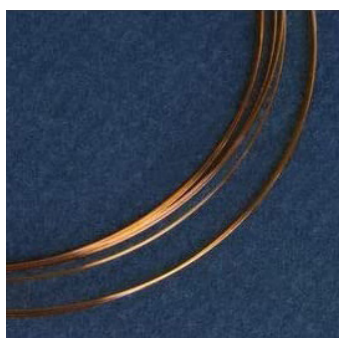

Feature

- Polyimide 코팅이 된 Synthetic fused silica로 제조
- Size : 360µm OD Tubing

Part No.	ID X Length	Color	Maximum Pressure
FS-120	20 µm (0.0008") ID x 6.4' (2 m)	Natural	10,000 psi (690 bar)
FS-150	50 µm (0.002") ID x 6.4' (2 m)	Natural	10,000 psi (690 bar)
FS-175	75 µm (0.003") ID x 6.4' (2 m)	Natural	10,000 psi (690 bar)
FS-110	100 µm (0.004") ID x 6.4' (2 m)	Natural	10,000 psi (690 bar)
FS-115	150 µm (0.006") ID x 6.4' (2 m)	Natural	10,000 psi (690 bar)

PEEK Tubing



Feature

- 고압, 고온에서 사용가능 (up to 7,000 psi)
- 단단하여 마모에 강하며 대부분 용매에 호환 가능 (강산 제외)
- ID에 따라 Color Code화 되어있음
- Size : 360 μ m, 1/32", 1/16", 1/8" OD Tubing

Part No.	ID X Length	Color	Maximum Pressure
PEEK Tubing, 1/16" OD			
1560	0.0025" (65 μ m) ID x 5' (1.5 m)	Natural	7,000 psi (483 bar)
1560L	0.0025" (65 μ m) ID x 50' (15 m)	Natural	7,000 psi (483 bar)
1561	0.004" (0.10 mm) ID x 5' (1.5 m)	Black	7,000 psi (483 bar)
1561L	0.004" (0.10 mm) ID x 50' (15 m)	Black	7,000 psi (483 bar)
1535	0.005" (0.125 mm) ID x 5' (1.5 m)	Red	7,000 psi (483 bar)
1535L	0.005" (0.125 mm) ID x 50' (15 m)	Red	7,000 psi (483 bar)
1536	0.007" (0.175 mm) ID x 5' (1.5 m)	Yellow	7,000 psi (483 bar)
1536L	0.007" (0.175 mm) ID x 50' (15 m)	Yellow	7,000 psi (483 bar)
1531	0.010" (0.25 mm) ID x 5' (1.5 m)	Natural	7,000 psi (483 bar)
1531L	0.010" (0.25 mm) ID x 50' (15 m)	Natural	7,000 psi (483 bar)
1531B	0.010" (0.25 mm) ID x 5' (1.5 m)	Blue	7,000 psi (483 bar)
1531BL	0.010" (0.25 mm) ID x 50' (15 m)	Blue	7,000 psi (483 bar)
1532	0.020" (0.50 mm) ID x 5' (1.5 m)	Orange	6,000 psi (414 bar)
1532L	0.020" (0.50 mm) ID x 50' (15 m)	Orange	6,000 psi (414 bar)
1533	0.030" (0.75 mm) ID x 5' (1.5 m)	Green	4,000 psi (276 bar)
1533L	0.030" (0.75 mm) ID x 50' (15 m)	Green	4,000 psi (276 bar)
1538	0.040" (1.00 mm) ID x 5' (1.5 m)	Natural	3,000 psi (207 bar)
1538L	0.040" (1.00 mm) ID x 50' (15 m)	Natural	3,000 psi (207 bar)
PEEK Tubing, 1/8" OD			
1534	0.062" (1.55 mm) ID x 5' (1.5 m)	Natural	4,000 psi (276 bar)
1544	0.080" (2.00 mm) ID x 5' (1.5 m)	Natural	3,000 psi (207 bar)
Capillary PEEK Tubing, 360μm OD			
1574	0.001" (25 μ m) ID x 5' (1.5 m)	Natural	5,000 psi (345 bar)
1570	0.002" (50 μ m) ID x 5' (1.5 m)	Natural	2,000 psi (138 bar)
1571	0.004" (100 μ m) ID x 5' (1.5 m)	Red	2,000 psi (138 bar)
1572	0.006" (150 μ m) ID x 5' (1.5 m)	Yellow	2,000 psi (138 bar)
Capillary PEEK Tubing, 1/32" OD			
1576	0.005" (0.125 mm) ID x 5' (1.5 m)	Red	5,000 psi (345 bar)
1576L	0.005" (0.125 mm) ID x 50' (15 m)	Red	5,000 psi (345 bar)
1577	0.007" (0.175 mm) ID x 5' (1.5 m)	Yellow	5,000 psi (345 bar)
1577L	0.007" (0.175 mm) ID x 50' (15 m)	Yellow	5,000 psi (345 bar)
1581	0.010" (0.25 mm) ID x 5' (1.5 m)	Blue	5,000 psi (345 bar)
1581L	0.010" (0.25 mm) ID x 50' (15 m)	Blue	5,000 psi (345 bar)
1568	0.015" (0.40 mm) ID x 5' (1.5 m)	Natural	4,000 psi (276 bar)
1568L	0.015" (0.40 mm) ID x 50' (15 m)	Natural	4,000 psi (276 bar)
1569	0.020" (0.50 mm) ID x 5' (1.5 m)	Orange	3,000 psi (207 bar)
1569L	0.020" (0.50 mm) ID x 50' (15 m)	Orange	3,000 psi (207 bar)

* 원하시는 길이로 판매 가능합니다.

Teflon[®] PFA Tubing

Feature

- 내부 표면이 매끄러워 화합물 이송이 용이하며 투명함
- 내화학성이 우수하며 강산에 사용 가능
- Gas 투과성이 적음
- Size : 1/16", 1/8" OD Tubing



Part No.	ID	Length	Color	Maximum Pressure
PFA Tubing, 1/16" OD				
1500	0.020" (0.50 mm)	5' (1.5 m)	Natural	2,000 psi (138 bar)
1512L	0.020" (0.50 mm)	50' (15 m)	Natural	2,000 psi (138 bar)
1512M	0.020" (0.50 mm)	1,000' (304 m)	Natural	2,000 psi (138 bar)
1502	0.030" (0.75 mm)	5' (1.5 m)	Natural	1,000 psi (69 bar)
1514L	0.030" (0.75 mm)	50' (15 m)	Natural	1,000 psi (69 bar)
1514M	0.030" (0.75 mm)	1,000' (304 m)	Natural	1,000 psi (69 bar)
1503	0.040" (1.0 mm)	5' (1.5 m)	Natural	500 psi (34 bar)
1507L	0.040" (1.0 mm)	50' (15 m)	Natural	500 psi (34 bar)
1507M	0.040" (1.0 mm)	1,000' (304 m)	Natural	500 psi (34 bar)
PFA Tubing, 1/8" OD				
1509-5	0.062" (1.55 mm)	5' (1.5 m)	Natural	500 psi (34 bar)
1509L	0.062" (1.55 mm)	50' (15 m)	Natural	500 psi (34 bar)
PFA HP Tubing, 1/16" OD				
1622-5	0.020" (0.50 mm)	5' (1.5 m)	Natural	2,000 psi (138 bar)
1622L	0.020" (0.50 mm)	50' (15 m)	Natural	2,000 psi (138 bar)
1622M	0.020" (0.50 mm)	1,000' (304 m)	Natural	2,000 psi (138 bar)
1632-5	0.030" (0.75 mm)	5' (1.5 m)	Natural	1,000 psi (69 bar)
1632L	0.030" (0.75 mm)	50' (15 m)	Natural	1,000 psi (69 bar)
1632M	0.030" (0.75 mm)	1,000' (304 m)	Natural	1,000 psi (69 bar)
PFA HP Tubing, 1/8" OD				
1641-5	0.062" (1.55 mm)	5' (1.5 m)	Natural	500 psi (34 bar)
1641L	0.062" (1.55 mm)	50' (15 m)	Natural	500 psi (34 bar)
PFA HP Plus Tubing, 1/16" OD				
1902-5	0.010 (0.25 mm)	5' (1.5 m)	Natural	3,000 psi (207 bar)
1902L	0.010 (0.25 mm)	50' (15 m)	Natural	3,000 psi (207 bar)
1902M	0.010 (0.25 mm)	1,000' (304 m)	Natural	3,000 psi (207 bar)
1907-5	0.020" (0.50 mm)	5' (1.5 m)	Natural	2,000 psi (138 bar)
1907L	0.020" (0.50 mm)	50' (15 m)	Natural	2,000 psi (138 bar)
1907M	0.020" (0.50 mm)	1,000' (304 m)	Natural	2,000 psi (138 bar)
1912-5	0.030" (0.75 mm)	5' (1.5 m)	Natural	1,000 psi (69 bar)
1912L	0.030" (0.75 mm)	50' (15 m)	Natural	1,000 psi (69 bar)
1912M	0.030" (0.75 mm)	1,000' (304 m)	Natural	1,000 psi (69 bar)
PFA HP Plus Tubing, 1/8" OD				
1921-5	0.062" (1.55 mm)	5' (1.5 m)	Natural	500 psi (34 bar)
1921L	0.062" (1.55 mm)	50' (15 m)	Natural	500 psi (34 bar)

* 원하시는 길이로 판매 가능합니다.

Teflon[®] FEP Tubing



Feature

- 비교적 낮은 압력에 사용 권장 (From 250 psi to 3,000 psi)
- 내화학성이 우수하며 강산에 사용 가능
- OD Size : 1/16", 1/8", 3/16", 1/4", 1mm, 2mm, 3mm

Part No.	ID	Length	Color	Maximum Pressure
FEP Tubing, 1/16" OD				
1527-5	0.010" (0.25 mm)	5' (1.5 m)	Natural	3,000 psi (207 bar)
1527L	0.010" (0.25 mm)	50' (15 m)	Natural	3,000 psi (207 bar)
1527XL	0.010" (0.25 mm)	100' (30 m)	Natural	3,000 psi (207 bar)
1548-5	0.020" (0.50 mm)	5' (1.5 m)	Natural	2,000 psi (138 bar)
1548L	0.020" (0.50 mm)	50' (15 m)	Natural	2,000 psi (138 bar)
1548XL	0.020" (0.50 mm)	100' (30 m)	Natural	2,000 psi (138 bar)
1520-5	0.030" (0.75 mm)	5' (1.5 m)	Natural	1,000 psi (69 bar)
1520L	0.030" (0.75 mm)	50' (15 m)	Natural	1,000 psi (69 bar)
1520XL	0.030" (0.75 mm)	100' (30 m)	Natural	1,000 psi (69 bar)
FEP Tubing, 1/8" OD				
1521-5	0.062" (1.55 mm)	5' (1.5 m)	Natural	500 psi (34 bar)
1521L	0.062" (1.55 mm)	50' (15 m)	Natural	500 psi (34 bar)
1521XL	0.062" (1.55 mm)	100' (30 m)	Natural	500 psi (34 bar)
FEP Tubing, 3/16" OD				
1524L	0.125" (3.2 mm)	50' (15 m)	Natural	500 psi (34 bar)
1524XL	0.125" (3.2 mm)	100' (30 m)	Natural	500 psi (34 bar)
FEP Tubing, 1/4" OD				
1650L	0.188" (4.8 mm)	50' (15 m)	Natural	250 psi (17 bar)
1650XL	0.188" (4.8 mm)	100' (30 m)	Natural	250 psi (17 bar)
FEP Tubing, 1.0mm OD				
1671L	0.020" (0.50 mm)	50' (15 m)	Natural	500 psi (34 bar)
1671XL	0.020" (0.50 mm)	100' (30 m)	Natural	500 psi (34 bar)
FEP Tubing, 2.0mm OD				
1673L	0.40" (1.0 mm)	50' (15 m)	Natural	500 psi (34 bar)
1673XL	0.40" (1.0 mm)	100' (30 m)	Natural	500 psi (34 bar)
FEP Tubing, 3.0mm OD				
1677L	0.080" (2.0 mm)	50' (15 m)	Natural	500 psi (34 bar)
1677XL	0.080" (2.0 mm)	100' (30 m)	Natural	500 psi (34 bar)

* 원하시는 길이로 판매 가능합니다.

Tubing Cutter



FS-315
For Fused silica tubing



A-327
For 1/16", 1/8" OD tubing
A-329
For 3/16" - 5/16" OD tubing



A-350
For Capillary polymer tubing



ANA1551
For Stainless Steel tubing

Precolumn Filter

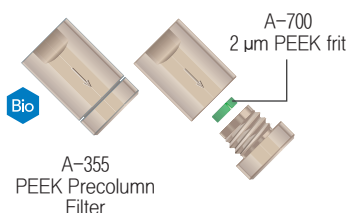
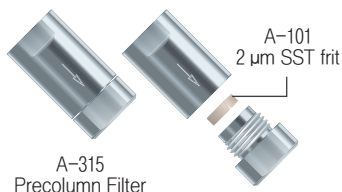

Feature

- Column 앞단에 사용
- 샘플과 섞인 이동상이 Column으로 들어가기 전에 Filtering
- Column의 수명을 증가시킴
- 10-32 Coned Fitting을 사용하여 1/16" OD Tubing을 연결할 수 있음
- 0.5 μm 또는 2 μm Porosity Frits 선택 가능

Part No.	Material	Description	Qty
A-315	Stainless Steel	2 μm Filter Assembly, with A-101 Frit	ea
A-318	Stainless Steel	0.5 μm Filter Assembly, with A-102 Frit	ea
A-101	Stainless Steel	2 μm Replacement Frit	ea
A-102	Stainless Steel	0.5 μm Replacement Frit	ea
A-355	PEEK	2 μm Filter Assembly, Biocompatible, with A-700 Frit	ea
A-356	PEEK	0.5 μm Filter Assembly, Biocompatible, with A-701 Frit	ea
A-700	PEEK	2 μm Replacement Frit	ea
A-701	PEEK	0.5 μm Replacement Frit	ea

Column Coupler

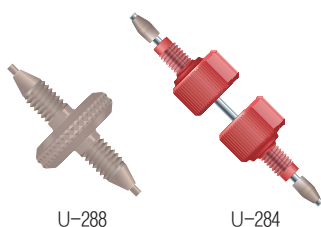

Feature

- Precolumn과 Analytical Column을 연결할 때 사용
- Guard Column과 Analytical Column을 연결할 때 사용
- Low Swept Volume

Part No.	Type	Description	Qty
U-281	Single Piece	For 10-32 Port, Kel-F, with .020" Thru-hole	ea
U-288	Single Piece	For 10-32 Port, PEEK, with .060" Thru-hole	ea
U-284	Traditional Coupler	For 10-32 Port, Delrin, with 0.007" ID Stainless Steel Tubing	ea
U-287	Traditional Coupler	For 10-32 Port, PEEK, with 0.010" ID PEEK Tubing	ea

Column Plug

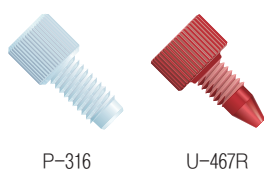

Feature

- 사용하지 않는 Port 부분을 막기 위해 사용
- Column 마감으로 사용

Part No.	Description	Head Style	Qty
P-316	Plug for 1/4-28 Flat-Bottom Port, PFA Natural	Standard Knurl	ea
P-309	Plug for 1/4-28 Flat-Bottom Port, Delrin Black	Standard Knurl	ea
U-467R	Plug for 10-32 Coned Port, Delrin Red	Standard Knurl	ea
VHP-600	VHP Plug for 10-32 Coned Ports, PK-SST	3/8" Hex	ea

Guard Column



Feature

- 1/16" 피팅용으로 모든 분석용 HPLC 컬럼에 적합
- NUCLEODUR®, NUCLEOSIL® 및 NUCLEOSHELL® HPLC 흡착제로 채워진 카트리지
- 메인 컬럼에 대한 이상적인 보호 → 컬럼 수명 증가
- Minimized dead volume → Ultra-fast HPLC에서도 적합
- 시각적 오염 점검이 가능하여 카트리지 교체 시점을 알 수 있음
- 특수 Ferrule → 최대 1300 bar (18,850 psi)의 압력까지 안정성
- Reversed-phase 조건에서 모든 HPLC 컬럼에 적합한 UNIVERSAL RP 가드 컬럼

Column Protection System



Part No.	Description	Pack of
718966	Guard column holder	1
	Capillaries (0.12 mm ID)	2
	Ferrules	3
	Wrenches	2
	Manual	1

Replacement parts for the Column Protection System

Part No.	Description	Qty
718967	Special ferrules made of PEEK	5/pk
718968	Replacement connector including O-ring	ea
718969	Stainless steel capillaries 0.12 mm ID, nuts and metal ferrules	3/pk
718971	Stainless steel capillaries 0.18 mm ID (for higher flow rates), nuts and metal ferrules	3/pk
718970	Wrench (size 12 and 14 mm)	ea
728777.20	EC 4/2 UNIVERSAL RP guard column (for main columns with 2 mm ID)	3/pk
728778.20	EC 4/2 UNIVERSAL RP guard column (for main columns with 2 mm ID), value pack	9/pk
728777.30	EC 4/3 UNIVERSAL RP guard column (for main columns with 3, 4 and 4.6 mm ID)	3/pk
728778.30	EC 4/3 UNIVERSAL RP guard column (for main columns with 3, 4 and 4.6 mm ID), value pack	9/pk

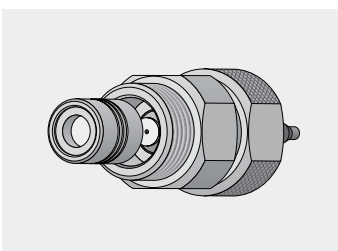

Visual contamination check

카트리지에는 특수한 Filter membrane이 장착되어 있음 :

- Silver membrane이 오염이 된 경우 (밝거나 어둡게 변색) 카트리지를 교체하는 것이 좋음
- 오염 물질이 무색인 경우에도 압력이 상승하거나 크로마토그래피 성능이 저하되면 카트리지를 교체해야 함

Back Pressure Regulators (BPRs)

Feature

- Detector 후단 : 40~100 psi BPRs 사용
- Pump 와 Injector 사이 : 500~1,000 psi BPRs 사용

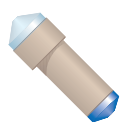

P-761
40 psi BPR
Cartridge

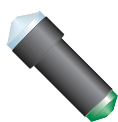

P-796
1,000 psi BPR
Cartridge

BPR Assemblies

Part No.	Holder Material	Description	Qty
U-605	Stainless Steel	40 psi (2.8bar) BPR Assemblies	ea
U-606	Stainless Steel	75 psi (5.2bar) BPR Assemblies	ea
U-607	Stainless Steel	100 psi (7bar) BPR Assemblies	ea
U-608	Stainless Steel	250 psi (17bar) BPR Assemblies	ea
U-609	Stainless Steel	500 psi (34bar) BPR Assemblies	ea
U-610	Stainless Steel	750 psi (52bar) BPR Assemblies	ea
P-790	PEEK	5 psi (0.3bar) BPR Assemblies	ea
P-791	PEEK	20 psi (1.4bar) BPR Assemblies	ea
P-785	PEEK	40 psi (2.8bar) BPR Assemblies	ea
P-786	PEEK	75 psi (5.2bar) BPR Assemblies	ea
P-787	PEEK	100 psi (7bar) BPR Assemblies	ea
P-788	PEEK	250 psi (17bar) BPR Assemblies	ea
P-789	PEEK	500 psi (34bar) BPR Assemblies	ea
P-455	PEEK	1,000 psi (69bar) BPR Assemblies	ea

BPR Cartridges

Part No.	End-Cap Color	Description	Qty
P-761	Blue	40 psi (2.8 bar) BPR Cartridge	ea
P-762	Yellow	75 psi (5.2 bar) BPR Cartridge	ea
P-763	Red	100 psi (7 bar) BPR Cartridge	ea
P-764	White	250 psi (17 bar) BPR Cartridge	ea
P-765	Green	500 psi (34 bar) BPR Cartridge	ea
P-795	Blue	750 psi (52 bar) BPR Cartridge	ea
P-796	Green	1,000 psi (69 bar) BPR Cartridge	ea

Micro-Splitter Valve

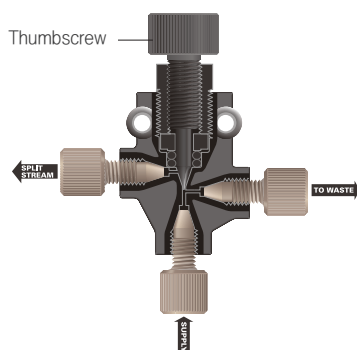

Feature

- 공급되는 액체 중 일부를 버려지게 함으로써 목적하는 적은 양만 공급 가능 (Thumbscrew로 조절)
- Thumbscrew가 많이 내려갈수록 버려지는 양 적음
- LC/MS 시스템에 주로 사용

Part No.	Description	Internal Volume ¹ (closed/fully open)	Max. Pressure	Qty
P-450	Standard, 1/4-28, Biocompatible	2.1 / 4.1 µl	800 psi (55 bar)	ea
P-451	Standard, 10-32, Biocompatible	1.2 / 2.8 µl	800 psi (55 bar)	ea
P-460S	High Pressure, 10-32, with Stainless Steel Needle	1.2 / 2.8 µl	4,000 psi (276 bar)	ea
P-470	High Pressure Graduated, 10-32, with Stainless Steel Needle	1.2 / 2.8 µl	4,000 psi (276 bar)	ea

¹ The supply and waste port thru-holes have IDs of 0.020" (0.50 mm).

The ID for the split-stream port thru-hole is 0.020" (0.50 mm) in standard versions; in capillary versions it is 0.010" (0.25 mm).

SILICATIPS™ Nanospray Emitter

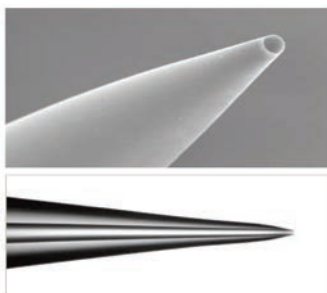

Feature

- 20 – 1,000 nL/min Flow Rate 내의 LC/MS에서 사용
- 높은 내구성 및 견고성
- 유량에 대한 다양한 ID 및 Tip 크기 선택 가능
- 다중 코팅 옵션
- Uncoated SilicaTip Emitters – N
- Distal Coated SilicaTip Emitters – D
- Standard Coated SilicaTip Emitters – CE

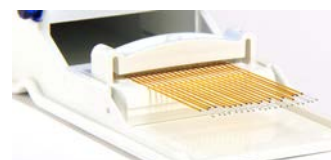

SILICATIPS™

5 cm long; specify coating desired by replacing the ## in the order number with the coating option; e.g., FS360-100-30-CE-20

Tubing OD/ID (µm)	Tip ID (µm)	Flow Range (nL/min)	Qty	Part No.
360/100	30	300-1,000	20	FS360-100-30-##-20
360/100	30	300-1,000	5	FS360-100-30-##-5
360/75	30	300-1,000	20	FS360-75-30-##-20
360/75	30	300-1,000	5	FS360-75-30-##-5
360/75	15	200-500	20	FS360-75-15-##-20
360/75	15	200-500	5	FS360-75-15-##-5
360/75	8	50-300	20	FS360-75-8-##-20
360/75	8	50-300	5	FS360-75-8-##-5
360/50	30	300-1,000	20	FS360-50-30-##-20
360/50	30	300-1,000	5	FS360-50-30-##-5
360/50	15	150-400	20	FS360-50-15-##-20
360/50	15	150-400	5	FS360-50-15-##-5
360/50	8	50-300	20	FS360-50-8-##-20
360/50	8	50-300	5	FS360-50-8-##-5
360/50	5	30-200	20	FS360-50-5-##-20
360/50	5	30-200	5	FS360-50-5-##-5
360/20	10	100-400	20	FS360-20-10-##-20
360/20	10	100-400	5	FS360-20-10-##-5
360/20	5	20-100	20	FS360-20-5-##-20
360/20	5	20-100	5	FS360-20-5-##-5
150/20	10	100-400	20	FS150-20-10-##-20
150/20	10	100-400	5	FS150-20-10-##-5

Assortment Kits : Each contains three FS360-20-5, three FS360-50-8, and three FS360-75-15

SilicaKit-360-##

Coating Options

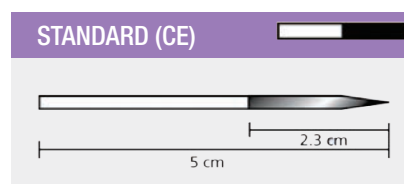
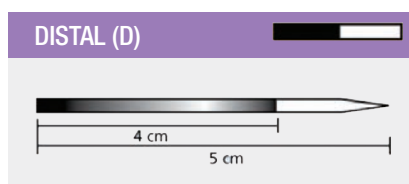
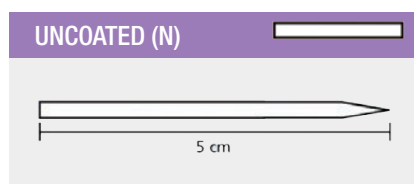

GC Septum (GC/MS)



Feature

- GC / MS용에 적합
- 고온에서도 높은 안정성
- 온도 범위 : 100–350 °C
- 고순도를 위한 유리 용기 포장

Part No.	Description	Pk
TR-D030100	diskobolus hsa 11 mm D. (7/16")	50
TR-D030200	diskobolus hsa 17 mm D.	50

GC Septum (Economy)



Feature

- 일반적 GC분석에 사용 가능한 경제적인 제품
- 온도 범위 : 200–250 °C
- 실리콘 재질
- 고순도를 위한 유리 용기 포장

Part No.	Description	Pk
TR-D033070	diskobolus Blue 6.4 mm D. (1/4")	100
TR-D033072	diskobolus Blue 9.5 mm D. (3/8")	100
TR-D033074	diskobolus Blue 11 mm D. (7/16")	100
TR-D033076	diskobolus Blue 12.7 mm. D. (1/2")	100

GC Septum (Auto-sampler)



Feature

- 오토 샘플러에 적합
- 매우 낮은 bleed
- 타 제품보다 긴 수명 (200회 이상의 인젝션 가능)
- 350°C 이상 고온에서도 높은 안정성
- 고순도를 위한 유리 용기 포장

Part No.	Description	Pk
TR-D030500	diskobolus as 9.5 mm D. (3/8")	50
TR-D030600	diskobolus as 11 mm D. (7/16")	50

GC Septum (Premium)



Feature

- 온도 범위 확장, Low bleed
- 최대 온도 400°C
- 주입구 고착이 거의 없음
- 오염을 방지하기 위해 유리 용기 포장
- 각 GC-FID 테스트 된 배치
- "Mass Spec" Capillary column과 함께 사용하기에 이상적

Part No.	Description	Pk
TR-D033000	diskobolus BTO 5 mm D. CAD*	50
TR-D033002	diskobolus BTO 6.4 mm D. (1/4")	50
TR-D033004	diskobolus BTO 9 mm D. CAD*	50
TR-D033006	diskobolus BTO 9.5 mm. D. (3/8")	50
TR-D033008	diskobolus BTO 10 mm. D.	50
TR-D033010	diskobolus BTO 11 mm. D. (7/16") CAD*	50
TR-D033012	diskobolus BTO 11 mm. D. (7/16") CAD*	100
TR-D033014	diskobolus BTO 11.5 mm. D. CAD*	50
TR-D033016	diskobolus BTO 12.7 mm. D. (1/2") CAD*	50
TR-D033018	diskobolus BTO 17 mm. D. CAD*	50
TR-D033020	diskobolus BTO "Plug", for Shimadzu	50

* CAD "Center Alignment Depression"

GC Septum (Premium, Green)



Feature

- 수명이 긴 고온용 셉타
- 높은 사용 횟수
- 주입구 고착이 거의 없음
- 최대 온도 400°C

Part No.	Description	Pk
TR-D033030	diskobolus Green 5 mm D. CAD*	50
TR-D033032	diskobolus Green 9 mm D. CAD*	50
TR-D033034	diskobolus Green 9.5 mm D. (3/8")	50
TR-D033036	diskobolus Green 11 mm. D. (7/16") CAD*	50
TR-D033038	diskobolus Green 11 mm. D. (7/16") CAD*	100
TR-D033040	diskobolus Green 11.5 mm. D. CAD*	50
TR-D033042	diskobolus Green 12.7 mm. D. (1/2") CAD*	50
TR-D033044	diskobolus Green 17 mm. D.	50
TR-D033046	diskobolus Green "Plug", for Shimadzu	50

* CAD "Center Alignment Depression"

GC Ferrule (Graphite)



Feature

- FID 및 NPD 인터페이스 어플리케이션에 적합
- Capillary column에 일반적으로 사용
- 고온에서 사용 가능
- Fused silica 및 Glass column을 완벽하게 Sealing
- 최대 450°C 까지 사용 가능

Graphite ferrules, (short ferrules) for Agilent 4890, 5890, 6890 except for GC/MS



Part No.	Description	For Capillary Column	Pk
TR-T031001	teide 1/16" to 0.4 mm	0.18 mm I.D.	10
TR-T031000	teide 1/16" to 0.5 mm	0.25-0.32 mm I.D.	10
TR-T031010	teide 1/16" to 0.8 mm	0.53 mm I.D.	10
TR-T031012	teide 1/16" to 1.0 mm	0.53-0.65 mm I.D.	10
TR-T031014	teide 1/16" to 1/16"	1/16" O.D.	10

Graphite reducing ferrules



Part No.	Description	For Capillary Column	Pk
TR-T031104	teide 1/8" to 0.4 mm	0.25 mm I.D.	10
TR-T031106	teide 1/8" to 0.5 mm	0.32 mm I.D.	10
TR-T031108	teide 1/8" to 0.8 mm	0.53 mm I.D.	10
TR-T031110	teide 1/8" to 1/16"	1/16" O.D.	10
TR-T031112	teide 1/4" to 0.5 mm	0.32 mm I.D.	10
TR-T031116	teide 1/4" to 0.8 mm	0.53 mm I.D.	10
TR-T031118	teide 1/4" to 4 mm	4 mm O.D.	10
TR-T031120	teide 1/4" to 6 mm	6 mm O.D.	10
TR-T031122	teide 1/4" to 1/16"	1/16" O.D.	10
TR-T031124	teide 1/4" to 1/8"	1/8" O.D.	10
TR-T031126	teide 1/8" two holes 0.5/0.5 mm	0.32 mm I.D.	10

Graphite standard ferrules



Part No.	Description	For Capillary Column	Pk
TR-T031020	teide 1/16" to 0.4 mm	0.25 mm I.D.	10
TR-T031030	teide 1/16" to 0.5 mm	0.32 mm I.D.	10
TR-T031040	teide 1/16" to 0.8 mm	0.53 mm I.D.	10
TR-T031042	teide 1/16" to 1.0 mm	0.65 mm I.D.	10

Special graphite ferrules for Shimadzu



Part No.	Description	For Capillary Column	Pk
TR-T031128	teide 5 mm for Shimadzu	5 mm O.D.	10

Graphite standard ferrules (two holes)

Part No.	Description	For Capillary Column	Pk
TR-T031100	teide 1/16" 2 holes, 0.4/0.4	0.25 mm I.D.	10
TR-T031102	teide 1/16" 2 holes, 0.5/0.5	0.32 mm I.D.	10



Special graphite ferrules for ThermoFinnigan M4 Nut and M8 Nut

Part No.	Description	Pk
TR-T031130	teide 0.5 mm ID (M8 nut) for ThermoFinnigan (CE)	10
TR-T031132	teide 0.8 mm ID (M8 nut) for ThermoFinnigan (CE)	10
TR-T031134	teide Cup Ferrule for Thermo 0.25 mm I.D. (M4 nut)	10
TR-T031136	teide Cup Ferrule for Thermo 0.35 mm I.D. (M4 nut)	10
TR-T031138	teide Cup Ferrule for Thermo 0.45 mm I.D. (M4 nut)	10
TR-T031140	teide Cup Ferrule for Thermo 0.80 mm I.D. (M4 nut)	10

GC Ferrule (Vespel / Graphite)

Feature

- GC / MS 검출기에 권장되는 Ferrule
- Capillary column에 일반적으로 사용하기에 적합
- 완벽한 Sealing
- 견고하며 수명이 긴 제품
- 재사용 가능
- 최대 사용온도 400°C

Teide™ Vespel/Graphite reducing ferrules Two Holes

Part No.	Description	For Capillary Column	Pk
TR-T031166	teide 1/8", two holes 0.5/0.5 mm	0.32 mm I.D.	10
TR-T031168	teide 1/8", two holes 0.8/0.8 mm	0.53 mm I.D.	10

Vespel / Graphite Ferrule

Feature

- 100% polyamide 제품
- 등은 어플리케이션에 이상적



Vespel/Graphite ferrules, (short ferrules)
for Agilent 4890, 5890, 6890

Part No.	Description	For Capillary Column	Pk
TR-T031060	teide 1/16" to 0.3 mm	0.10 mm I.D.	10
TR-T031070	teide 1/16" to 0.4 mm	0.25 mm I.D.	10
TR-T031080	teide 1/16" to 0.5 mm	0.32 mm I.D.	10
TR-T031090	teide 1/16" to 0.8 mm	0.53 mm I.D.	10

- 여러 컬럼 변경시 재사용 가능
- 최대 사용 온도 350°C

Vespel ferrules, (short ferrules) for Agilent 4890, 5890, 6890

Part No.	Description	For Capillary Column	Pk
TR-T031166	teide 1/8", two holes 0.5/0.5 mm	0.32 mm I.D.	10
TR-T031168	teide 1/8", two holes 0.8/0.8 mm	0.53 mm I.D.	10

Vespel/Graphite standard ferrules



Part No.	Description	For Capillary Column	Pk
TR-T032000	teide 1/16" to 0.4 mm	0.25 mm I.D.	10
TR-T032010	teide 1/16" to 0.5 mm	0.32 mm I.D.	10
TR-T032020	teide 1/16" to 0.8 mm	0.53 mm I.D.	10
TR-T032022	teide 1/16" to 1.0 mm	0.65 mm I.D.	10

Vespel standard ferrules

Part No.	Description	For Capillary Column	Pk
TR-T031216	teide 1/16" to 0.3 mm	0.10-0.18 mm I.D.	10
TR-T031218	teide 1/16" to 0.4 mm	0.25 mm I.D.	10
TR-T031220	teide 1/16" to 0.5 mm	0.32 mm I.D.	10
TR-T031222	teide 1/16" to 0.8 mm	0.53 mm I.D.	10
TR-T031224	teide 1/16" to 1.0 mm	0.65 mm I.D.	10
TR-T031226	teide 1/16" 2- holes 0.4/0.4 mm	0.25 mm I.D.	10
TR-T031228	teide 1/16" 2- holes 0.5/0.5 mm	0.32 mm I.D.	10

Vespel/Graphite standard ferrules (two holes)

Part No.	Description	For Capillary Column	Pk
TR-T031150	teide 1/16" 2 holes, 0.4/0.4	0.25 mm I.D.	10
TR-T031152	teide 1/16" 2 holes, 0.5/0.5	0.32 mm I.D.	10

Vespel/Graphite reducing ferrules



Part No.	Description	For Capillary Column	Pk
TR-T031160	teide 1/8" to 0.4 mm	0.25 mm I.D.	10
TR-T031162	teide 1/8" to 0.5 mm	0.32 mm I.D.	10
TR-T031164	teide 1/8" to 0.8 mm	0.53 mm I.D.	10
TR-T031170	teide 1/8" to 1/16"	1/16" O.D.	10
TR-T031172	teide 1/4" to 0.4 mm	0.25 mm I.D.	10
TR-T031174	teide 1/4" to 0.5 mm	0.32 mm I.D.	10
TR-T031176	1/4" to 0.8 mm	0.53 mm I.D.	10
TR-T031178	1/4" to 1/16"	1/16" O.D.	10
TR-T031180	1/4" to 6 mm	6 mm O.D.	10
TR-T031182	1/4" to 1/8"	1/8" O.D.	10

Vespel reducing ferrules

Part No.	Description	For Capillary Column	Pk
TR-T031232	teide 1/8" to 0.4 mm	0.25 mm I.D.	10
TR-T031234	teide 1/8" to 0.5 mm	0.32 mm I.D.	10
TR-T031236	teide 1/8" to 0.8 mm	0.53 mm I.D.	10
TR-T031238	teide 1/8" 2-hole 0.5/0.5 mm	0.32 mm I.D.	10
TR-T031239	teide 1/8" 2-hole 0.8/0.8 mm	0.53 mm I.D.	10
TR-T031242	teide 1/8" to 1/16"	1/16" O.D.	10
TR-T031244	teide 1/4" to 1/16"	1/16" O.D.	10
TR-T031246	teide 1/4" to 1/8"	1/8" O.D.	10

GC Ferrule (Straight Type)



Graphite Straight Ferrules

Part No.	Description	Pk
TR-T031157	teide Straight ferrule for tube 1/16" O.D.	10
TR-T031158	teide Straight ferrule for tube 1/8" O.D.	10
TR-T031159	teide Straight ferrule for tube 1/4" O.D.	10



Vespel/Graphite Straight Ferrules

Part No.	Description	Pk
TR-T031190	teide Straight ferrule for tube 1/16" O.D.	10
TR-T031192	teide Straight ferrule for tube 1/8" O.D.	10
TR-T031194	teide Straight ferrule for tube 1/4" O.D.	10



Vespel Straight Ferrules

Part No.	Description	Pk
TR-T031280	teide Straight ferrule for tube 1/16" O.D.	10
TR-T031282	teide Straight ferrule for tube 1/8" O.D.	10
TR-T031284	teide Straight ferrule for tube 1/4" O.D.	10



PTFE Straight Ferrules

Part No.	Description	Pk
TR-T031250	teide Straight ferrule for tube 1/16" O.D.	10
TR-T031260	teide Straight ferrule for tube 1/8" O.D.	10
TR-T031270	teide Straight ferrule for tube 1/4" O.D.	10

Gas Filter (Moisture Trap)



Feature

- PVC재질 (1회용), Cast Acrylic (충진제 교체 가능) 재질로 구성
- 1/4", 1/8" Fitting 사용 가능
- 충진제 : 13X Molecular Sieve and Indicating Drierite
- 허용 압력 : 125 psi (8bar)
- 허용 온도 : 100°C
- 유량 : 5 L/min

Model	Disposable Filter		Refillable Filter	
	DGF-125	DGF-250	RGF-125-200	RGF-250-200
Part No.	DGF-125	DGF-250	RGF-125-200	RGF-250-200
Body	Clear PVC		Cast Acrylic	
Cap	White PVC		Aluminum	
Fitting	1/8"	1/4"	1/8"	1/4"
Fill Material	13X Molecular Sieve + Indicating Drierite®			
Volume	200 ml			
Length	7 1/2"			
Diameter	2"			
Operating Pressure (Max.)	125 psi			
Operating Temperature (Max.)	100°C			
Flow rate	5 L/min			

Gas Purifier (Oxygen Trap)



Feature

- Aluminum 재질 (1회용 및 충진제 교체 가능) 재질로 구성
- 1/4", 1/8" Fitting 사용 가능
- 충진제 : Q5 + 13X Molecular Sieve Beads
- 허용 압력 : 125 psi (8.5 bar)
- 허용 온도 : 100°C
- 유량 : 5 L/min
- 수분 제거 후 Oxygen 농도 : 1 ppm

Model	Disposable Purifier		Refillable Purifier	
	DGP-125-R1	DGP-250-R1	RGF-125-R1	RGF-250-R1
Part No.	DGP-125-R1	DGP-250-R1	RGF-125-R1	RGF-250-R1
Body	Polished Aluminum		Black colored Aluminum	
Fitting	1/8"	1/4"	1/8"	1/4"
Fill Material	13X Molecular Sieve + Q5			
Fill Volume	120 ml		200 ml	
Length	5 1/2"		8"	
Diameter	2"			
Operating Pressure (Max.)	125 psi			
Operating Temperature (Max.)	100°C			
Operating Flow rate	5~9 L/min		7~14 L/min	
Oxygen Concentration (outlet)	1ppm			

SETonic Microsyringe

Technical Syringe Information

Gauge Type

23s–26s Dual Gauge Tapered Needle

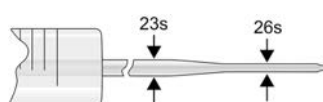

- Split/splitless or on-column injections
- Versatility without sacrificing durability
- More solid needle than regular 26s
- Minimizes septum abrasion

23s Gauge Needle



- Most durable needle
- Merlin MicroSeal™ and standard septum injections
- Packed column injections
- Split/splitless injections

26s Gauge Needle



- Fine gauge offers versatility
- On-column injections
- Split/splitless injections

Gauge Index Table

Gauge	Nominal OD mm*	Nominal ID mm*	Wall Thickness mm*	Volume µl/Inch
26s	0.474	0.127	0.35	0.322
26	0.464	0.260	0.20	1.349
25s	0.515	0.153	0.36	0.464
25	0.515	0.260	0.25	1.349
24	0.566	0.311	0.25	1.930
23s	0.642	0.116	0.53	0.268
23	0.642	0.337	0.30	2.266
22s	0.718	0.168	0.55	0.563
22	0.718	0.413	0.30	3.403
21	0.819	0.514	0.30	5.271
20	0.908	0.603	0.30	7.255
19	1.067	0.686	0.38	9.389

*mm are nominal

Plunger Tips

- PE-HD – with better durability than virgin PTFE, when working with saline solutions
- PTFE – gas-tight sealing of the plunger tip, for most solvents and chemicals
- PTFE NUB – PTFE compound with highest durability and chemical resistant combined with low electrostatic effects
- SS-Gold coated* – Gold coated stainless steel, developed for use with aggressive solvents (e.g. strong acids)

*regular stainless steel plunger syringes are available as gold coated version on request

Syringe Terminations

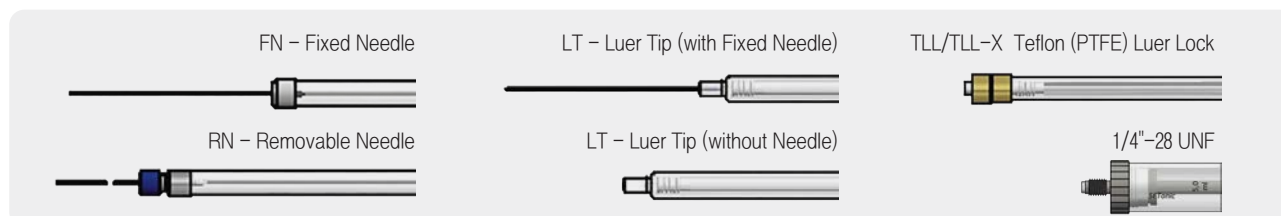

Needle Tip Styles

Type	Diagram	Description	SGE	Hamilton
Type AS and c		Special conical needle recommended for septum penetration (Autosampler Type)	1	AS
Type a		Beveled needle is recommended for life science applications	2	4
Type b		Blunt needle for use with HPLC-Injection valves and for sample pipetting	3	3
Type d		Conical needle with side port is recommended for penetration of septa, thin-gauged vinyls and plastics without coring (Headspace GC)	5	5

Agilent GC Autosampler – Removable Needle

Microsyringes 0.5 µl-10 µl - Needle Tip Style AS, Needle Length 42mm

Part No.	Volume	Plunger Type	Needle	OD (Gauge)	Qty	Agilent	ILS
3030151	0.5 µl	SS (In Needle)	RN	0.64mm (G23s)	ea	5188-5246	2204052
3030152	1 µl	SS (In Needle)	RN	0.64mm (G23s)	ea	5188-5247	2204103
3030129	5 µl	SS	RN	0.47mm (G26s)	ea	5182-0834	2104307
3030130	5 µl	SS	RN	0.64-0.47mm (G23s-G26s)	ea	5182-0835	2104308
3030138	10 µl	SS	RN	0.64mm (G23s)	ea	5181-8806	2104409
3030137	10 µl	SS	RN	0.64-0.47mm (G23s-G26s)	ea	5181-3321	2104408
3030166	10 µl	PTFE	RN	0.64mm (G23s)	ea	5181-8813	2604409
3030165	10 µl	PTFE	RN	0.64-0.47mm (G23s-G26s)	ea	5181-3356	2604408

Agilent GC Autosampler – Fixed Needle

Microsyringes 5 µl-100 µl - Needle Tip Style AS, Needle Length 42mm

Part No.	Volume	Plunger Type	Needle	OD (Gauge)	Qty	Agilent	ILS
3030128	5 µl	SS	FN	0.64mm (G23s)	ea	9301-0892	2104305
3030133	5 µl	SS	FN	0.64mm (G23s)	6/pk	5182-0875	2104315
3030127	5 µl	SS	FN	0.64-0.47mm (G23s-G26s)	ea	5181-1273	2104304
3030132	5 µl	SS	FN	0.64-0.47mm (G23s-G26s)	6/pk	5181-8810	2104314
3030126	5 µl	SS	FN	0.47mm (G26s)	ea	9301-0891	2104303
3030131	5 µl	SS	FN	0.47mm (G26s)	6/pk	5183-4728	2104313
3030136	10 µl	SS	FN	0.64mm (G23s)	ea	9301-0713	2104405
3030141	10 µl	SS	FN	0.64mm (G23s)	6/pk	9301-0725	2104415
3030135	10 µl	SS	FN	0.64-0.47mm (G23s-G26s)	ea	5181-1267	2104404
3030140	10 µl	SS	FN	0.64-0.47mm (G23s-G26s)	6/pk	5181-3360	2104414
3030134	10 µl	SS	FN	0.47mm (G26s)	ea	9301-0714	2104403
3030139	10 µl	SS	FN	0.47mm (G26s)	6/pk	5183-4729	2104413
3030163	10 µl	PTFE	FN	0.64mm (G23s)	ea	5181-8809	2604403
3030167	10 µl	PTFE	FN	0.64mm (G23s)	6/pk	5183-4730	2604413
3030164	10 µl	PTFE	FN	0.64-0.47mm (G23s-G26s)	ea	5181-3354	2604404
3030168	10 µl	PTFE	FN	0.64-0.47mm (G23s-G26s)	6/pk	5181-3361	2604414
3030169	25 µl	PTFE	FN	0.64mm (G23s)	ea	5183-0316	2604505
3030174	25 µl	PTFE	FN	0.64-0.47mm (G23s-G26s)	ea	5183-0316	2604504
3030170	50 µl	PTFE	FN	0.64mm (G23s)	ea	5183-0318	2604605
3030175	50 µl	PTFE	FN	0.64-0.47mm (G23s-G26s)	ea	5183-0314	2604604
3030171	100 µl	PTFE	FN	0.64mm (G23s)	ea	5183-2058	2604705
3030176	100 µl	PTFE	FN	0.64-0.47mm (G23s-G26s)	ea	5183-2058	2604704

CTC PALxT LC Autosampler



Syringes 10 µl-5.0 ml - Needle Tip Style b, Needle Length 51mm - Type LC

Part No.	Volume	Plunger Type	Needle	OD (Gauge)	Qty	Hamilton	SGE
LMK.2106424	10 µl	SS	FN	0.72mm (G22s)	ea	80365	002710
LMK.2606416	10 µl	PTFE	FN	0.72mm (G22s) with stop	ea	203194	002715
LMK.2620517	25 µl	PTFE	FN	0.72mm (G22s)	ea	203274	009384
LMK.2620517-2P	25 µl	PTFE	FN	0.72mm (G22s)	2/pk	203274	009384
LMK.2620517-6P	25 µl	PTFE	FN	0.72mm (G22s)	6/pk	203274	009384
LMK.2620615	50 µl	PTFE	FN	0.72mm (G22)	ea		003715
LMK.2620615-2P	50 µl	PTFE	FN	0.72mm (G22)	2/pk		
LMK.2620615-6P	50 µl	PTFE	FN	0.72mm (G22)	6/pk		004810
LMK.2620719	100 µl	PTFE	FN	0.72mm (G22s)	ea	203077	005715
LMK.2620719-2P	100 µl	PTFE	FN	0.72mm (G22s)	2/pk	203077	005715
LMK.2620719-6P	100 µl	PTFE	FN	0.72mm (G22s)	6/pk	203077	005715
LMK.2620721	100 µl	PTFE	FN	0.72mm (G22)	ea	203235	005720
LMK.2620721-2P	100 µl	PTFE	FN	0.72mm (G22)	2/pk	203235	005720
LMK.2620721-6P	100 µl	PTFE	FN	0.72mm (G22)	6/pk	203235	005720
LMK.2620821	250 µl	PTFE	FN	0.72mm (G22s)	ea		006330
LMK.2620908	500 µl	PTFE	FN ¹⁾	0.72mm (G22)	ea	203349	007720
LMK.2620011	1.0 ml	PTFE LT	FN ²⁾	0.72mm (G22)	ea		008120
MK.2620054	5.0 ml	PTFE LT	FN ²⁾	1.10mm (G19)	ea		008820

1) Needle Length 56mm 2) Needle Length 57mm

CTC Combi PAL GC Autosampler

Syringes 1.2 µl-500 µl - Needle Tip Style AS, Needle Length 51mm - Type GC

Part No.	Volume	Plunger Type	Needle	OD (Gauge)	Qty	Hamilton	SGE
LMK.2220001	1.2 µl	SS	FN	0.48mm (G26P)	ea	203185	000790
LMK.2220001-6P	1.2 µl	SS	FN	0.48mm (G26P)	6/pk	203185	000790
LMK.2106303	5 µl	SS	FN	0.64mm (G23s)	ea		
LMK.2106302	5 µl	SS	FN	0.47mm (G26s)	ea	203189	001980
LMK.2106403	10 µl	SS	FN	0.64mm (G23s)	ea	203361	002981
LMK.2106426	10 µl	SS	FN	0.64-0.47mm (G23s-G26s)	ea	203362	002981
LMK.2106416	10 µl	SS	FN	0.47mm (G26s)	ea	203205	002980
LMK.2106416-2P	10 µl	SS	FN	0.47mm (G26s)	2/pk	203205	002980
LMK.2106416-6P	10 µl	SS	FN	0.47mm (G26s)	6/pk	203205	002980
LMK.2606407	10 µl	PTFE	FN	0.47mm (G26s)	ea		002977
LMK.2606403	10 µl	PTFE	FN	0.64mm (G23s)	ea		002987
LMK.2620706	100 µl	PTFE	FN	0.47mm (G26s)	ea	203076	005700
LMK.2620706-2P	100 µl	PTFE	FN	0.47mm (G26s)	2/pk	203076	005700
LMK.2620706-6P	100 µl	PTFE	FN	0.47mm (G26s)	6/pk	203076	005700
LMK.2620803	250 µl	PTFE	FN	0.47mm (G26)	ea	203078	006700
LMK.2620903	500 µl	PTFE	FN	0.47mm (G26)	ea	203080	007700

CTC PAL 3/RTC/RSH GC & LC Autosampler



Syringes 10 µl-1.0 ml - Needle Tip Style AS, Needle Length 57mm - Type GC

Part No.	Volume	Plunger Type	Needle	OD (Gauge)	Qty	Hamilton	SGE
LMK.2116405	10 µl	SS	FN	0.64mm (G23s)	ea	207803	002865
LMK.2116404	10 µl	SS	FN	0.47mm (G26s)	ea	207807	002865
LMK.2116406	10 µl	SS	FN ¹⁾	0.47mm (G26s)	ea		002867
LMK.2616405	10 µl	PTFE	FN	0.64mm (G23s)	ea		002862
LMK.2616404	10 µl	PTFE	FN	0.47mm (G26s)	ea		
LMK.2616703	100 µl	PTFE	FN	0.47mm (G26s)	ea	207840	005866
LMK.2616803	250 µl	PTFE	FN	0.47mm (G26s)	ea		006862
LMK.2616804	250 µl	PTFE	FN ¹⁾	0.47mm (G26s)	ea		006862
LMK.2616003	1.0 ml	PTFE	FN	0.64mm (G23s)	ea	207849	

1) Needle Length 85mm

Syringes 10 µl-1.0 ml - Needle Tip Style b, Needle Length 57mm - Type LC

Part No.	Volume	Plunger Type	Needle	OD (Gauge)	Qty	Hamilton	SGE
LMK.2616422	10 µl	PTFE	FN	0.72mm (G22s)	ea		
LMK.2616502C	25 µl	PTFE	FN	0.72mm (G22s) coated ²⁾	ea	208304	
LMK.2616702C	100 µl	PTFE	FN	0.72mm (G22s) coated ²⁾	ea	208312	
LMK.2616704C	100 µl	PTFE	FN	0.72mm (G22) coated ²⁾	ea	208311	
LMK.2616822	250 µl	PTFE	FN	0.72mm (G22s)	ea	208304	
LMK.2616922	500 µl	PTFE	FN	0.72mm (G22s)	ea		
LMK.2616012	1.0 ml	PTFE	FN	0.72mm (G22s)	ea		

2) hydrophobic, oleophobic coated syringe needle

Gas-Tight Large Volume Syringes – Fixed Needle



Syringes 1.0 ml-10.0 ml

Part No.	Volume	Needle	OD (Gauge)	Needle Length	Point Style	Qty	Hamilton	SGE	Agilent
3030249	1.0 ml	FN	0.72mm (G22)	51mm	a	ea	81317	2600000	
3030198	1.0 ml	FN	0.72mm (G22)	56mm	b	ea			
3030248	1.0 ml	FN	0.64mm (G23)	51mm	a	ea		2600003	
3030186*	1.0 ml	FN	0.64mm (G23)	51mm	d	ea	203082	2620002	
3030250	2.5 ml	FN	0.72mm (G22s)	51mm	a	ea		2600020	
3030154	2.5 ml	FN	0.72mm (G22)	51mm	a	ea			5182-9642
3030199	2.5 ml	FN	0.72mm (G22)	56mm	b	ea		2620030	
3030187*	2.5 ml	FN	0.64mm (G23)	51mm	d	ea			
3030251	5.0 ml	FN	0.72mm (G22s)	51mm	a	ea		2600040	
3030155	5.0 ml	FN	0.72mm (G22)	51mm	a	ea	81517		5182-9638
3030200	5.0 ml	FN	0.72mm (G22)	56mm	b	ea		2620056	
3030188*	5.0 ml	FN	0.64mm (G23)	56mm	d	ea		2620050	
3030252	10.0 ml	FN	0.72mm (G22s)	51mm	a	ea		2600060	
3030156	10.0 ml	FN	0.72mm (G22)	51mm	a	ea			

* High temperature syringes up to 120°C for Headspace analysis

Injection Part I Column Accessories

Autosampler Syringe

SETonic

Made in Germany

Perkin Elmer AutoSystem + Clarus Equipment



Part No.	Volume	Needle	OD (Gauge)	Needle Length	Point Style	Qty	ILS	Hamilton	SGE
3030865 ¹⁾	0.5 µl	ZDV	0.47mm (G26s)	70mm	AS	ea	2208051	86275	000475
3030608 ¹⁾	5 µl	ZDV	0.64mm (G23s)	70mm	AS	ea	2208053	86275	000478
3030491	5 µl	FN	0.47mm (G26s)	70mm	AS	ea	2108302	88040	001953
3030492	5 µl	FN	0.64mm (G23s)	70mm	AS	ea	2108303	88035	001954
3030493 ²⁾	5 µl	FN	0.47mm (G26s)	70mm	AS	ea	2608302		001955
3030494 ²⁾	5 µl	FN	0.64mm (G23s)	70mm	AS	ea	2608303		001957

1) ZDV – Zero Dead Volume – Plunger in Needle

2) Gastight, with PTFE Plunger Seal

Shimadzu AOC 14/17/20



Stainless Steel Plunger 5-10 µl

Part No.	Volume	Needle	OD (Gauge)	Needle Length	Point Style	Qty	ILS	Reference
3030406	5 µl	FN	0.47mm (G26s)	42mm	a	ea	2105301	
3030407	5 µl	FN	0.64mm (G23)	42mm	a	ea	2105302	
3030408	10 µl	FN	0.47mm (G26s)	42mm	a	ea	2105401	
3030409	10 µl	FN	0.64mm (G23)	42mm	a	ea	2105402	
3030410	5 µl	FN	0.47mm (G26s)	42mm	AS	ea	2105303	001987
3030411	5 µl	FN	0.64mm (G23)	42mm	AS	ea	2105304	001988
3030412	10 µl	FN	0.47mm (G26s)	42mm	AS	ea	2105403	
3030413	10 µl	FN	0.64mm (G23)	42mm	AS	ea	2105404	202643
3030414	5 µl	RN	0.47mm (G26s)	42mm	a	ea	2105307	
3030415	5 µl	RN	0.64mm (G23)	42mm	a	ea	2105308	
3030416	10 µl	RN	0.47mm (G26s)	42mm	a	ea	2105407	
3030417	10 µl	RN	0.64mm (G23)	42mm	a	ea	2105408	
3030418	10 µl	RN	0.47mm (G26s)	42mm	AS	ea	2105409	002897
3030419	10 µl	RN	0.64mm (G23)	42mm	AS	ea	2105410	002898

Also available as 6 Packs.

On-Column Injection



Part No.	Volume	Needle	OD (Gauge)	Needle Length	Point Style	Qty	ILS
3030143	10 µl	RN	FS 0.23 ¹⁾	100mm	b	ea	2142404
3030144	10 µl	RN	0.23 (G32)	100mm	45°	ea	2142412

1) Fused Silica Needle

Gas-Tight Syringes – Fixed Needle



Syringes 5 µl-500 µl - Needle Tip Style a*, Needle Length 51mm

Part No.	Volume	Plunger Type	Needle	OD (Gauge)	Qty	ILS	Hamilton
3030241	5µl	PTFE	FN	0.47mm (G26s)	ea	2600301	
3030242	10µl	PTFE	FN	0.47mm (G26s)	ea	2600401	80000
3030243	25µl	PTFE	FN	0.72mm (G22s)	ea	2600501	80200
3030244	50µl	PTFE	FN	0.72mm (G22s)	ea	2600601	80900
3030245	100µl	PTFE	FN	0.72mm (G22s)	ea	2600701	81000
3030246	250µl	PTFE	FN	0.72mm (G22)	ea	2600801	81100
3030247	500µl	PTFE	FN	0.72mm (G22)	ea	2600901	81217

* Also available in other pointstyles

Gas-Tight Syringes – Removable Needle



Syringes 5 µl-10.0 ml - Needle Tip Style a*, Needle Length 51mm

Part No.	Volume	Plunger Type	Needle	OD (Gauge)	Qty	ILS	Hamilton
3030544	5µl	PTFE	RN	0.47mm (G26s)	ea	2600305	
3030676	10µl	PTFE	RN	0.47mm (G26s)	ea	2100405	80030
3030604	25µl	PTFE	RN	0.72mm (G22s)	ea	2600505	80230
3030605	50µl	PTFE	RN	0.72mm (G22s)	ea	2600605	80930
3030606	100µl	PTFE	RN	0.72mm (G22s)	ea	2600705	81030
3030366	250µl	PTFE	RN	0.72mm (G22s)	ea	2600805	81130
3030607	500µl	PTFE	RN	0.72mm (G22)	ea	2600905	81230
3030368	1.0ml	PTFE	RN	0.72mm (G22)	ea	2600005	81330
3030672	2.5ml	PTFE	RN	0.72mm (G22)	ea	2600025	
3030673	5.0ml	PTFE	RN	0.72mm (G22)	ea	2600045	81530
3030674	10.0ml	PTFE	RN	0.72mm (G22)	ea	2600065	81630

* Also available in other pointstyles

Replacement Needles – Needle Tip Style a*, Needle Length 51mm

Part No.	for Syringe Volume	OD (Gauge)	Qty
3050072	5µl	0.47mm (G26s)	3/pk
3050022	10µl	0.47mm (G26s)	3/pk
3050179	25µl-10ml	0.72mm (G22)	3/pk
3050036	25µl-10ml	0.72mm (G22s)	3/pk

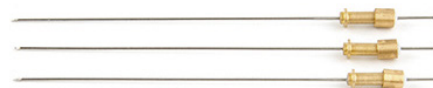

* Also available in other pointstyles





HPLC Pump & Detector Accessories



Check Valve 140

Piston Seal | Piston 148

Lamp 156



REVODIX

OPTI-MAX® Check Valve



Feature

- 발생하는 버블양을 최소화 시킨 Ball & Cartridge 구조
- 산업 표준 질소 버블 테스트에서 분당 3 버블 이하 보장 (일반적으로 허용되는 표준은 12 버블 이하)
- Tubing을 분리하지 않고 체크밸브 교체 가능한 FREE-TURN 구조
- Waters, Shimadzu, Agilent / HP 등 다양한 시스템에 사용
-  마크가 있는 제품은 FREE-TURN 구조

OPTI-MAX A UNIVERSAL SOLUTION

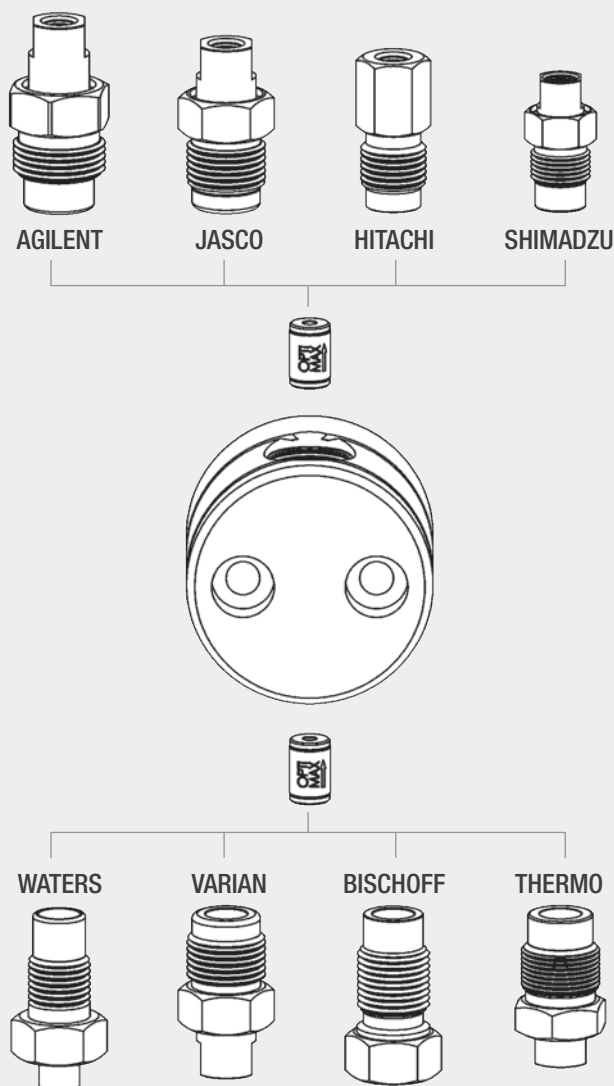

· 단일 OPTI-MAX Cartridge는 여러 펌프 브랜드간에 상호 교환 가능하며 입구 또는 출구 위치에서 작동

· 동일한 OPTI-MAX Cartridge는 Waters, Shimadzu, Agilent / HP 및 기타 여러 OEM 시스템에서 제조한 펌프의 OPTI-MAX Housing에 사용 가능

· 모듈식 Cartridge 시스템을 사용하면 체크 밸브 Cartridge 수를 최소화하고 유지 보수를 위한 재고 비용을 크게 줄일 수 있음

OPTI-MAX[®] Check Valve (For Agilent/HP)



OPTI-MAX for Agilent



AIV Replacement Cartridge



OPTI-MAX for Agilent



AIV Replacement Cartridge

Agilent/HP 1050, 1100, 1200, 1220, 1260		OEM #
27-56-01330	OPTI-MAX Outlet Housing & Cartridge	G1311-60012, G1312-60012
10-56-02004	OPTI-MAX Replacement Cartridges, 1/8" Ball, 2/pk	
27-38-04713	OPTI-MAX 600 bar AIV Replacement Cartridge	G1312-60020, 5062-8562
27-46-05033	OPTI-MAX Passive Inlet Housing & Cartridge for Agilent 1220 and 1260 only	G1312-60066
10-46-02004	OPTI-MAX Replacement Cartridges, 1/16" Ball, 2/pk	

Agilent/HP 1090		OEM #
27-38-00680	Inlet Housing & Cartridge	79835-25211
27-38-00682	Outlet Housing & Cartridge	79835-25211
27-38-00672	Replacement Cartridges, 2/pk	79835-67101

OPTI-MAX[®] Check Valve (For Beckman / Altex)



INLET



OUTLET

100A, 110A/B, 112/112M, 114/114M, 116, 118, 125, 126, 127, 128		OEM #
22-66-00516	OPTI-MAX Inlet Housing & Cartridge	240720
22-66-00520	OPTI-MAX Outlet Housing & Cartridge	240721
10-66-02005	OPTI-MAX Replacement Cartridges, 3/16" Ball, 2/pk	

HPLC Pump & Detector Accessories

Check Valve

OPTI-MAX[®] Check Valve (For Waters)



2690, 2695, 2790, 2795, Alliance* 		OEM #
39-46-01949	OPTI-MAX Inlet Housing & Cartridge	WAT027112, 700002332
10-46-02004	OPTI-MAX Replacement Cartridges, 1/16" Ball, 2/pk	WAT270941, 700002761

*2690/Alliance Systems have inlet check valves only – outlets are not required.



100 µl Head Systems  (M45/45G, M501, 510, 515, 590, 600/600E, 610, 6K/6KA, 1515, 1525, LC Module 1)		OEM #
39-56-01251	OPTI-MAX Inlet Housing & Cartridge	WAT033679, 700000253
39-56-01256	OPTI-MAX Outlet Housing & Cartridge	700000253
10-56-02004	OPTI-MAX Replacement Cartridges, 1/8" Ball, 2/Pk	700000254, 700002399



225 µl Head (#3) Systems  (510, 515, 590, 600/600E, 610, 650, 6K/6KA)		OEM #
39-66-01262	OPTI-MAX Inlet Housing & Cartridge	WAT033679, WAT060307
10-66-02005	OPTI-MAX Replacement Cartridges, 3/16" Ball, 2/pk	
39-56-01256	OPTI-MAX Outlet Housing & Cartridge	WAT025216
10-56-02004	OPTI-MAX Replacement Cartridges, 1/8" Ball, 2/pk	700000254, 700002399



400 µl (#4), 500 µl (#5), & 900 µl (#6) Heads  (Delta Prep 3000, 600/600E, 650)		OEM #
39-66-01267	OPTI-MAX Outlet Housing & Cartridge	WAT033326, WAT033325
10-66-02005	OPTI-MAX Replacement Cartridges, 3/16" Ball, 2/pk	



625/626		OEM #
39-48-01907	OPTI-MAX Inlet Housing & Cartridge, PEEK	WAT030541
39-48-01909	OPTI-MAX Outlet Housing & Cartridge, PEEK	WAT030543
10-48-02004	OPTI-MAX Replacement Cartridges, 1/16" Ball, 2/pk	WAT024120



616, 1525µ  (Micro)		OEM #
39-46-01949	OPTI-MAX Inlet Housing & Cartridge	WAT055845
39-46-01950	OPTI-MAX Outlet Housing & Cartridge	WAT055845
10-46-02004	OPTI-MAX Replacement Cartridges, 1/16" Ball, 2/pk	WAT270941, 700002761

OPTI-MAX[®] Check Valve (For Shimadzu)



LC-30		Shimadzu #
34-76-05135	OPTI-MAX Inlet Housing & Cartridge	228-52964-95
10-76-02004	OPTI-MAX Replacement Cartridges (for Inlet), 1/16" Ball, 2/pk	
34-86-05139	OPTI-MAX Outlet Housing & Cartridge	228-53334-96
10-86-02004	OPTI-MAX Replacement Cartridges (for Outlet), 1/16" Double Ball, 2/pk	



LC-30ADSF, i-Series, LC-2040/C, LC-2030/C LC-20ABXR, ADXR		Shimadzu #
34-86-02644	OPTI-MAX Inlet Housing & Cartridge	228-48249-91 228-48249-96
34-86-00893	OPTI-MAX Outlet Housing & Cartridge	228-45705-91
10-86-02004	OPTI-MAX Replacement Cartridges 1/16" Ball, 2/pk	



LC-10AT, LC-10ATVP

LC-10AT, ATVP		Shimadzu #
34-46-01983	OPTI-MAX Inlet Housing & Cartridge	228-32166-91 228-39093-92
34-46-00893	OPTI-MAX Outlet Housing & Cartridge	228-32531-92 228-34976-91
10-46-02004	OPTI-MAX Replacement Cartridges, 1/16" Ball, 2/pk	



LC-10ADVP

LC-20AB, AD, ADsp, Adnano, AT, LC-10ADVP, 2010, GPC-20 & 50 (100 µl Head), ESA 582 & 584		ESA#	Shimadzu #
34-46-02644	OPTI-MAX Inlet Housing & Cartridge	70-4056	228-39093-92 228-45704-91
34-46-00893	OPTI-MAX Outlet Housing & Cartridge	70-4057	228-34976-91 228-45705-91 228-37147-93
10-46-02004	OPTI-MAX Replacement Cartridges, 1/16" Ball, 2/pk		

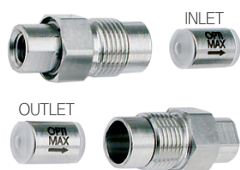

LC-10AD, LC-600, LC-9A

LC-10AD, 9A, 600 (also ESA Model 580)		ESA#	Shimadzu #
34-46-00885	OPTI-MAX Inlet Housing & Cartridge	70-0734	228-18522-91 228-33492-91
34-46-00893	OPTI-MAX Outlet Housing & Cartridge	70-0735	228-18522-92 228-32531-92
10-46-02004	OPTI-MAX Replacement Cartridges, 1/16" Ball, 2/pk		



LC-10AS, LC-6A

LC-10AS, 6A		Shimadzu #
34-56-00902	OPTI-MAX Inlet Housing & Cartridge	228-12353-91
34-56-00907	OPTI-MAX Outlet Housing & Cartridge	228-09054-93
10-56-02004	OPTI-MAX Replacement Cartridges, 1/8" Ball, 2/pk	



LC-8A

LC-20AP, 8A		Shimadzu #
34-66-02112	OPTI-MAX Inlet Housing & Cartridge	228-20256-91
10-66-02005	OPTI-MAX Replacement Cartridges (for LC-8A Inlet), 3/16" Ball, 2/pk	228-09054-93
34-56-00907	OPTI-MAX Outlet Housing & Cartridge	228-09054-93 228-50955-41
10-56-02004	OPTI-MAX Replacement Cartridges (for LC-8A Outlet), 1/8" Ball, 2/pk	

HPLC Pump & Detector Accessories

Check Valve

OPTI-MAX[®] Check Valve (For Hitachi)

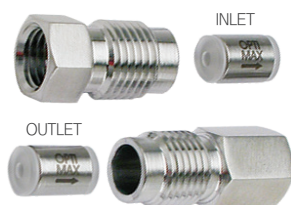

OPTI-MAX for L-7100

L-7100 (LaChrom), L-2130		OEM #
28-46-02092	OPTI-MAX Inlet Housing & Cartridge	ANO-0836, 810-1004, 809-1408
28-46-02094	OPTI-MAX Outlet Housing & Cartridge	ANO-0837, 810-1005, 809-1409
10-46-02004	OPTI-MAX Replacement Cartridges, 1/16" Ball, 2/pk	

L-2100, Smash Pump, L-2130		OEM #
28-39-02092	OPTI-MAX Inlet Housing & Cartridge	
28-39-02094	OPTI-MAX Outlet Housing & Cartridge	
10-39-02004	OPTI-MAX Check Valve Cartridge Replacement, Microbore 1/32", 2/pk	

OPTI-MAX[®] Check Valve (For Jasco)

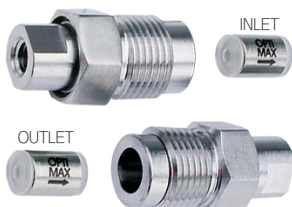

OPTI-MAX for BIP 1

BIP 1 		OEM #
42-56-01038	OPTI-MAX Inlet Housing & Cartridge	6260-H101A
42-56-01043	TI-MAX Outlet Housing & Cartridge	6260-H102A
10-56-02004	OPTI-MAX Replacement Cartridges, 1/8" Ball, 2/pk	

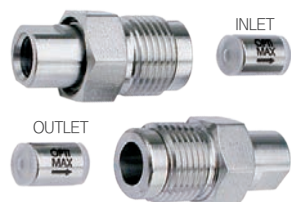

OPTI-MAX for 880/980 Series

880/980 Series 		OEM #
42-56-01544	OPTI-MAX Inlet Housing & Cartridge	6560-H405A
42-56-01546	OPTI-MAX Outlet Housing & Cartridge	6560-H404
10-56-02004	OPTI-MAX Replacement Cartridges, 1/8" Ball, 2/pk	

HPLC Pump & Detector Accessories

Check Valve

OPTI-MAX[®] Check Valve (For Perkinelmer)

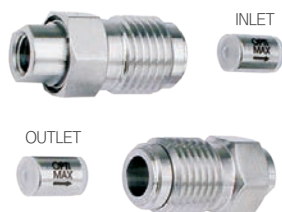

Model 250, Series 4, 200, 400,
410, 620, Integral 4000

Series 4, Model 250, 200*, 400, 410, 620, Integral 4000*		OEM #
33-56-00830	OPTI-MAX Inlet Housing & Cartridge	0254-0177
33-56-00835	OPTI-MAX Outlet Housing & Cartridge	0254-0197
10-56-02004	OPTI-MAX Replacement Cartridges, 1/8" Ball, 2/pk	

* These pumps have an intermediate check valve which is identical to the inlet check valve. To order a replacement intermediate valve, use the OPTI-MAX inlet part number.

OPTI-MAX[®] Check Valve (For Thermo : LDC / MILTON ROY)



OPTI-MAX for LDC

All Analytical (including Constametric, Minimetric, Minipump, Mini Duplex)		OEM #
31-56-00759	OPTI-MAX Inlet Housing & Cartridge	900947001
31-56-00764	OPTI-MAX Outlet Housing & Cartridge	900947002
10-56-02004	OPTI-MAX Replacement Cartridges, 1/8" Ball, 2/pk	

OPTI-MAX[®] Check Valve (For Thermo : SPECTRA-PHYSICS)

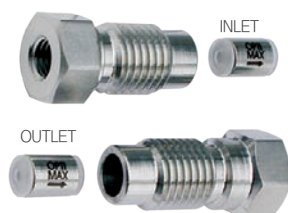

OPTI-MAX for
Spectra-Physics

8700, 8800, 8810, IsoChrom, P-Series		OEM #
35-56-00956	OPTI-MAX Inlet Housing & Cartridge	A3495-010
35-56-00961	OPTI-MAX Outlet Housing & Cartridge	A3490-010
35-56-00952	OPTI-MAX Transducer Housing & Cartridge	A3990-010
10-56-02004	OPTI-MAX Replacement Cartridges, 1/8" Ball, 2/pk	

HPLC Pump & Detector Accessories

Check Valve

OPTI-MAX[®] Check Valve (For Bischoff)

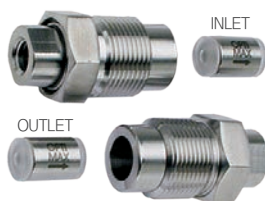

OPTI-MAX For Bischoff

Bischoff 2200, 2250, Anspec SM909, Alcott Micromeritics 760, 765 (Analytical Versions)		OEM #
24-56-00576	OPTI-MAX Inlet Housing & Cartridge	2200-0220, 760/25602/00
24-56-00581	OPTI-MAX Outlet Housing & Cartridge	2200-0230, 760/25604/00
10-56-02004	OPTI-MAX Replacement Cartridges, 1/8" Ball, 2/pk	

Bischoff 2200, Anspec SM909, Alcott Micromeritics 760 (Microbore Versions), 765		OEM #
24-46-00585	OPTI-MAX Inlet Housing & Cartridge 2200-0120,	760/25602/01
24-46-00589	OPTI-MAX Outlet Housing & Cartridge 2200-0130,	760/25604/01
10-46-02004	OPTI-MAX Replacement Cartridges, 1/16" Ball, 2/pk	

OPTI-MAX[®] Check Valve (For Dionex)

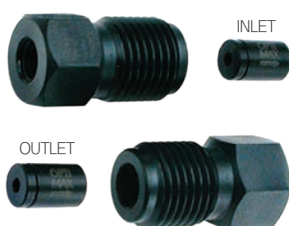

OPTI-MAX for Dionex

GP-40*/IP-20*, DQP, GPM-1, DRP, GPM-2, DXP, AGP (Analytical), 2000, 4000, GP-50/IP-25		OEM #
25-58-00613	OPTI-MAX Inlet Housing & Cartridge	047660, 38273
25-58-00612	OPTI-MAX Outlet Housing & Cartridge	047661, 42761
10-58-02004	OPTI-MAX Replacement Cartridges, 1/8" Ball, 2/pk	

OPTI-MAX[®] Check Valve (For Varian, Gilson / Rainin)

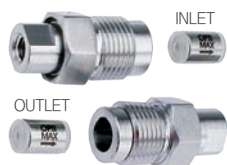

2010 for Varian

5, 10 & 25 ml S/SC Heads (Gilson, Rainin, ProStar 210/215, HP, HPX, HPXL, SD 200/300)		OEM #
26-56-00638	OPTI-MAX Inlet Housing & Cartridge	R007101616, R007101678
26-56-00647	OPTI-MAX Outlet Housing & Cartridge	R007101617, R007101679
10-56-02004	OPTI-MAX Replacement Cartridges, 1/8" Ball, 2/pk	

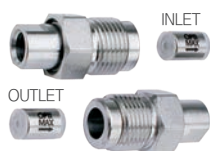

2510 for Varian

2010		OEM #
38-56-01038	OPTI-MAX Inlet Housing & Cartridge	00-997261-09
38-56-01043	OPTI-MAX Outlet Housing & Cartridge	00-997261-10
10-56-02004	OPTI-MAX Replacement Cartridges, 1/8" Ball, 2/pk	



38-38-04790 for Varian

2510		OEM #
38-56-01544	OPTI-MAX Inlet Housing & Cartridge	00-997554-19
38-56-01546	OPTI-MAX Outlet Housing & Cartridge	00-997554-18
10-56-02004	OPTI-MAX Replacement Cartridges, 1/8" Ball, 2/pk	



38-56-01067 OPTI-MAX for Varian

9000 Star, 9010, 9012, ProStar 220, 230, 240		OEM #
38-38-04790	Inlet Check Valve Assembly Includes Installation kit	03-919085-90
38-56-01067	OPTI-MAX Outlet Housing & Cartridge	03-919465-90
10-56-02004	OPTI-MAX Replacement Cartridges, 1/8" Ball, 2/pk	

OPTI-MAX[®] Check Valve (For LKB)

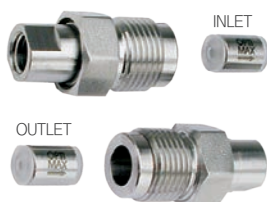

OPTI-MAX for LKB/Pharmacia

LKB 2150, 2248, 2500		OEM #
32-46-00782	OPTI-MAX Inlet Housing & Cartridge	80-1035-19
32-46-00787	OPTI-MAX Outlet Housing & Cartridge	2150-300
10-46-02004	OPTI-MAX Replacement Cartridges, 1/16" Ball, 2/pk	

Piston Seal (OPTI-SEAL)



- HPLC Pump 소모품인 Piston Seal은 3~6월 마다 교체 필요
- 내마모성이 우수하도록 특별히 설계된 OPTI-SEAL
- UHMW-PE Seal : 대부분 aqueous buffered mobile phase 사용시 선택
- PTFE-based Improved Blend (ITB) Seal : 높은 온도, 유기물 함량이 높거나 광범위한 용매 호환성이 필요한 경우 선택

Piston



- Sapphire piston 은 최적의 concentricity 및 내마모성 우수
- Sapphire rod는 특별한 커팅 기술로 내마모성이 우수하여 파손에 대한 위험이 적음
- Piston ferrule에 rod를 부착하는 것은 concentricity을 보장하는 독점 프로세스를 통해 수행됨

Seal Form Tool Kit



- Piston Seal을 손상없이 쉽게 설치 할 수 있는 Seal Forming / Insertion Tool
- Kit에는 모든 HPLC Piston Seal을 수용하는 3가지 Size의 도구가 포함되어 있음
- Kit에는 Seal 수명을 최대화 하기 위한 지침과 Seal 재질 선택을 돕는 Solvent Compatibility Guide가 포함되어 있음

Seal Forming/Insertion Tools

10-10-02695	Seal Forming/Insertion Tool Kit Includes three Forming/Insertion Tools (Small, Medium, Large), instruction booklet & Solvent Compatibility Guide
-------------	--



Forming cavities are available in three different sizes allowing the user to choose the best tool for seal installation.



The piston seal is formed by pressing the tool onto the seal jacket.



The seal is then pressed into the pump head seal cavity using the insertion support.

HPLC Pump & Detector Accessories

Piston Seal | Piston

Piston Seal & Piston (For Agilent/HP)



27-36-01570



27-36-02364



27-36-01572



27-36-02366



27-34-00658

Agilent/HP 1050, 1100		OEM #
27-36-01570	OPTI-SEAL UHMW-PE* Piston Seal	0905-1420
27-36-01571	OPTI-SEAL UHMW-PE* Piston Seal, 10/pk	
27-36-01572	ITB PTFE** Piston Seal	5063-6589
27-36-01573	ITB PTFE** Piston Seal, 10/pk	
27-36-03073	PTFE*** Pump Seal, Green, Premium Grade	
27-36-03074	PTFE*** Pump Seal, Green, Premium Grade, 10/pk	
27-36-02364	OPTI-SEAL UHMW-PE* Wash Seal	0905-1175
27-36-02365	OPTI-SEAL UHMW-PE* Wash Seal, 10/pk	
27-36-02366	ITB PTFE** Wash Seal	0905-1175
27-36-02367	ITB PTFE** Wash Seal, 10/pk	
27-36-02851	Gasket Wash Seal, 6/pk	5062-2484
27-04-02852	PTFE Frits, 5/pk	01018-22707
27-31-02853	2-in-1 Seal Cap (Replaces OEM Gold Seal - see next page for details)	5067-4728, 5062-2485
27-34-00658	Sapphire Piston	5063-6586

* UHMW-PE – Ultra High Molecular Weight Polyethylene

** ITB PTFE – Improved PTFE Blend

*** Premium grade PTFE for maximum chemical compatibility and wear resistance

Autosampler Replacement Parts (For Agilent/HP)



Autosampler
Replacement Parts



Rotor Seal
27-31-03603

Agilent/HP 1100, 1200		OEM #
27-31-03212	Rotor Seal Assembly	0100-1853
27-31-03329	Needle Seat Assembly	G1313-87101

Agilent/HP 1050		OEM #
27-31-03603	Rotor Seal	0101-0626

Agilent/HP 1090		OEM #
27-31-03649	Rotor Seal, 3 Grooves, Polyimide	7010-039
27-31-03670	Rotor Seal, 2 Grooves, Polyimide	0101-0623

Piston Seal & Piston (For Waters)



39-36-02596



39-34-02180



39-36-01305



39-36-01206



39-34-01188



39-34-01191



39-36-01216



39-36-01214



39-34-01193



39-36-02124

Alliance, 2690, 2695, 2790, 2795, 2690D, 2695D, 2796, GPC, V2000		OEM #
39-36-02596	OPTI-SEAL UHMW-PE* Piston Seal	WAT270938
39-36-02603	OPTI-SEAL UHMW-PE* Piston Seal, 2/pk	WAT270938
39-36-02597	OPTI-SEAL UHMW-PE* Piston Seal, 10/pk	
39-36-02855	Face Seals Replacement Kit, 4/pk	WAT270939
39-36-02856	Seal Wash Face Seal	WAT271017
39-36-02858	Seal Wash Tube Seals Replacement Kit, 4/pk	WAT270940
39-36-02860	Seal Wash, Piston Seal, Replacement Kit, 2/pk	WAT271018
39-34-02180	Sapphire Piston	WAT270959

100 µl Head Systems (M45/45G, M501, 510, 590, 600/600E, 610, 6K/6KA, 1515, 1525, 515, LC Module 1)		OEM #
39-36-01305	OPTI-SEAL UHMW-PE* Piston Seal	WAT022934 WAT022946
39-36-01306	OPTI-SEAL UHMW-PE* Piston Seal, 10/pk	
39-36-01206	ITB PTFE** Piston Seal, Black	WAT026613
39-36-01207	ITB PTFE** Piston Seal, Black, 10/pk	
39-34-01188	Piston, 510, 590, 600/600E, 610, 6K/6KA	WAT025656
39-34-01191	Piston, M45/45G, M501	WAT026524

225 µl Head (#3) Extended Flow Systems (510, 590, 600/600E, 610, 650, 6K/6KA, 515, 1525 EF, LC Module 1)		OEM #
39-36-01216	OPTI-SEAL UHMW-PE* Piston Seal	WAT026644 700002282
39-36-01217	OPTI-SEAL UHMW-PE* Piston Seal, 10/pk	
39-36-01214	ITB PTFE** Piston Seal	WAT026644 700002282
39-36-01215	ITB PTFE** Piston Seal, 10/pk	
39-34-01193	Piston	WAT060304

616, 625/626		OEM #
39-36-02124	OPTI-SEAL UHMW-PE* Piston Seal	
39-36-02228	OPTI-SEAL UHMW-PE* Piston Seal, 10/pk	
39-36-02127	ITB PTFE** Piston Seal	WAT031790
39-36-02229	ITB PTFE** Piston Seal, 10/pk	

* UHMW-PE – Ultra High Molecular Weight Polyethylene

** ITB PTFE – Improved PTFE Blend

Piston Seal & Piston (For Shimadzu)



34-36-00855



34-34-02645



34-36-00865



34-36-00863



34-34-01345



34-34-02650



34-36-00857

LC-20ABXR, ADXR, LC-20AB, AD, AT, LC-2010, LC-10ADV, ESA 582 & 584		ESA#	Shimadzu #
34-36-00855	OPTI-SEAL UHMW-PE* Piston Seal		228-32628-00 228-18745-00 228-35146-00
34-36-00856	OPTI-SEAL UHMW-PE* Piston Seal, 10/pk		
34-36-04711	ITB PTFE** Piston Seal		228-18745-00 228-35146-00
34-36-04712	ITB PTFE** Piston Seal, 10/pk		
34-34-02645	Sapphire Piston for LC-10ADV, 2010, 20AD (can be used for LC-10AT 228-35601-92 if user has Plunger Holder P/N 34-34-01991)	70-4052	228-35601-91 228-35601-92 228-35601-93

LC-20AT, 10AT, 10ATVP, 10AS, 7A, 6A, SIL-10ADV, GFP		Shimadzu #
34-36-00865	OPTI-SEAL UHMW-PE* Piston Seal	228-11999-00 228-21975-00 228-35145-00
34-36-00866	OPTI-SEAL UHMW-PE* Piston Seal, 10/pk	
34-36-00863	ITB PTFE** Piston Seal	228-11999-00 228-21975-00 228-35145-00
34-36-00864	ITB PTFE** Piston Seal, 10/pk	
34-34-01345	Sapphire Piston for LC-10AS	228-17019-93
34-34-02650	Sapphire Piston for LC-10ATVP	228-35009-92

Piston Wash Users : The above seals can also be used as Back Seals (OEM# 228-28499-00)

LC-10AD, 9A, 600, ESA 580		Shimadzu #
34-36-00855	OPTI-SEAL UHMW-PE* Piston Seal	228-18745-00 228-35146-00
34-36-00856	OPTI-SEAL UHMW-PE* Piston Seal, 10/pk	
34-36-00857	UHMW-PE* Elastomer Energized Seal	228-18745-00 228-35146-00
34-36-00858	UHMW-PE* Elastomer Energized Seal, 10/pk	

* UHMW-PE – Ultra High Molecular Weight Polyethylene

** ITB PTFE – Improved PTFE Blend

HPLC Pump & Detector Accessories

Piston Seal | Piston

Piston Seal & Piston (For Hitachi)



28-36-00690



28-36-00691

655, L-6000, L-6200/L-6200A, L-7100 (LaChrom), L-2100, Smash Pump		OEM #
28-36-00690	OPTI-SEAL UHMW-PE* Piston Seal	655-1080
28-36-00692	OPTI-SEAL UHMW-PE* Piston Seal, 10/pk	
28-36-00691	OPTI-SEAL UHMW-PE* Piston Seal (Hastelloy C [®] Spring)	
28-36-00693	OPTI-SEAL UHMW-PE* Piston Seal (Hastelloy C [®] Spring), 10/pk	

* UHMW-PE – Ultra High Molecular Weight Polyethylene

Piston Seal & Piston (For Jasco)



42-36-01357



42-36-01355

BIP-1, PU-2080, 2085, 2089, 1580-C02, 980, 880, 1586, 2086, 986		OEM #
42-36-01357	OPTI-SEAL UHMW-PE* Piston Seal	6560-H148, H149A
42-36-01358	OPTI-SEAL UHMW-PE* Piston Seal, 10/pk	
42-36-01355	ITB PTFE** Piston Seal	6560-H148-PE, H149A
42-36-01356	ITB PTFE** Piston Seal, 10/pk	
42-34-01354	Sapphire Piston	2305-0005A

* UHMW-PE – Ultra High Molecular Weight Polyethylene

** ITB PTFE – Improved PTFE Blend

Piston Seal & Piston (For Dionex)



25-36-00597



25-36-00599



25-36-00601

GP-40/IP-20 (Analytical), DQP, GPM-1, DRP, GPM-2, DXP, AGP (Analytical), 2000, 4000		OEM #
25-36-00597	OPTI-SEAL UHMW-PE* Piston Seal (Hastelloy C [®] Spring)	40859
25-36-00598	OPTI-SEAL UHMW-PE* Piston Seal (Hastelloy C [®] Spring), 10/pk	
25-36-00599	UHMW-PE* Piston Seal, (Elastomer O-Ring)	35686
25-36-00600	UHMW-PE* Piston Seal, (Elastomer O-Ring), 10/pk	
25-36-00601	Back-Up Seal, for all models except GP40/IP20	36901
25-36-00602	Back-Up Seal, for all models except GP40/IP20, 10/pk	

* UHMW-PE – Ultra High Molecular Weight Polyethylene

Piston Seal & Piston (For Perkinelmer)



33-34-00798

Model 200, 250, 410, 620, Integral 4000 (Mfd. After 12/89)		OEM #
33-34-00798	Piston (High Pressure)	N260-0124



33-36-01301

Series 1, 2, 3, 3B, 10, Model 200, 250, 400, 410, 620, Integral 4000		OEM #
33-36-01301	OPTI-SEAL UHMW-PE* Piston Seal (High Pressure)	0990-7324
33-36-01302	OPTI-SEAL UHMW-PE* Piston Seal (High Pressure), 10/pk	



33-36-00804

Series 4, Model 400, 410, 620, Integral 4000		OEM #
33-36-00804	OPTI-SEAL UHMW-PE* Piston Seal (Low Pressure)	0990-7330
33-36-00805	OPTI-SEAL UHMW-PE* Piston Seal (Low Pressure), 10/pk	



33-36-00806

Series 100		OEM #
33-36-00806	OPTI-SEAL UHMW-PE* Piston Seal	N260-0108
33-36-00807	OPTI-SEAL UHMW-PE* Piston Seal , 10/pk	
33-36-00808	ITB PTFE** Piston Seal	N260-0109
33-36-00809	ITB PTFE** Piston Seal, 10/pk	

* UHMW-PE – Ultra High Molecular Weight Polyethylene

** ITB PTFE – Improved PTFE Blend

Piston Seal & Piston (For Bischoff)



24-34-00559

Bischoff 2200, Anspec SM909, Alcott Micromeritics 760, 765 (Analytical Versions)		OEM #
24-34-00559	Sapphire Piston	2200-0210, 760/25803/00



24-36-00573

Bischoff 2200, Anspec SM909, Alcott Micromeritics 760 (Microbore Versions), 765		OEM #
24-36-00573	ITB PTFE** Piston Seal	2200-0112, 760/25601/01
24-36-00575	ITB PTFE** Piston Seal, 10/pk	
24-36-00574	Piston Seal Support Ring	2200-0111, 760/25603/01



24-36-00574

** ITB PTFE – Improved PTFE Blend

HPLC Pump & Detector Accessories

Piston Seal | Piston

Piston Seal & Piston (For Thermo : LDC / MILTON ROY)



All Analytical (including Constametric, Minimetric, Minipump, Mini Duplex)		OEM #
31-36-00806	OPTI-SEAL UHMW-PE* Piston Seal	206234
31-36-00807	OPTI-SEAL UHMW-PE* Piston Seal, 10/pk	
31-36-00808	ITB PTFE** Piston Seal, Black	206129001
31-36-00809	ITB PTFE** Piston Seal, Black, 10/pk	
31-36-00745	UHMW-PE* Piston Seal, Gold	206234
31-36-00746	UHMW-PE* Piston Seal, Gold, 10/pk	
31-34-00738	Sapphire Piston	801306

* UHMW-PE – Ultra High Molecular Weight Polyethylene

** ITB PTFE – Improved PTFE Blend

Piston Seal & Piston (For Thermo : SPECTRA-PHYSICS)



8800, 8810, IsoChrom, P-Series		OEM #
35-36-00930	OPTI-SEAL UHMW-PE* Piston Seal A	2962-010
35-36-00931	OPTI-SEAL UHMW-PE* Piston Seal, 10/pk	
35-36-00938	ITB PTFE** Piston Seal	A2962-010
35-36-00939	ITB PTFE** Piston Seal, 10/pk	
35-36-00916	Back-Up Seal, PCTFE	A4848-010
35-36-00917	Back-Up Seal, PCTFE, 10/pk	
35-36-00918	OPTI-SEAL UHMW-PE* Flush Seal	A2963-010
35-36-00919	OPTI-SEAL UHMW-PE* Flush Seal, 10/pk	
35-36-00920	ITB PTFE** Flush Seal	A2963-010
35-36-00921	ITB PTFE** Flush Seal, 10/pk	
35-34-00915	Sapphire Piston	A3102-010

8700, 8700XR, 8750		OEM #
35-36-00934	OPTI-SEAL UHMW-PE* Piston Seal	A1703-020
35-36-00935	OPTI-SEAL UHMW-PE* Piston Seal, 10/pk	

* UHMW-PE – Ultra High Molecular Weight Polyethylene

** ITB PTFE – Improved PTFE Blend

Piston Seal & Piston (For Varian, Gilson / Rainin)



38-36-01000

38-36-01002



38-36-01555

38-36-01553



10 ml S/SC Heads (Gilson, Rainin, HP, HPX, HPXL, SD 200/300)		OEM #
26-36-00632	OPTI-SEAL UHMW-PE* Piston Seal	5463125895, R007101447
26-36-00633	OPTI-SEAL UHMW-PE* Piston Seal, 10/pk	
26-36-00630	ITB PTFE** Piston Seal	5463125095, R007101636
26-36-00631	ITB PTFE** Piston Seal, 10/pk	

5 ml S/SC Heads (Gilson, Rainin, HP, HPX, HPXL, SD 200/300)		OEM #
26-36-00634	OPTI-SEAL UHMW-PE* Piston Seal	5463088863, R007101634
26-36-00635	OPTI-SEAL UHMW-PE* Piston Seal, 10/pk	
26-36-00636	ITB PTFE** Piston Seal	5463088063, R007101633
26-36-00637	ITB PTFE** Piston Seal, 10/pk	
26-34-00625	Piston, 5 ml SC Head	3650008, R007101657

ProStar 210/215 (10 ml Heads)		OEM #
38-36-00632	OPTI-SEAL UHMW-PE* Piston Seal	R007101447
38-36-00633	OPTI-SEAL UHMW-PE* Piston Seal, 10/pk	

ProStar 210/215 (10 ml Heads) (continued)		OEM #
38-36-00630	ITB PTFE** Piston Seal	R007101636
38-36-00631	ITB PTFE** Piston Seal, 10/Pack	

ProStar 210/215 (5 ml Heads)		OEM #
38-36-00634	OPTI-SEAL UHMW-PE* Piston Seal	R007101634
38-36-00635	OPTI-SEAL UHMW-PE* Piston Seal, 10/pk	
38-36-00636	ITB PTFE** Piston Seal	R007101633
38-36-00637	ITB PTFE** Piston Seal, 10/pk	
38-34-00625	Sapphire Piston, 5 ml Head	R007101657

2010, 2510		OEM #
38-36-01000	OPTI-SEAL UHMW-PE* Piston Seal	00-997261-37
38-36-01001	OPTI-SEAL UHMW-PE* Piston Seal, 10/pk	
38-36-01002	ITB PTFE** Piston Seal	00-997261-37
38-36-01003	ITB PTFE** Piston Seal, 10/pk	
38-34-00999	Sapphire Piston	00-997261-08

9000 Star, 9010, 9012, 9020, 220, 230, 240		OEM #
38-36-01555	OPTI-SEAL UHMW-PE* Piston Seal	03-919397-00
38-36-01556	OPTI-SEAL UHMW-PE* Piston Seal, 10/pk	
38-36-01553	ITB PTFE** Piston Seal	03-919397-00
38-36-01554	ITB PTFE** Piston Seal, 10/pk	
38-34-01342	Sapphire Piston	03-919180-00 03-919102-90

* UHMW-PE – Ultra High Molecular Weight Polyethylene

** ITB PTFE – Improved PTFE Blend

HPLC Pump & Detector Accessories

Lamp

Lamp (For Agilent/HP)



Agilent 1100 DAD
27-32-02845

Agilent/HP		OEM #
27-32-02844	Deuterium Lamp, 1050C, 1050DAD, 1090, 1040	79883-60002
27-32-02845	DoubleLife Deuterium Lamp, 1100, 1200 DAD	5181-1530, 2140-0813
27-32-02846	DoubleLife Deuterium Lamp, 1100, 1200 VWD	G1314-60100
27-32-02715	Deuterium Lamp, 1100 VWD G1314A	G1314-60100
27-32-04038	Doublelife Deuterium Lamp, 1050	79883-60002

Lamp (For Waters)

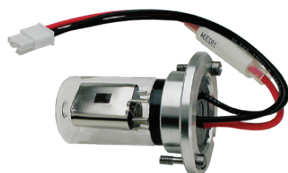

Waters
39-32-02825

Waters		OEM #
39-32-01175	Mercury Lamp, Waters 440, 441	WAT097323
39-32-01179	Deuterium Lamp, Waters 484	WAT080357
39-32-01294	Deuterium Lamp, Waters 450	WAT098946
39-32-01295	Deuterium Lamp, Waters 480, 481, 481AZ	WAT099499
39-32-02823	Deuterium Lamp, Waters 486	WAT080678
39-32-02825	ACQUITY, CapLC 2487, nanoACQUITY Deuterium Lamp, Waters 2487, 2488	WAS081142
39-32-02835	DoubleLife Deuterium Lamp, Waters 996, 2996, PDA	WAT052586
39-32-02688	Xenon Lamp, Waters 490E	WAT046660

Lamp (For Shimadzu)



Shimadzu
34-32-02837

Shimadzu		OEM #
34-32-02837	DoubleLife Deuterium Lamp, SPD-10A, -10AV, -M10A, -10AS, -10AVP, -M10AVP, -20AV	228-34016-02
34-32-03102	DoubleLife Deuterium Lamp, LC 2010, LC- 2010HT	228-37401-00

Lamp (For Jasco)



42-32-02842

Jasco		OEM #
42-32-02841	DoubleLife Deuterium Lamp, 870, 875	5330-0097
42-32-02842	DoubleLife Deuterium Lamp, UV-1570, -1575, -2070, -2075, 975 B/C Series	5330-0091

Lamp (For PerkinElmer)



33-32-03114

PerkinElmer		OEM #
33-32-03117	Deuterium Lamp, 200 UV/Vis	N292-0149
33-32-03114	DoubleLife Deuterium Lamp, Series 200 DAD	N292-2046

Lamp (For Thermo)



31-32-01295

LDC/Milton Roy		OEM #
31-32-01295	Deuterium Lamp, 3000 and 4000 Series, Spectromonitor I-II-III-D	108035
Spectra-Physics		OEM #
35-32-01333	Deuterium Lamp, Spectra-Physics Focus, 100, 200, UV-100, -150, -200, -100, 2000,3000, CE Series	9551-0023

Lamp (For Dionex)



Dionex
25-32-02081

Dionex		OEM #
25-32-02081	Deuterium Lamp, Dionex VDM-1, DSA-1	
25-32-02820	Deuterium Lamp, Dionex CES 1, VDM-2	40651

Lamp (For Varian, Gilson / Rainin)



38-32-01637

Gilson / Rainin Models		OEM #
26-32-03671	Deuterium Lamp, Gilson/Rainin 115, 116, 117, 118, 119, 151, 152, 155, 156	100326
26-32-03069	Deuterium Lamp, Gilson/Rainin 170 DAD	2140-0590
Varian Models		OEM #
38-32-01637	Deuterium Lamp, Varian 2050, 2550, 5500	
38-32-03673	Deuterium Lamp, Varian ProStar 330 DAD	0393570502
38-32-02831	DoubleLife Deuterium Lamp, Vista 5000-5500, UV-50, -100, -200, -9050	0391615691
38-32-02081	Deuterium Lamp, Varian ProStar 340, 345, U-VC, UV-DII, UV-M, UVDII, UV	R000088515
38-32-03654	DoubleLife Deuterium Lamp, Varian ProStar 325, 335	110715400
38-32-04022	Xenon Lamp, Varian ProStar	363 392613102





Pump | Degasser



Dual Piston Pump	160
Single Piston Pump	162
Degasser	163



Pump | Degasser Dual Piston Pump (High Pressure)



Made in Japan

UI-22 Series



Feature

- Linear Drive 방식으로 저맥동 이송
- 동작시 발생하는 기포 최소화
- LCD를 통한 압력 및 유량 확인
- Plunger의 부드러운 동작으로 Plunger seal의 수명 증가
- 2대 이상의 펌프를 RS-232C 통신으로 제어 가능
- PEEK, PCTFE, SUS 중 재질 선택 가능

Specification

Product name	Intelligent Pump			
Part No.	UI-22-110		UI-22-410	
Pump Head Material	SS	PEEK	SS	PCTFE
Max Pressure	35 MPa	20 MPa	5 MPa	2 MPa
Flow Rate Range	0.001 ~ 9.999 ml/min		0.01 ~ 99.99 ml/min	
Flow Per Stroke	80 μ l		708 μ l	
Plunger Stroke	10 mm			
Flow accuracy	< 0.3 %			
Features	Active Pulse Reduction, Flow Volume Calibration, Upper and Lower Pressure Limiter			
Pressure Accuracy	< 5 %			
Wetted Materials	SS Type : SS, Sapphire, Rubby, PTFE, PCTFE PEEK Type : PEEK, Sapphire, Rubby, PTFE, PCTFE PCTFE Type : PCTFE, Sapphire, Rubby, PTFE, ETFE			
Remote Control	Input : Pump On/Off, Output : Error Signal			
Communication	RS232C			
Dimensions	144 (H) x 105 (W) x 240 (D)			
Weight	Approx 5.6 kg			

Comparison of Pulsation with a Conventional Pump

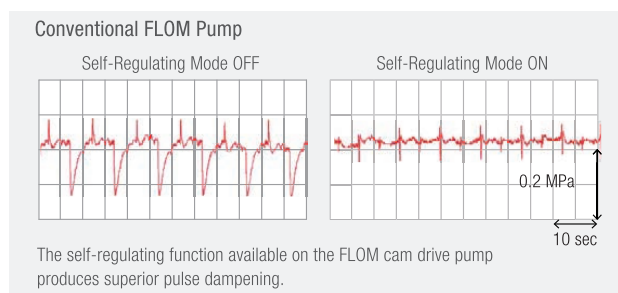
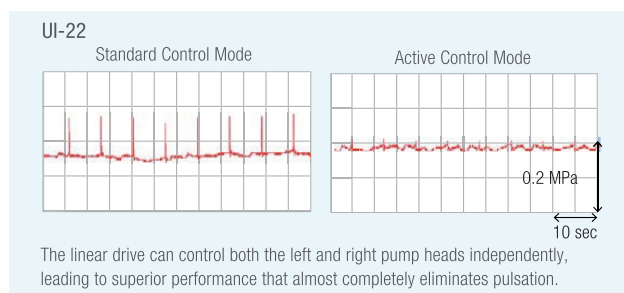

Pump | Degasser

Dual Piston Pump (High Pressure)



Made in Japan

KP-22 Series

Feature

- 압력센서가 있는 모델 (압력 모니터링)
- 높은 정밀도와 안정적인 유량
- Column 보호를 위한 Pressure limiter
- Flow mode로 원하는 유량 설정 가능
- PEEK, SUS 재질 선택 가능



Specification

Part No.	KP-22-01		KP-22-13			KP-22-33		
Pump Head Material	SS	PEEK	SS	PEEK	PCTFE	SS	PEEK	PCTFE
Max pressure	25MPa	20MPa	25MPa	20MPa	2MPa	5MPa	5MPa	2MPa
Flow rate range	0.001~1.00 mL/min		0.01~10.0 mL/min			0.1~50.0 mL/min		
Flow per stroke	4 μ l		32 μ l			154 μ l		
Flow accuracy	\pm 0.3%							
Features	Pulse control · Flow volume calibration · Upper and lower pressure limiter Constant pressure flow · Set volume dispensing							
Pressure accuracy	\pm 5 %							
Wetted material	SS type : SS, Sapphire, Ruby, PTFE, PCTFE PEEK type : PEEK, Sapphire, Ruby, PTFE, PCTFE PCTFE type: PCTFE, Sapphire, Ruby, PTFE, ETFE							
Remote control	Input: PUMP ON/OFF · Output: Error signal							
Communication	RS232C							
Dimensions (mm)	144 (H) x 79 (W) x 285 (D) mm							
Weight	SS type: 4.3 kg, PEEK and PCTFE type: 3.8 kg							
Order Code	SDP-P1081	SDP-P1080	SDP-P1077	SDP-P1076	SDP-P1114	SDP-P1079	SDP-P1078	SDP-P1111

KP-21 Series

Feature

- 압력센서가 없는 경제적인 모델
- 높은 정밀도와 안정적인 유량
- 용매에 따른 다양한 Seal 선택 가능
- PEEK, SUS 재질 선택 가능



Specification

Part No.	KP-21-01		KP-21-13		KP-21-33	
Pump Head Material	SS	PEEK	SS	PEEK	SS	PEEK
Max pressure	25MPa	20MPa	25MPa	20MPa	5MPa	5MPa
Flow rate range	0.001~1.00 mL/min		0.01~10.0 mL/min		0.1~50.0 mL/min	
Flow per stroke	4 μ l		32 μ l		154 μ l	
Flow accuracy	\pm 0.3%					
Features	Flow volume calibration · Set volume dispensing					
Pressure accuracy	\pm 5 %					
Wetted material	SS type : SS, Sapphire, Ruby, PTFE, PCTFE PEEK type : PEEK, Sapphire, Ruby, PTFE, PCTFE					
Remote control	Input: PUMP ON/OFF · Output: Error signal					
Communication	RS232C					
Dimensions (mm)	144 (H) x 79 (W) x 285 (D) mm					
Weight	Approx. 3.4 kg					
Order Code	SDP-P1087	SDP-P1086	SDP-P1083	SDP-P1082	SDP-P1085	SDP-P1084

Pump | Degasser

Single Piston Pump (High Pressure)



Made in Japan

SP-22 Series

Feature

- 최신 기술의 Single Piston Pump
- 압력센서가 있는 모델 (압력 모니터링)
- 심플한 액체 이송시 적합
- Column 보호를 위한 Pressure limiter
- PEEK, SUS 재질 선택 가능



Specification

Part No.	SP-22-02		SP-22-12		SP-22-13		SP-22-32		SP-22-33	
Pump Head Material	SS	PEEK	SS	PEEK	SS	PEEK	SS	PEEK	SS	PEEK
Max pressure	20MPa	20MPa	20MPa	20MPa	10MPa	10MPa	5MPa	5MPa	2MPa	2MPa
Flow rate range	0.01~1.00 mL/min		0.01~2.00 mL/min		0.1~5.0 mL/min		0.1~10.0 mL/min		0.1~20.0 mL/min	
Flow per stroke	8 μ l		16 μ l		32 μ l		77 μ l		154 μ l	
Stroke length	2 mm		2 mm		4 mm		2 mm		4 mm	
Flow accuracy	$\pm 0.5\%$									
Features	Pulse reduction · Flow volume calibration · Upper and lower pressure limiter Constant pressure flow · Set volume dispensing									
Pressure accuracy	$\pm 5\%$									
Wetted material	SS type : SS, Sapphire, Ruby, PTFE, PCTFE PEEK type : PEEK, Sapphire, Ruby, PTFE, PCTFE									
Remote control	Input: PUMP ON/OFF · Output: Error signal									
Communication	RS232C									
Dimensions (mm)	144(H) x 79(W) x 285(D) excluding protuberances									
Weight	approx 3.0 kg									
Order Code(PEEK)	SSP-P3062	SSP-P3061	SSP-P3064	SSP-P3063	SSP-P3066	SSP-P3065	SSP-P3068	SSP-P3067	SSP-P3070	SSP-P3069

SP-21 Series

Feature

- 경제적인 Single Piston Pump
- 압력센서가 없는 모델
- 편리하고 정밀한 Solvent volume dispensing
- PEEK, SUS 재질 선택 가능



Specification

Part No.	SP-21-02		SP-21-12		SP-21-13		SP-21-32		SP-21-33	
Pump Head Material	SS	PEEK	SS	PEEK	SS	PEEK	SS	PEEK	SS	PEEK
Max pressure	20MPa	20MPa	20MPa	20MPa	10MPa	10MPa	5MPa	5MPa	2MPa	2MPa
Flow rate range	0.01~1.00 mL/min		0.01~2.00 mL/min		0.1~5.0 mL/min		0.1~10.0 mL/min		0.1~20.0 mL/min	
Flow per stroke	8 μ l		16 μ l		32 μ l		77 μ l		154 μ l	
Stroke length	2 mm		2 mm		4 mm		2 mm		4 mm	
Flow accuracy	$\pm 0.5\%$									
Features	Pulse reduction · Set volume dispensing									
Pressure accuracy	-									
Wetted material	SS type : SS, Sapphire, Ruby, PTFE, PCTFE PEEK type : PEEK, Sapphire, Ruby, PTFE, PCTFE									
Remote control	Input: PUMP ON/OFF · Output: Error signal									
Communication	RS232C									
Dimensions (mm)	144(H) x 79(W) x 285(D) excluding protuberances									
Weight	approx 3.0 kg									
Order Code(PEEK)	SSP-P3052	SSP-P3051	SSP-P3054	SSP-P3053	SSP-P3056	SSP-P3055	SSP-P3058	SSP-P3057	SSP-P3060	SSP-P3059

Degassing System

Degassing Explained

- 용매가 일정한 진공상태가 유지되는 챔버 속에 장착된 Systec AF™ membrane tube를 지나가도록 하여 gas가 membrane tube 밖으로 배출 되고 용매만 통과하여 펌프로 공급되는 방식

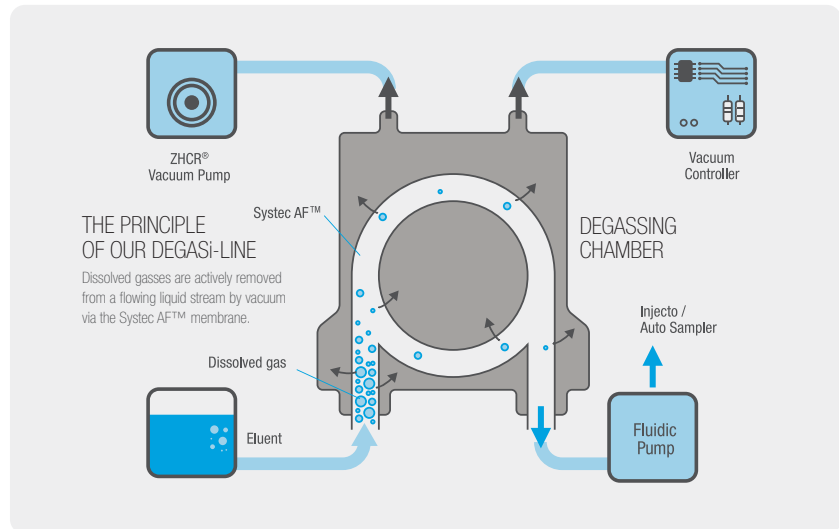

DEGASi-Line



	GENERAL PURPOSE	GPC ELUENT	LIMITED VOLUME	SEMI PREP	HI-END PREP	COMPACT APPLICATION
Systec AF™ Internal Volume	480 µl	480 µl	100 µl	925 µl	5.3 ml / 13.8 ml	285 µl
No of Channels	1-6	1-6	1-6	1-6	2	2, 4, 6
Biocompatible Flow Path	Y	N	Y	Y	Y	Y
Approximately Max Flow Per Channel (ml/min)	3	3	0.5	6	15 / 50	2
Inner Dimension Flow Path (mm)	1.14	1.14	1.14	1.14	1.91	0.89

DEGASI-CLASSIC



Feature

- 5년 이상 사용가능한 수명
- 소음이 거의 없음
- 최대 유량 : 5 mL/min
- 가장 효율적으로 degassing 할 수 있는 유량 : 3 mL/min
- 에러 및 누수 확인 기능
- CE & RoHS 기준 준수

Specification

Degassing Channel Tubing	Systec AFT™ (0.045" ID)
Degassing Channel Pressure Rating	70 PSI
Wetted Materials	Systec AFT™, PEEK, Glass-filled PTFE
Liquid Connection	1/4" -28 UNF threaded flat-bottom port
Size (L x H x B)	245 x 111 x 59 mm
Power requirement using supplied AC Adapter	110-240 V 50/60 HZ

Part No.	Number of Channels	Internal Volume
0003-6351-A	1	480 µl
0003-6352-A	2	480 µl
0003-6353-A	3	480 µl
0003-6354-A	4	480 µl
0003-6355-A	5	480 µl
0003-6356-A	6	480 µl

DEGASI-MICRO



Feature

- 매우 적은 유량과 시스템 내부의 Dead Volume의 최소화를 원할 때 추천
- 높은 투과성의 Systec AFT™ membrane 으로 Internal volume은 100 µL
- 가장 효율적으로 degassing 할 수 있는 유량 : 0.5 mL/min
- 에러 및 누수 확인 기능

Specification

Degassing Channel Tubing	Systec AFT™ (0.045" ID)
Degassing Channel Pressure Rating	70 PSI
Wetted Materials	Systec AFT™, PEEK, Glass-filled PTFE
Liquid Connection	1/4" -28 UNF threaded flat-bottom port
Size (L x H x B)	245 x 111 x 59 mm
Power requirement using supplied AC Adapter	110-240 V 50/60 HZ

Part No.	Number of Channels	Internal Volume
0003-6351-S	1	100 µl
0003-6352-S	2	100 µl
0003-6353-S	3	100 µl
0003-6354-S	4	100 µl
0003-6355-S	5	100 µl
0003-6356-S	6	100 µl

DEGASi-SEMI-PREP



Feature

- 높은 유량 사용할 경우 추천 (Up to 6-10 mL/min)
- 높은 투과성의 Systec AF™ membrane 으로 Internal volume은 925 µL
- 에러 및 누수 확인 기능

Specification

Degassing Channel Tubing	Systec AF™ (0.045" ID)
Degassing Channel Pressure Rating	70 PSI
Wetted Materials	Systec AF™, PEEK, Glass-filled PTFE
Liquid Connection	1/4"-28 UNF threaded flat-bottom port
Size (L x H x B)	245 x 111 x 59 mm
Power requirement using supplied AC Adapter	110-240 V 50/60 HZ

Part No.	Number of Channels	Internal Volume
0003-6351-L	1	925 µL
0003-6352-L	2	925 µL
0003-6353-L	3	925 µL
0003-6354-L	4	925 µL
0003-6355-L	5	925 µL
0003-6356-L	6	925 µL

DEGASi-PREP



Feature

- 각 채널당 50 mL/min 까지 사용 가능
- Preparative 와 Semi-prep 규모의 HPLC 실험에 적합
- UHPLC / HPLC의 안정적 연속동작 및 성능을 보장하는 디자인
- Low flow resistance를 위한 Dual lumen 디자인
- Systec AF™ 의 각 채널별 내부 부피가 적어 PTFE degasser와 비교하여 기동시간 (startup times)이 짧고 안정화 되는 시간이 빠름

Specification

Degassing Channel Tubing	Systec AF™ (0.075" ID)
Degassing Channel Pressure Rating	70 PSI
Wetted Materials	Systec AF™, PEEK, Glass-filled PTFE, Stainless Steel (P/N 2053)
Liquid Connection	1/4"-28 UNF threaded flat-bottom port
Size (L x H x B)	Mod 6484: 296x163x79 mm Mod 2053: 195x100x175 mm
Power requirement using supplied AC Adapter	110-240 V 50/60 HZ

Part No.	Number of Channels	Internal Volume
0001-2053	2	5.3 ml



REVODIX Lab Equipment



Chamber & Storage	168
Autoclave	172
Laboratory Safety	174
Basic Equipment	177
Food Analyzer	183
Microbiology Instrument	184
Tablet Tester	186
Measuring Instrument	187
Water Analyzer	188
Laboratory Consumables	190

REVODIX

Dry Oven | Vacuum Dry Oven | Stability Chamber

자연순환식 건조기

Dry Oven



- 용도 : 초자 및 시료건조
- 특징 : 자연대류방식으로 시료가 받는 영향 최소화

Maker	MMM (Germany)
제품명	Ecocell ECO
용량	22, 55, 111, 222, 404, 707 L
온도 범위	상온 +5 ~ 250 °C
옵션	외부 연결 포트, 300 °C
IQ/OQ	가능

자연순환식 건조기 (내화학성)

Dry Oven



- 용도 : 산성·알칼리성 유기용매 건조
- 특징 : 내부 테프론 코팅으로 내화학성을 높임

Maker	MMM (Germany)
제품명	Durocell ECO
용량	22, 55, 111, 222 L
온도 범위	상온 +5 ~ 125 °C
옵션	외부 연결 포트, 도어락
IQ/OQ	가능

강제순환식 건조기

Dry Oven



- 용도 : 초자 및 시료건조, 건열 열균
- 특징 : 나선형 공기 흡입 방식으로 온도 균일성 우수

Maker	MMM (Germany)
제품명	Venticell ECO
용량	22, 55, 111, 222, 404, 707, 1212 L
온도 범위	상온 +10 ~ 250 °C
옵션	300 °C, HEPA-Filter, 2 Door
IQ/OQ	가능

진공 감압 건조기

Vacuum Dry Oven



- 용도 : 감압 건조 감량 시험, 분진이나 고온에서 변성되는 시료 건조
- 특징 : 0.005 mbar까지의 고진공 유지

Maker	MMM (Germany)
제품명	Vacucell ECO, EVO
용량	22, 55, 111 L
온도 범위	상온 +5 ~ 200 °C
옵션	디지털 진공도 표시, Printer
IQ/OQ	가능

안정성 챔버

Stability Chamber



- 용도 : 시료의 장기 보존 및 가속·가속 시험 조건 사용 가능
- 특징 : 온습도 범위가 넓어 장기보존, 가속, 저온조건 사용가능

Maker	MMM (Germany)
제품명	Climacell ECO, EVO
용량	111, 222, 404, 707, 1212 L
온도 범위	0 ~ 100 °C
습도 범위	10 ~ 98 %
옵션	외부 연결 포트, ECO : -10°C, EVO : -20°C, 기록계, BMS 중앙모니터링

광안정성 챔버

Photostability Chamber



- 용도 : 광안정성 시험, 식물 생장상 등
- 특징 : 광 트레이 장착시 ICH Guideline Q1B에 적합한 광안정성 시험가능

Maker	MMM (Germany)
제품명	Climacell EVO (Photostability Option)
용량	111, 222, 404, 707, 1212 L
온도 범위	0 ~ 100 °C
습도 범위	10 ~ 98 %
옵션	광 트레이 (UV/VIS), CO ₂ 컨트롤, PC 저장 기능

Incubator | CO₂ Incubator | Low Temperature Incubator

자연순환식 배양기

Incubator



- 용도 : 다양한 산업군의 미생물 배양 실험
- 특징 : 자연대류 방식으로 시료가 받는 영향 최소화

Maker	MMM (Germany)
제품명	Incucell ECO
용량	22, 55, 111, 222, 404, 707, 1212 L
온도 범위	상온 +5 ~ 100 °C
옵션	외부연결 포트, 도어락, 기록계, 4 ~ 20 mA
IQ/OQ	가능

강제순환식 배양기

Incubator



- 용도 : 다양한 산업군의 미생물 배양 실험
- 특징 : 나선형 공기 흡입 방식으로 온도 균일성 우수

Maker	MMM (Germany)
제품명	Incucell V ECO
용량	22, 55, 111, 222, 404, 707, 1212 L
온도 범위	상온 +10 ~ 100 °C
옵션	외부연결 포트, HEPA-Filter, 기록계, 4 ~ 20 mA
IQ/OQ	가능

혐기성 배양기

CO₂ Incubator



- 용도 : 혐기성 배양, 바이오 (세포/조직 배양) 실험
- 특징 : IR CO₂ Sensor, 6면 가열 방식으로 뛰어난 온도 분포도

Maker	MMM (Germany)
제품명	CO2cell
용량	50, 190 L
온도 범위	상온 +5 ~ 60 °C
CO ₂ 농도	0.1 ~ 20 %
옵션	8-Split Inner Door, 160/200 °C 멸균
IQ/OQ	가능

저온 배양기

Low Temperature Incubator



- 용도 : 저온 미생물 배양시 저온 유지, 식물 성장 등
- 특징 : 배지 마름 현상이 적음

Maker	MMM (Germany)
제품명	Friocell ECO
용량	55, 111, 222, 404, 707, 1212 L
온도 범위	0 ~ 100 °C
옵션	외부연결 포트, -10 °C 옵션
IQ/OQ	가능

저온 배양기

Low Temperature Incubator



- 용도 : 저온미생물 배양, 식물생장 등
- 특징 : 광 트레이 장착시 ICH Guideline Q1B에 적합한 광 안정성 시험 가능

Maker	MMM (Germany)
제품명	Friocell EVO
용량	55, 111, 222, 404, 707, 1212 L
온도 범위	0 ~ 100 °C
옵션	광 트레이 (UV/VIS), -20 °C 옵션 농도 조절, 외부연결 포트
IQ/OQ	가능

Refrigerator | Freezer

냉장고

Refrigerator



- 용도 : 시약, 시료, 균주, 표준품 보관
- 특징 : $\pm 3^{\circ}\text{C}$ 이내의 정밀한 온도 제어, KP, USP, EP 등 기준에 적합한 제품

Maker	Fiocchetti (Italy)
제품명	Medika / Medika 2T
용량	Medika : 100 ~ 1,500 L (9개 용량) Medika 2T : 280 ~ 1,500 L (7개 용량)
온도 범위	+2 ~ 15 °C (0.1 °C 단위 정밀제어)
도어	3중 압축 유리
옵션	도어락, 외부 연결 포트, 기록계
IQ/OQ	가능

냉장고

Refrigerator



- 용도 : 시약, 시료, 균주, 표준품 보관
- 특징 : $\pm 3^{\circ}\text{C}$ 이내의 정밀한 온도 제어, KP, USP, EP 등 기준에 적합한 제품

Maker	Fiocchetti (Italy)
제품명	Labor
용량	100 ~ 1,500 L (9개 용량)
온도 범위	2 ~ 15 °C (0.1 °C 단위 정밀제어)
도어	Solid Door
옵션	도어락, 외부 연결 포트, 기록계
IQ/OQ	가능

상온 냉장고

Refrigerator



- 용도 : 시약, 시료, 균주, 표준품 보관
- 특징 : $\pm 3^{\circ}\text{C}$ 이내의 정밀한 온도 제어, KP, USP, EP 등 기준에 적합한 제품

Maker	Fiocchetti (Italy)
제품명	TER
용량	140, 200, 400, 700 L
온도 범위	15 ~ 30 °C (0.1 °C 단위 정밀제어)
도어	Solid Door
옵션	도어락, 외부 연결 포트, 기록계
IQ/OQ	가능

냉동고

Freezer



- 용도 : 표준품, 냉동약품, 시료 등 장/단기간 보관 시 사용
- 특징 : $\pm 5^{\circ}\text{C}$ 이내의 정밀한 온도 제어, KP, USP, EP 등 기준에 적합한 제품

Maker	Fiocchetti (Italy)
제품명	Freezer
용량	140, 250, 400, 700, 1500 L
온도 범위	-25 ~ -10 °C
도어	Solid Door
옵션	도어락, 외부 연결 포트, 기록계
IQ/OQ	가능

냉동고

Freezer



- 용도 : 표준품, 냉동약품, 시료 등 장/단기간 보관 시 사용
- 특징 : $\pm 5^{\circ}\text{C}$ 이내의 정밀한 온도 제어, KP, USP, EP 등 기준에 적합한 제품

Maker	Fiocchetti (Italy)
제품명	Vision
용량	400, 700 L
온도 범위	-20 ~ -10 °C
도어	3중 압축 유리
옵션	도어락, 외부 연결 포트, 기록계
IQ/OQ	가능

냉동고

Freezer



- 용도 : 표준품, 냉동약품, 시료 등 장/단기간 보관 시 사용
- 특징 : $\pm 5^{\circ}\text{C}$ 이내의 정밀한 온도 제어, KP, USP, EP 등 기준에 적합한 제품

Maker	Fiocchetti (Italy)
제품명	Superartic
용량	250, 400, 700 L
온도 범위	-40 ~ -20 °C
도어	Solid Door
옵션	도어락, 외부 연결 포트, 기록계
IQ/OQ	가능

Refrigerator & Freezer | Deep Freezer

냉장 · 냉동고

Refrigerator & Freezer



- 용도 : 시약, 시료, 균주, 표준품 보관
- 특징 : 냉장고 + 냉동고 Double Chamber

Maker	Fiocchetti (Italy)
제품명	Vision 2T
용량	400, 500, 700 L
온도 범위	냉장고 : +2 ~ +15 °C 냉동고 : -20 ~ -15 °C
도어	3중 압축 유리
옵션	도어락, 외부 연결 포트, 기록계
IQ/OQ	가능

냉장 · 냉동고

Refrigerator & Freezer



- 용도 : 시약, 시료, 균주, 표준품 보관
- 특징 : 냉장고 + 냉동고 Double Chamber

Maker	Fiocchetti (Italy)
제품명	Labor 2T
용량	280, 400, 500, 700 L
온도 범위	냉장고 : +2 ~ +15 °C 냉동고 : -24 ~ -10 °C
도어	Solid Door
옵션	도어락, 외부 연결 포트, 기록계
IQ/OQ	가능

냉장 · 냉동고

Refrigerator & Freezer



- 용도 : 시약, 시료, 균주, 표준품 보관
- 특징 : 냉장고 + 냉동고 Double Chamber

Maker	Fiocchetti (Italy)
제품명	Superartic 2T
용량	700 L
온도 범위	냉장고 : +2 ~ +10 °C 냉동고 : -35 ~ -10 °C
도어	Solid Door
옵션	도어락, 외부 연결 포트, 기록계
IQ/OQ	가능

초저온 냉동고

Deep Freezer



- 용도 : Bio Sample을 안정적으로 장기간 보관
- 특징 : 뛰어난 온도 유지능력, 균일한 온도 분포도

Maker	Froilabo (France)
용량	340, 515, 690 L
컨트롤러	TRUST (Display상 Status만 표시)
온도 범위	-86 °C (-60 to -86 °C) -45 °C (-20 to -45 °C)
온도 정확도	±1°C
온도 분포도	±3°C
IQ/OQ	가능

대용량 초저온 냉동고

Deep Freezer (BMT Series)



- 용도 : Bio Sample을 안정적으로 장기간 보관
- 특징 : 뛰어난 온도 유지능력, 균일한 온도 분포도, 터치 스크린

Maker	Froilabo (France)
용량	1000 L
온도 범위	-86 °C (-55 to -90 °C)
온도 정확도	±1 °C
온도 분포도	±3 °C
IQ/OQ	가능

Autoclave | Large Capacity Autoclave

멸균기

Autoclave



- 용도 : 배지, 기구, 폐기물 등의 멸균
- 특징 : 멸균 후 자동 냉각으로 빠른 멸균시간

Maker	TOMY (Japan)
제품명	SX-300 / 500 / 700
용량	44 / 58 / 79 L
온도 범위	105 ~ 135℃
옵션	잉크프린터, External Sensor
IQ/OQ	가능

Capacity of Basket for Flask

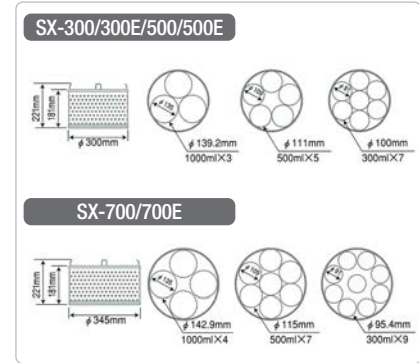

대용량 멸균기

Autoclave (Large Capacity)



100ℓ

- 용도 : 배지, 기구, 폐기물 등의 멸균
- 특징 : 대형 사이즈, 낮은 높이

Maker	TOMY (Japan)
제품명	FLS-1000
용량	100 L
온도 범위	105 ~ 135℃
옵션	잉크프린터, External Sensor
옵션	가능

Perfect Height Design

78.5 cm

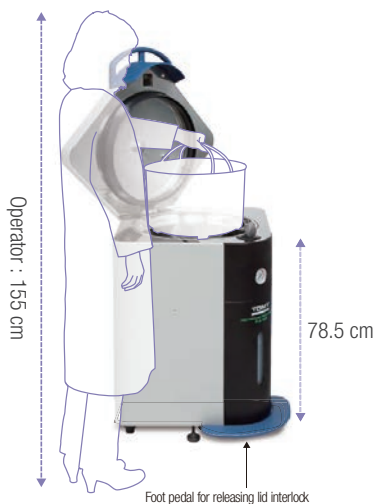

Wide Chamber

45 cm



45 cm Wide Chamber

Option



Stainless Basket

Stainless Bucket

Stainless Long Basket

Selective Lid Opening

Left OR Right

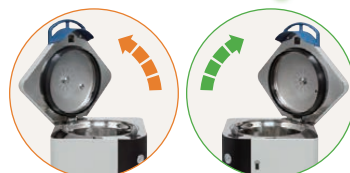

Capacity of Basket for Flask



5,000 mL × 4pcs

Autoclave | Sterilizer

멸균기

Autoclave with Drier



- 용도 : 배지, 기구, 폐기물 등의 멸균
- 특징 : 멸균 후 자동 건조기능

Maker	TOMY (Japan)
제품명	SDL-320
용량	55 L
온도 범위	60 ~ 132 °C
옵션	바스켓 용도에 따라 선택가능
IQ/OQ	가능

멸균기

Autoclave



- 용도 : 배지, 기구, 폐기물 등의 멸균
- 특징 : 불안전 멸균방지, 챔버 과열 및 과압력 방지

Maker	TOMY (Japan)
제품명	ES Series
용량	22, 53 L
온도 범위	105 ~ 132 °C (모델에 따라 상이)
옵션	바스켓 용도에 따라 선택가능
IQ/OQ	가능

레토르트 멸균기

Retort Sterilizer



- 용도 : 레토르트 제품 멸균
- 특징 : 냉각 시 내부압력을 유지하여 포장 제품의 파손 방지

Maker	TOMY (Japan)
제품명	SR-240
용량	21 L
온도 범위	100 ~ 140 °C
옵션	바스켓 용도에 따라 선택가능
IQ/OQ	가능

건열 멸균기

Hot Air Sterilizer



- 용도 : 건열멸균, Endotoxin 멸균
- 특징 : Depyrogen (250 °C)용도로 안정된 온도분포도

Maker	MMM (Germany)
제품명	Stericell
용량	22, 55, 111, 222, 404 L
온도 범위	상온 +10 ~ 250 °C
옵션	Two-Door, 외부 Stainless Steel, HEPA-Filter 등
IQ/OQ	가능

대형 증기 멸균기

Large Steam Sterilizer



- 용도 : 무균시험도구, 무균복, 액체배지, 무균제제 등 멸균
- 특징 : EN285, EN544 등 국제 기준에 적합

Maker	BMT (Germany)
제품명	Sterivap
용량	73 ~ 1,490 L
온도 범위	100 ~ 134 °C
옵션	2 Door (Passing-Through)
IQ/OQ	가능

탁상형 증기 멸균기

Bench Top Sterilizer



- 용도 : 무균시험도구, 무균복, 액체배지, 무균제제 등 멸균
- 특징 : 다양한 멸균 프로그램 내장되어있어 간편 사용 가능

Maker	BMT (Germany)
제품명	Sterilab
용량	25 L
온도 범위	100 ~ 134 °C
옵션	RS 232
IQ/OQ	가능

BSC (Bio Safety Cabinet) | Clean Bench

생물안전작업대

Bio Safety Cabinet

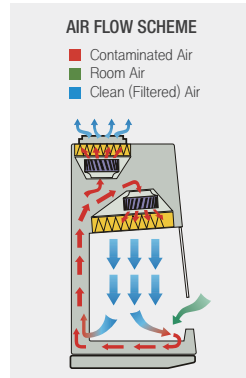

- 용도 : 병원성 바이오 작업 시 공기 중 감염으로부터 사용자 및 환경 보호
- 특징 : Class II TYPE A2, 터치 기능, Neoteric의 상위 버전

Maker	LAMSYSTEMS (Germany)
제품명	SAVVY
용량	가로 0.9/1.2/1.5/1.8 m
인증	EN 12469
옵션	멀티탭, 울트라필터
IQ/OQ	가능

생물안전작업대

Bio Safety Cabinet

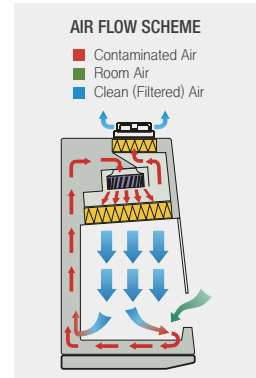

- 용도 : 병원성 바이오 작업 시 공기 중 감염으로부터 사용자 및 환경 보호
- 특징 : Class II TYPE A2, 버튼 형식

Maker	LAMSYSTEMS (Germany)
제품명	NEOTERIC
용량	가로 0.9/1.2 m
인증	EN 12469
옵션	멀티탭, 울트라필터
IQ/OQ	가능

LAMSYSTEMS BSC 특징

유압으로 130도 자동 Open 및 전면 Sash 코너 부분 Marking



실험자의 편리함을 더하기 위한 Arm Support



전면 Sash 부분 Laminated Glass로 사용자 안전 확보

클린벤치

Clean Bench

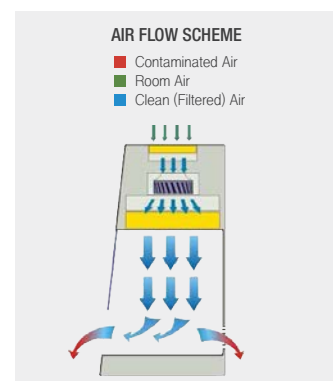

- 용도 : 실험 (시료)을 보호 하기 위해 무균 공기를 캐비닛 내부로 공급하여 오염이 없는 작업 환경을 제공해 주는 장비
- 특징 : 오염방지 코팅된 금속 프레임, 스테인리스 작업대, 측면 유리, 수직 층류형

Maker	LAMSYSTEMS (Germany)
제품명	BAVnp-01-Laminar-S
용량	가로 1.2, 1.5, 1.8 m
옵션	UV Lamp

Fume Hood | Clean Bench | Balance Enclosure

화학 실험용 작업대

Ductless Chemical Workstation



- 용도 : 유해가스가 발생하는 실험에서 사용자 보호
- 특징 : 공기 흐름 속도 자동 조절 기능

Maker	AirClean Systems (USA)
제품명	AC600 Series
재질	가볍고 내화학성이 높아 녹이 슬지 않는 Polycarbonate (벽면), Polypropylene (바닥) 재질
필터	Bonded Carbon Filter, Pre-Filter
인증	UL, CSA & CE 인증
소음	< 49 dBA

덕트리스 흡후드

Ductless Fume Hood



- 용도 : 유해가스가 발생하는 실험에서 사용자 보호
- 특징 : Horizontal 방식의 공기 흐름으로 실험자 안전 최우선 고려

Maker	AirClean Systems (USA)
제품명	AC3000~6000 Series
재질	가볍고 내화학성이 높아 녹이 슬지 않는 Polycarbonate (벽면), Polypropylene (바닥) 재질
필터	Bonded Carbon, HEPA Filter, Pre-Filter
인증	UL, CSA & CE 인증
설치	덕트 공사가 필요 없어 경제적이며 간편

PCR 작업대

PCR Workstation



- 용도 : BIO (DNA/RNA) 및 미생물 관련 실험에서 검체 보호
- 특징 : 공기 흐름 속도 자동 조절 기능, Class100 (ISO5) 이하의 환경을 요하는 실험에 적합

Maker	AirClean Systems (USA)
제품명	AC600LFUVCS
재질	가볍고 내화학성이 높아 녹이 슬지 않는 Polycarbonate (벽면), Polypropylene (바닥) 재질
필터	Bonded Carbon Filter
인증	UL, CSA & CE 인증, ISO 5 Vertical Laminar Airflow (Class100) 충족
포함	UV 살균등, HEPA 필터, 피펫 거치대

층류형 무균 작업대

Laminar Flow Workstation



- 용도 : BIO (DNA/RNA) 및 미생물 관련 실험에서 검체 보호
- 특징 : Class100 (ISO5)이하의 환경을 요하는 실험에 적합

Maker	AirClean Systems (USA)
제품명	AC5000
재질	내화학성이 높아 녹이 슬지 않는 Polypropylene 재질
필터	Bonded Carbon, HEPA Filter
인증	UL, CSA & CE 인증, ISO 5 Vertical Laminar Airflow (Class100) 충족
포함	UV 살균등, HEPA 필터

저울용 흡후드

Balance Enclosure



- 용도 : 유해물질의 분진이 발생하는 실험에서 사용자 보호를 위해 사용
- 특징 : 손쉬운 Filter 교체방식으로 누구나 쉽게 사용 가능

Maker	AirClean Systems (USA)
제품명	Powdersafe Type A
재질	가볍고 내화학성이 높아 녹이 슬지 않는 Polycarbonate (벽면), Polypropylene (바닥) 재질
필터	Bonded Carbon, HEPA Filter
인증	UL, CSA & CE 인증
설치	덕트 공사가 필요 없어 경제적이며 간편

저울용 흡후드

Horizontal Laminar Flow Balance Enclosure



- 용도 : 유해물질의 분진이 발생하는 실험에서 사용자 보호를 위해 사용
- 특징 : 2중 HEPA Filter로 분진 제거에 탁월

Maker	AirClean Systems (USA)
제품명	Powdersafe Type B
재질	가볍고 내화학성이 높아 녹이 슬지 않는 Polycarbonate (벽면), Polypropylene (바닥) 재질
필터	Bonded Carbon, HEPA Filter
인증	UL, CSA & CE 인증
설치	덕트 공사가 필요 없어 경제적이며 간편

Safety Storage Cabinet

인화성 물질 보관 안전 캐비닛

Storage of Flammable Products



TYPE 90

- 용도 : 인화성 물질 보관 캐비닛
- 특징 : 화재 시 90분간 캐비닛 내부 온도 유지

Maker	LSS (Italy)
제품명	Smart Line
TYPE	TYPE 90 (90분)
재질	산화방지 스틸
인증	유럽안전인증 [EN 14470-1 (화재 테스트), EN 14727 (내구성 테스트)]
잠금 장치	도어 잠금장치

인화성 물질 보관 안전 캐비닛

Storage of Flammable Products



TYPE 90

TYPE 30

- 용도 : 인화성 물질 보관 캐비닛
- 특징 : 화재 시 각각 30, 90분간 캐비닛 내부 온도 유지

Maker	LSS (Italy)
제품명	CM / CME / T30 Line
TYPE	TYPE 90 (90분), TYPE 30 (30분)
재질	산화방지 스틸
인증	유럽안전인증 [EN 14470-1 (화재 테스트), EN 14727 (내구성 테스트)]
잠금 장치	도어 잠금장치

인화성 & 산·염기 물질 보관 캐비닛

Combined Storage of Chemical and Flammable Products



TYPE 90

CE

- 용도 : 인화성 & 산·염기 물질 보관 캐비닛
- 특징 : 용도별 분리 보관 가능 (인화성/산염기)

Maker	LSS (Italy)
제품명	강제 환기형 캐비닛 / 배출시스템 선택형 캐비닛
TYPE, IPX	TYPE90 (90분) 및 IPX4등급
재질	산화방지 스틸
인증	유럽안전인증 [EN 14470-1 (화재 테스트), EN 14727 (내구성 테스트)]
잠금 장치	도어 잠금 장치

산·염기 물질 보관 안전 캐비닛

Storage of Chemicals, Acids and Based Products



- 용도 : 산·염기 물질 보관 캐비닛
- 특징 : 사용자 보호를 위한 E-Flow System으로 안전한 사용

Maker	LSS (Italy)
제품명	강제 환기형 캐비닛 / 배출시스템 선택형 캐비닛
내산성	Epoxide Coating
재질	산화방지 스틸
인증	유럽안전인증 EN 14727 (내구성 테스트)
잠금 장치	도어 잠금 장치

산·염기 물질 보관 안전 캐비닛

Storage of Chemicals, Acids and Based Products



- 용도 : 산·염기 물질 보관 캐비닛
- 특징 : 실험실 조건에 따른 배출 시스템 선택 가능

Maker	LSS (Italy)
제품명	배출시스템 선택형 캐비닛
내산성	Epoxide Coating
재질	산화방지 스틸
인증	유럽안전인증 EN 14727 (내구성 테스트)
잠금 장치	도어 잠금 장치

Furnace

머플 퍼니스

Muffle Furnace



- 용도 : 소성 및 소결, 강열감광 시험, 강열잔분 시험
- 특징 : 높은 온도 분포도를 위한 이중벽 하우징, 좌·우 양면 가열방식

Maker	Nabertherm (Germany)
제품명	L/LT Series
용량	3, 5, 9, 15, 24, 40 L
온도 범위	최대 1300 °C
외부 재질	Stainless Steel
컨트롤 방식	조그 (JOG)타입 컨트롤러
IQ/OQ	가능

튜브 퍼니스

Tube Furnace



- 용도 : 가스 분위기 화합물 열처리 작업
- 특징 : 튜브 재질 교체 가능, 수평/수직형 선택 가능

Maker	Nabertherm (Germany)
제품명	RSC/RSH Series
가열 구간	1-Zone, 3-Zone
구간별 온도 정밀도	±5 °C
컨트롤 방식	조그(Jog)타입 컨트롤러
옵션	가스 공급 패키지, 진공 적입 가스공급 패키지
IQ/OQ	가능

치과용 퍼니스

Dental Furnace



- 용도 : 고온 열처리 작업
- 특징 : 위, 아래로 구동되는 리프트 테이블, 원형 가열을 통한 높은 온도 균일성

Maker	Nabertherm (Germany)
제품명	LHT Series
내부 용량	2, 16 L
온도 범위	최대 1700 °C
발열체	고순도 이규화몰리브덴 (MoSi ₂)
컨트롤 방식	조그(Jog)타입 컨트롤러
옵션	과열방지장치, 가스 퍼징용 보호가스 연결장치

고온 진공 퍼니스

High Temperature Vacuum Furnace



- 용도 : 고온 진공 열처리 작업
- 특징 : 고순도 수소나 기타 가연성 가스 조건에서 열처리 가능

Maker	Nabertherm (Germany)
제품명	VHT Series
내부 용량	8, 40, 70, 100, 500 L
온도 범위	1800 ~ 2200 °C
옵션	부분압력 챔버, 배기가스 토치 (Burning) 시스템 (전기 / 가스식 선택가능)
발열체	Graphite, Molybdenum, Tungsten
컨트롤 방식	터치스크린방식 (12인치 디스플레이)

Nabertherm 제품의 장점



온도 균일성 우수

타사 대비 높은 온도 균일도 (±5 °C)



품질 및 신뢰성

시뮬레이션 테스트를 통한 최적의 제품 생산

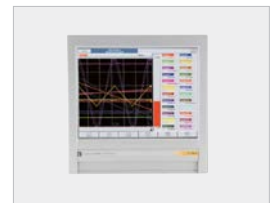

온도 기록 장치

터치스크린 디스플레이



컨트롤러

온도구간별 승온속도 조절 가능 (C450)



Customer Test Center 보유

공정별 Sample Test 및 의뢰 가능



소프트웨어

공정 전체를 소프트웨어만으로 컨트롤 가능

Centrifuge

미니원심분리기-One Spin

Mini Personal Centrifuge



- 용도 : 간편한 원심분리 목적
- 특징 : 1개의 튜브도 사용가능

Maker	TOMY (Japan)
제품명	One-Spin
속도	4,000 rpm
G-force	420 ~ 1,000 G
최대 수용량	2 mL (1.5 mL) X 4 microtubes

미니원심분리기-Multi Spin

Mini Personal Centrifuge



- 용도 : 간편한 원심분리 목적
- 특징 : 배터리 or 아답터 사용
BSC, Clean Bench 내부 사용가능

Maker	TOMY (Japan)
제품명	Multi-Spin
속도	6,000 rpm/6,200 rpm
G-force	1,260 ~ 1,960 G / 810 ~ 2,690 G
최대 수용량	2 mL (1.5 mL) X 8 microtubes/ 0.2 mL X 8 PCR tubes

고속냉장 원심분리기

High Speed Refrigerated Centrifuge



- 용도 : 고속 냉장 원심분리 목적
- 특징 : 빠른 가속 및 감속으로 실험 시간 절약

Maker	TOMY (Japan)
제품명	SUPREMA 25/23/21
최대속도	25,000 rpm / 23,000 rpm / 21,000 rpm
G-force	60,110 G / 51,420 G / 46,850 G
사용가능튜브	2, 5, 15, 50, 250, 500, 1000 mL Deep Well Plate, Micro Plate

고속냉장 원심분리기

High Speed Refrigerated Centrifuge



- 용도 : 고속 냉장 원심분리 목적
- 특징 : 편리한 터치스크린 패널

Maker	TOMY (Japan)
제품명	MDX-310
최대속도	15,000 rpm
G-force	21,130 G
최대 수용량	50 mL X 4

Rack-In-Rotor System

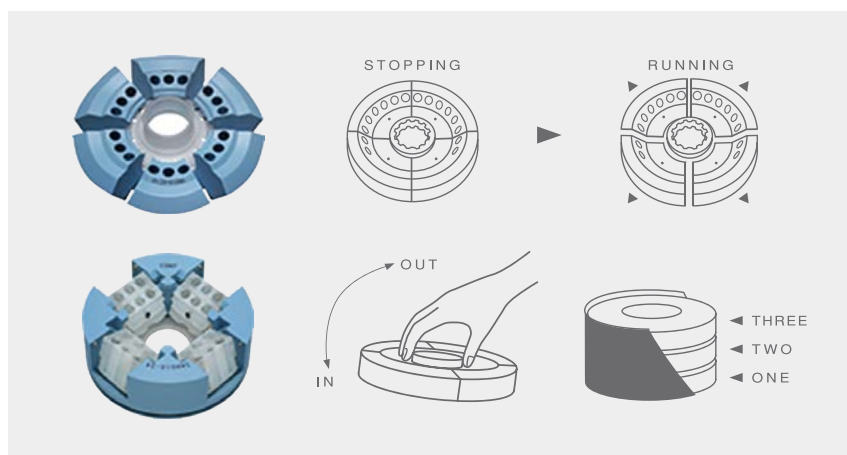

- 작동시 Rack이 분할되어 Rotor 벽면에 부착되는 메커니즘을 적용하여 안정성이 뛰어남
- Rack을 Rotor에 고정할 필요가 없어 이동성이 뛰어남
- Rotor안에 3단까지 Rack 적재 가능

Ultrasonicator

초음파세척기 (Easy)

Ultrasonicator



- 용도 : 기구세척, 용존가스 제거, 샘플 전처리
- 특징 : 커버기본 제공

Maker	Elma (Germany)
제품군	Easy Series
용량	0.8 ~ 28 L
온도 범위	30 ~ 80 °C (Option)
초음파 세기	30 ~ 300 W
Accessory 옵션	Basket

초음파세척기 (S Series)

Ultrasonicator



- 용도 : 기구세척, 용존가스 제거, 샘플 전처리
- 특징 : Degas-Function, Sweep-Function

Maker	Elma (Germany)
제품군	S Series
용량	0.8 ~ 90 L
온도 범위	30 ~ 80 °C (Option)
초음파 세기	37 kHz
Accessory 옵션	커버, Basket

초음파세척기 (P Series)

Ultrasonicator



- 용도 : 기구세척, 용존가스 제거, 샘플 전처리
- 특징 : Degas-Function, Sweep-Function, Individual Power Regulation

Maker	Elma (Germany)
제품군	P Series
용량	2.75 ~ 28 L
온도 범위	30 ~ 80 °C (Option)
초음파 세기	37 kHz, 80 kHz
Accessory 옵션	커버, Basket

Elma 초음파 세척기 액세서리



Magnetic Stirrer

싱글 자력 교반기

Single Magnetic Stirrer



- 용도 : 시료의 혼합 목적
- 특징 : Power Setting으로 고점도 시료 교반 가능

Maker	2mag (Germany)
용량	1 ~ 10,000 mL
속도	100 ~ 2,000 rpm (모델별 확인)
제품군	MIX1, MIX1eco, luMIX, AccuMIX
사용 환경	-10 °C ~ 50 °C (at 80% Humidity) 최대 95 % 수중 사용 가능 (일부 모델)
IP 등급	IP64, IP68

멀티 자력 교반기

Multi Magnetic Stirrer



- 용도 : 같은 조건으로 각각의 시료 혼합 목적
- 특징 : Power Setting으로 고점도 시료 교반 가능

Maker	2mag (Germany)
용량	1 ~ 3,000 mL (모델별 확인)
속도	100 ~ 2000 rpm (모델별 확인)
교반점	4, 6, 8, 12, 15구
사용 환경	-10 °C ~ 50 °C (at 80% Humidity)
IP 등급	IP64, IP68

산업용 교반기

Industrial Stirrer



- 용도 : 대용량 시료 혼합 목적
- 특징 : 산업현장에서 무인 작동 가능 (MixWatch)

Maker	2mag (Germany)
용량	1 ~ 40 L
속도	60 ~ 2,000 rpm (모델별 확인)
기능	모니터링 가능한 MIXwatch 기능
사용 환경	-10 °C ~ 50 °C (at 95% Humidity)
IP 등급	IP64, IP66

세포배양 교반기

Cellculture Stirrer



- 용도 : 세포배양용 시료 혼합 목적
- 특징 : Slow Moving 및 고습도 환경 사용 가능

Maker	2mag (Germany)
용량	5 ~ 5,000 mL
속도	5 ~ 250 rpm
세기	10단계 조절 (10 ~ 100 %)
사용 환경	10 °C ~ 50 °C (at 80 % Humidity)
IP 등급	IP64, IP68

가열 교반기

Heating Stirrer



- 용도 : 시료를 고온에서 혼합 목적
- 특징 : 가열과 동시에 교반 가능

Maker	2mag (Germany)
용량	1 ~ 2,000 mL
속도	100 ~ 1,600 rpm
온도 범위	+200 °C
사용 환경	-10 °C ~ 40 °C (at 80% Humidity)
IP 등급	IP20

장비장착용 초소형 교반기

OEM Single Magnetic Stirrer



- 용도 : 시료의 혼합 목적
- 특징 : OEM 형태의 초소형 교반기로 장비 내부에 설치 가능

Maker	2mag (Germany)
용량	1~1,000 mL
속도	120~1,200 rpm (기본 컨트롤러 시)
규격	45 X 48 X 18 mm (w x d x h)
IP 등급	IP68

Water Bath | Chiller

순환수조

Circulating Bath



- 용도 : 저온에서 고온까지 컨트롤이 필요한 시료 전처리
- 특징 : Class III Safety로 과온도 보호 및 제한 온도 설정 가능

Maker	Polyscience (USA)
제품군	MX, SD, AD, AP
온도 범위	-40 ~ 200 °C (Controller에 따라 상이)
용량	6 ~ 75 L (Controller에 따라 상이)
온도 안정성	최고 ±0.005 °C (Controller에 따라 상이)

프리미엄 항온수조

High Lid Digital Water Bath



- 용도 : 고온에서 시료 전처리
- 특징 : 0.1 °C 단위 정밀한 온도 조절 및 신속한 목적온도 도달

Maker	Polyscience (USA)
제품군	General Purpose Water Bath
온도 범위	상온 +5 ~ 100 °C
용량	2, 5, 10, 20, 28 L
정확도	온도 안정성 : ±0.1 °C 온도 균일성 : ±0.2 °C

점도측정 수조

Viscosity Bath



- 용도 : 시료의 점도 측정
- 특징 : ASTM D-445의 특수 시험 및 품질관리 수행 가능

Maker	Polyscience (USA)
제품군	Polycarbonate Bath, Glass Bath
온도 범위	Polycarbonate Bath : 85 °C Glass Bath : 135 °C
용량	2, 2 (Shallow), 5, 10, 20, 28 L
온도 안정성	최고 ±0.1 °C

탁상용 냉각 순환기

Benchtop Chiller



- 용도 : 저온에서 시료 전처리
- 특징 : 3개의 온도 프로그램 저장 가능

Maker	Polyscience (USA)
제품군	LS, LM, MM Series
온도 범위	-20 ~ 50 °C (모델별 상이)
용량	6~75 L (Controller 모델별 상이)
온도 안정성	최고 ±0.005 °C (Controller 모델별 상이)

이동식 재순환 냉각기

Portable Recirculating Chiller

신제품



- 용도 : 저온에서 시료 전처리
- 특징 : Touch Screen Display, Self-Cleaning Filter System, UV Light Biological Growth Inhibitor System

Maker	Polyscience (USA)
제품군	CA Series (터빈 펌프, 용적형 펌프 타입 선택 가능)
온도 범위	-10 ~ 70 °C
냉각 용량	850 ~ 2900 W
온도 안정성	±0.1 °C



Full Color Touch Screen Display



Continuous Liquid Level Monitoring



Dynamic Self Changing Filter



UV Light Biological Growth Inhibitor

Homogenizer | Heat Sealer

핸드 타입 균질기

Handheld Homogenizer



- 용도 : 시료의 분쇄, 혼합을 위한 균질화
- 특징 : 간편한 사용 및 휴대성 강화

Maker	PRO Scientific (USA)
제품명	PRO 200
Probe	0.5 ~ 50 mL
시료 용량	0.03 ~ 1,000 mL
속도	5,000 ~ 30,000 rpm
옵션	Stand 별도 구매

탁상용 균질기

Digital Benchtop Homogenizer



- 용도 : 시료의 분쇄, 혼합을 위한 균질화
- 특징 : Digital 제어 및 손쉬운 세척으로 편의성 증대

Maker	PRO Scientific (USA)
제품명	PRO D-Series
Probe	다양한 용량 제공
시료 용량	0.03 mL ~ 30 L
속도	~ 28,000 rpm
옵션	Stand 포함

멀티샘플 자동 균질기

Multi-Prep Homogenizer



- 용도 : 시료의 분쇄, 혼합을 위한 자동 균질화 장비
- 특징 : 여러 시료를 동시에 자동으로 균질화 가능

Maker	PRO Scientific (USA)
제품명	Multi-Prep
Package	Tube Rack, 7 mm Probe 12 pk 포함
시료 용량	15 ~ 50 mL
속도	2,000 ~ 18,000 rpm
옵션	Tube Rack, Probe Package (12ea)

온도 가변형 가열 밀봉기

Heat Sealer



- 용도 : 시료 밀봉 시 가열하여 Seal과 Plate 부착
- 특징 : 온도, 시간 설정으로 균일하게 밀봉, 밀봉 후 피펫 사용 가능

Maker	Viti (UK)
제품명	VTS Heat Sealer
온도 범위	125 ~ 200 °C (1 °C씩 조절)
밀봉 시간	1 ~ 9 초 (0.5초씩 조절)
가열 시간	170 °C까지 10분 이내 도달
옵션	다양한 종류의 Foil&Film, Plate 선택

온도 고정형 가열 밀봉기

Heat Sealer



- 용도 : 이동식 유체 점도 측정
- 특징 : 4 kg 초경량의 공간 절약형 디자인

Maker	Viti (UK)
제품명	MTS Heat Sealer
온도 범위	170 ± 2 °C
밀봉 시간	1 ~ 9 초 (0.5초씩 조절)
가열 시간	170 °C까지 10분 이내 도달
옵션	다양한 종류의 Foil&Film, Plate 선택

악세서리

Accessories

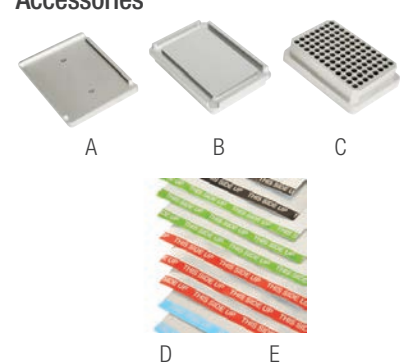

- 용도 : Heat Sealer용 악세서리
- 특징 : 다양한 타입의 Microplate 및 Film 선택 가능

Maker	Viti (UK)
A	Deep Well Plates
B	96 Well MTP, 384 Well MTP 96 Well Skirted PCR Plate
C	96 Well Semi-Skirted PCR Plate
D	필름 (투명, 75, 105 μm)
E	포일 (20, 38, 70, 85 μm)

Kjeldahl System | Fat Extraction System

킬달 증류 장치

Steam Distillation Unit



- 용도 : 킬달 방법의 증류과정을 편리하게 이용
- 특징 : 반응과 증류시간을 프로그래밍 가능

Maker	OMNILAB (Germany)
제품명	D Series
D1000	자동 증기 발생, 자동 NaOH 첨가
D2000	자동 증기 발생, 자동 NaOH & H ₂ O 첨가
D3000	자동 증기 발생, 자동 NaOH & H ₂ O 첨가
D4000	자동 증기 발생, 자동 NaOH & H ₂ O, H ₂ BO ₃ 첨가
D5000	자동 증기 발생, 자동 NaOH & H ₂ O, H ₂ BO ₃ 첨가, 외부 적정기와 프린터 연결 가능

킬달 고속분해 장치

Infrared Rapid Digestion



- 용도 : 킬달 방법의 증류과정을 편리하게 이용
- 특징 : 고속 가열-1분 안에 830 °C 도달

Maker	OMNILAB (Germany)
제품명	IR Series
가열 방식	IR (적외선)
가열기 재질	석영
분해 용기	6, 12 구 / 250, 400, 800 mL 용기
프로그램	최대 10개의 프로그램 저장 가능

킬달 분해 장치

Kjeldahl Block Digestion System



- 용도 : 킬달 방법의 증류과정을 편리하게 이용
- 특징 : 최대 450 °C까지 가열 가능

Maker	OMNILAB (Germany)
제품명	MBS & SBS Series
온도조절 범위	~450 °C
재질	스테인리스 스틸
분해 용기	8, 16, 20, 40 구 / 100, 250, 400 mL 용기
프로그램	최대 10개의 프로그램 저장 가능

조지방 추출장치

Fat Extraction System



- 용도 : 식품에 함유된 지방 성분 측정 시 사용
- 특징 : Randall법으로 전통적인 추출법보다 5배 빠른 추출 속도

Maker	OMNILAB (Germany)
제품명	RD Series
추출법	Randall Method
냉각	모든 시료 용기에 동일한 냉각
추출 용기	4 구 / 100 mL 용기
포함	25 Extraction Thimbles of 100mL 포함

조지방 추출장치

Fat Extraction System



- 용도 : 식품에 함유된 지방 성분 측정 시 사용
- 특징 : Soxhlet 또는 Twisselmann 법에 따른 표준 지방추출에 사용

Maker	OMNILAB (Germany)
제품명	RS & RT Series
추출법	Soxhlet, Twisselmann Method
냉각	모든 시료 용기에 동일한 냉각
추출 용기	1, 4, 6 구 / 250 mL 용기
포함	유리 시료용기, 지지대 포함

가수분해 장치

Hydrolysis System



- 용도 : 지방 측정 시 지질을 추출 가능한 형태로 변환
- 특징 : 각 위치의 시료를 개별 조절 가능

Maker	OMNILAB (Germany)
제품명	RH Series
추출법	Weibull-Stoldt Method
냉각	모든 시료 용기에 동일한 냉각
분해 용기	4, 6 구 / 600 mL 용기
포함	렉, 시료 용기, 필터 유닛 포함

Diluter | Stomacher | Air Sampler

자동중량 희석기

Gravimetric Diluter



- 용도 : 시료의 희석 시 사용
- 특징 : 2단계의 희석액 투입으로 시간 절약과 높은 정확도를 가짐

Maker	IUL (Spain)
제품명	Smart Diluter W
희석비율	2 ~ 1,000 배 조정 가능
외부 포트	RS 232
멸균	튜브 및 희석제 접촉 부분 멸균 가능
IQ/OQ	가능

시료 균질기

Stomacher



- 용도 : 고형 및 반고형 시료의 균질 및 시료의 용액 추출
- 특징 : 균질화 과정 중 교차 오염 방지

Maker	IUL (Spain)
제품명	Masticator
용량	80 ~ 3,500 mL
속도	500 ~ 3,100 rpm (제품별 상이)
옵션	바코드 리더기, 유리문 선택 가능
IQ/OQ	가능

부유균 측정기

Air Sampler



- 용도 : 부유 세균 측정을 위한 장비
- 특징 : Petri Dish의 회전으로 배지 전체를 고르게 사용

Maker	IUL (Spain)
제품명	Spin Air
공기 흡입	10 ~ 9,900 L
속도	0 ~ 4 rpm
옵션	90, 60 mm 페트리디쉬
IQ/OQ	가능

시료자동분주기

Dilution Spreading



- 용도 : 배지의 일정 구역에 자동으로 정량의 시료 분주
- 특징 : 구역별로 다른 희석 비율로 접종 가능

Maker	IUL (Spain)
제품명	Eddy Jet 2
유량	최대 50 µL/s
재현성	± 1 %
외부 포트	RS 232를 통해 Printer와 외부 Balance 연결
IQ/OQ	가능

수동 균수측정기

Manual Colony Counter



- 용도 : 배지의 균을 계수
- 특징 : 배지에 직접 접촉 가능한 두 종류의 포인터로 편리한 계수 가능

Maker	IUL (Spain)
제품명	DOT-Colony Counter
측정	4 Digits LED Display
최대 계수량	9999
옵션	클릭 영구 마커, 스테인리스 포인터
IQ/OQ	가능

자동 균수측정기

Automated Colony Counter



- 용도 : PC를 이용하여 자동으로 균 계수
- 특징 : 균의 수 또는 특정 구역을 삭제 또는 추가 가능

Maker	IUL (Spain)
제품명	Sphere Flash®
사용가능 직경	90 mm
사용환경	10 ~ 75 % 습도
소프트웨어 옵션	Colonies PRO, Halos PRO
IQ/OQ	가능

Zone Reader | Slide Stainer | Gas Burner

억제환 측정기

Zone Reader



- 용도 : Inhibition Test, 역가시험
- 특징 : 시료와의 접촉 없이 완벽한 측정 가능

Maker	IUL (Spain)
제품명	Haloes Caliper
화면	디지털 디스플레이
측정 범위	0 ~ 35 mm
해상도	100 µm
IQ/OQ	가능

자동 그람염색기

Slide Stainer



- 용도 : 그람 염색법 자동화
- 특징 : 20개의 Slide 동시 염색 및 10개 프로그램 설정 및 저장

Maker	IUL (Spain)
제품명	Polystainer
용량	20 Slide
시약 용기	4 개
옵션	Quick Drain System, Stainless Steel Container Tray
IQ/OQ	가능

균수측정기 자동화 장비

Robotic Colony Counter



- 용도 : 자동 균수 측정, 억제환 측정 시 패트리디쉬 이송용
- 특징 : 플레이트를 Flash & Go 로 가져가서 읽힘

Maker	IUL (Spain)
제품명	Plate Handler
용량	80~90개 플레이트
플레이트 직경	90 mm
속도	240 개 플레이트 / h
IQ/OQ	가능

가스버너

Gas Burner



- 용도 : 실험 기구의 화염 멸균
- 특징 : 일반가스 (소형가스) 사용가능, 조절 가능한 IR센서 감지 거리

Maker	WLD-TEC (Germany)
제품군	Fuego SCS
화염 온도	액화가스 : 1350 °C 천연가스 : 1300 °C
재질	Stainless Steel
옵션	Foot Switch, 루프 자동감지 가능

가스버너

Gas Burner



- 용도 : 미생물, 분자 생물학 실험의 안전버너
- 특징 : 접종루프, 비늘등의 멸균에 사용하는 경제적 모델

Maker	WLD-TEC (Germany)
제품명	Gasprofi 1 Micro
화염 온도	액화가스 : 1350 °C 천연가스 : 1300 °C
재질	Stainless Steel
옵션	Foot Switch

멸균용 버너

Gas Burner



- 용도 : Loop 멸균 시 사용
- 특징 : 5~10초 내에 1000 °C까지 가열, Warm-Up 시간 불필요

Maker	WLD-TEC (Germany)
제품군	SteriMax Smart
화염 온도	750 ~ 1000 °C
재질	멸균관 : 석영 외관 : Stainless Steel, Safety Glass
작동	비접촉식 IR 센서로 자동 시작

Tablet Tester | Disintegration Tester | Friability Tester

수동 정제시험기

Manual Tablet Tester



- 용도 : 정제의 다양한 물성 측정
- 특징 : 작동이 간편하며, Compact한 크기

Maker	Charles Ischi AG (Switzerland)
제품명	HC 6.2
측정	경도, 두께, 직경, 질량, 마손도
출력	장비에 직접 프린터를 연결하여 통계 보고서 출력
보정	인증된 블록으로 2분 안에 간단한 보정
IQ/OQ	가능

반자동 정제시험기

Semi Automatic Tablet Tester



- 용도 : 정제의 다양한 물성을 반자동으로 측정
- 특징 : 모듈 방식으로 측정하고자 하는 물성에 따라 확장 가능

Maker	Charles Ischi AG (Switzerland)
제품명	P-Series
측정	경도, 두께, 직경, 질량
출력	장비에 직접 프린터를 연결하여 통계 보고서 출력
보정	정제 종류 및 Lot No. 저장 관리 가능
IQ/OQ	가능

자동 정제시험기

Automatic Tablet Tester



- 용도 : 정제의 다양한 물성을 자동으로 측정
- 특징 : 모든 종류의 정제 측정 가능

Maker	Charles Ischi AG (Switzerland)
제품명	UTS 4.1 Touch
측정	경도, 두께, 장경, 단경, 질량
출력	장비에 직접 프린터를 연결하여 통계 보고서 출력
보정	정제 종류 및 Lot No. 저장 관리 가능
IQ/OQ	가능

붕해도기

Disintegration Tester



- 용도 : 대한약전 및 USP, EP 붕해시험법 수행
- 특징 : 자석 탈부착 형태의 간편한 시험 용기, 개별 제어 가능

Maker	Charles Ischi AG (Switzerland)
제품명	DISI-M
시험 용기	1, 2, 3, 4 구
사용 온도	상온 ~ 40 °C
속도	30 Strokes/min
IQ/OQ	가능

자동 붕해도기

Auto Disintegration Tester



- 용도 : 대한약전 및 USP, EP 붕해시험법 수행
- 특징 : 자동으로 실험 종료시간 측정, 개별 제어 가능

Maker	Charles Ischi AG (Switzerland)
제품명	DISI-A
시험 용기	1, 2, 3, 4 구
사용 온도	상온 ~ 40 °C
속도	30 Strokes/min
IQ/OQ	가능

마손도기

Abrasion and Friability Unit



- 용도 : 정제의 마손도 측정
- 특징 : 대한약전 및 USP, EP 붕해시험법에 적합

Maker	Charles Ischi AG (Switzerland)
제품명	AE-1, AE-2
드럼	1, 2 개
속도	10 ~ 99 rpm
작동 시간	1 min ~ 24 hr
IQ/OQ	가능

Refractometer | Density Meter | Polarimeter

자동 굴절계 Automatic Refractometer



- 용도 : 빛에 대한 물질의 굴절률을 이용하여 용액의 농도 측정
- 특징 : 터치스크린 방식으로 간편한 작동

Maker	SCHMIDT+HAENSCH (Germany)
제품명	VariRef (C, B, A)
측정 범위	1.29000 - 1.58000 RI / 100% Brix(B)
해상도	0.000001 RI / 0.01% Brix(A)
정밀도	± 0.00002 RI / ± 0.02% Brix(ALL) [Standard conditions (589 nm, ts=20°C, tA=23°C)]
재현성	± 0.000005 RI / ± 0.006% Brix(A)

ABBE 굴절계 ABBE Refractometer



- 용도 : 빛에 대한 물질의 굴절률을 이용하여 수용액의 농도 측정
- 특징 : 간편한 조작과 소량의 샘플로 측정 가능

Maker	SCHMIDT+HAENSCH (Germany)
제품명	AR-12
측정 범위	1,3000 ~ 1,7000 RI, 0 ~ 95 % Brix
해상도	0.0002 RI, 0.1 % Brix
정밀도	±0.0002 RI, ±0.1 % Brix
재현성	0.0002 RI, 0.1 % Brix

밀도측정기 Density Meter



- 용도 : 액체의 밀도 측정
- 특징 : 터치스크린 방식으로 간편한 작동

Maker	SCHMIDT+HAENSCH (Germany)
제품명	EDM 5000
측정 범위	0 ~ 3 g/cm³
해상도	0.00001 g/cm³
정밀도	EDM 5000 : ±0.00005 g/cm³
재현성	EDM 5000 : ±0.00002 g/cm³

선광계 Polarimeter



- 용도 : 제약 원료 등의 비선광도를 측정
- 특징 : 샘플튜브 온도조절 (펄티어방식)

Maker	SCHMIDT+HAENSCH (Germany)
제품명	Unipol 2020
측정 파장	589 nm 외 (LED Lamp)
측정 범위	±360° / ±259°Z
해상도	0.001° / 0.01°Z
정밀도	±0.005° / ±0.02°Z

디지털 자동 선광계 Automatic Circle Polarimeter



- 용도 : 제약 원료 등의 비선광도를 측정
- 특징 : 온도 및 파장 자동조절 가능
5인치 터치스크린

Maker	SCHMIDT+HAENSCH (Germany)
제품명	VariPol C
측정 파장	405, 589 nm (LED Lamp)
측정 범위	±90° / ±259°Z
해상도	0.001° / 0.01°Z
정밀도	±0.01° / ±0.03°Z

당 분석기 Polarimeter

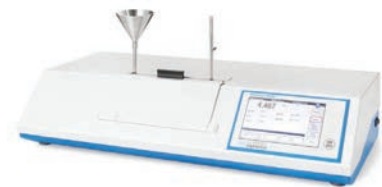

- 용도 : 제약 원료 등의 비선광도를 측정
- 특징 : 샘플튜브 온도조절 (펄티어방식)

Maker	SCHMIDT+HAENSCH (Germany)
제품명	Saccharomat Touch
측정 파장	587, 882 nm
측정 범위	-35°Z to +105°Z
해상도	0.01°Z
정밀도	±0.01°Z

pH Meter | Conductivity Meter | DO Meter

탁상용 pH 측정기

Benchtop pH Meter



- 용도 : pH 및 ORP 측정
- 특징 : 10개 센서로 각 센서에 대해 10개의 개별 캘리브레이션 결과를 저장 가능

Maker	OHAUS (USA)
제품명	Starter 5000
측정 범위	-2.000 ~ 20.000 pH -2000.00 ~ +2000.00 mV -30 °C ~ 130 °C
보정	1-9 Points
출력	USB, RS232
IP 등급	IP54
IQ/OQ	가능

탁상용 pH 측정기

Benchtop pH Meter



- 용도 : pH 및 ORP 측정
- 특징 : 정밀한 pH 측정, 직관적인 작동법으로 간편한 사용 가능

Maker	OHAUS (USA)
제품명	Starter 3100
측정 범위	-2.00 ~ 16.00 pH -1999 ~ +1999 mV -30 °C ~ 130 °C
보정	3 Points
IP 등급	IP54
IQ/OQ	가능

탁상용 전도도 측정기

Benchtop Conductivity Meter



- 용도 : 전도도, TDS, 염분 측정
- 특징 : 표준 전도도 측정 및 직관적인 작동법으로 간편한 사용 가능

Maker	OHAUS (USA)
제품명	Starter 3100C
측정 범위	00.0 µS/cm ~ 199.9 mS/cm 0.1 mg/L ~ 199.9 g/L (TDS) 0.00 ~ 19.99 psu (Salinity) 0 °C ~ 100 °C
보정	1 Points
IP 등급	IP54
IQ/OQ	가능

휴대용 pH 측정기

Portable pH Meter



- 용도 : 휴대용 pH 측정기
- 특징 : 경제적인 가격과 유지보수가 용이한 휴대용 pH 측정기

Maker	OHAUS (USA)
제품명	Starter 300
측정 범위	0.00 ~ 14.00 pH -1999 ~ +1999 mV 0 °C ~ 100 °C
보정	3 Points
배터리	AAA 전지 4개 (500시간 작동)
IP 등급	IP54

휴대용 DO 측정기

Portable DO Meter



- 용도 : 휴대용 DO 측정기
- 특징 : 경제적인 가격과 유지보수가 용이한 휴대용 DO 측정기

Maker	OHAUS (USA)
제품명	Starter 400D
측정 범위	0.0 ~ 200.0 % 0.00 ~ 20 mg/L (ppm) 0 ~ 50 °C
보정	1 or 2 Points
배터리	AAA 전지 4개 (500시간 작동)
IP 등급	IP54

휴대용 펜 미터

Portable Pen Meter



- 용도 : pH, ORP, DO, TDS, 온도 측정 등
- 특징 : 작고 경제적인 펜 미터로 간편하고 빠른 사용 가능

Maker	OHAUS (USA)
제품명	Starter Pen Meter
pH	0.00 ~ 14.00 pH
전도도	0 ~ 1999 µS/cm
온도 범위	0.0 ~ 99.0 °C
IP 등급	IP67

COD Meter | BOD Meter | Ammonia Meter | Water Analyzer

화학적 산소 요구량 측정기

COD Meter



- 용도 : 화학적 산소 요구량 측정
- 특징 : 원터치 방식의 전극으로 간편 사용

Maker	CKC (Japan)
제품군	HC-607
측정 방법	산성법 (Acid Method) 측정
측정 범위	10 ~ 1,000 mg/L (7개 범위)
재현성	± 2 %
외부 출력	RS-232 데이터 저장 및 출력 지원

생물학적 산소 요구량 측정기

BOD Meter



- 용도 : 생물학적 산소 요구량 측정
- 특징 : 신속, 간단한 BOD 측정 (60분 내 가능)

Maker	CKC (Japan)
제품군	α-5000
측정 방법	바이오펜서
측정 범위	2 ~ 50 mg/L
재현성	± 5 %
외부 출력	프린터 기본 제공

암모니아 측정기

Ammonia Meter



- 용도 : 암모니아성 질소, 암모늄이온 측정
- 특징 : 신속한 측정 시간, 교정이 필요없어 간편하게 사용 가능

Maker	CKC (Japan)
제품군	AT-2000
측정 방법	전량적정법
측정 범위	0 ~ 200 mg/L (시료 양에 따라 다름)
재현성	± 3 %
외부 출력	RS-232 데이터 저장 및 출력 지원

수질분석용 분광광도계

Spectrophotometer UV/VIS



- 용도 : Smart Photometry 원리로 수질측정
- 특징 : 10.1인치 대형 HD 터치스크린 간편하고 정확한 수질분석 가능

Maker	Macherey-Nagel (Germany)
제품명	NANOCOLOR UV/VIS II
파장범위	190 nm ~ 1,100 nm
Bandwidth	< 2 nm
광원	할로겐램프 (VIS), D2 (UV)
파장보정	자동
파장조절	0.1 nm
측정모드	200개 이상 Method 자동선택

수질분석용 히팅블럭

Heating Blocks for Digestion



- 용도 : 수질실험 전처리용
- 특징 : COD, T-N, T-P 실험 30분 이내 가능

Maker	Macherey-Nagel (Germany)
제품명	NANOCOLOR Vario 4
측정온도	40 °C ~ 160 °C (1 °C Increments)
온도안정성	± 1 °C
디스플레이	칼라 Touch 방식
승온시간	상온에서 160 °C 까지 약 10분 이내
샘플처리량	2 Block x 12 Holes for 16 mm Test Tube

휴대용 분광광도계

Portable Photometer



- 용도 : 휴대용 분광광도계
- 특징 : 현장에서 100개 이상 수질항목 측정 가능

Maker	Macherey-Nagel (Germany)
제품명	NANOCOLOR PF-12 Plus
파장범위	345 / 436 / 470 / 540 / 585 / 620 / 690 nm / 860 nm LED for NTU Measurement
광원	Xenon lamp
방수방진등급	IP 68
메모리	1,000개 데이터 저장

Glove | Mask | Sterile Sampling Bag

라텍스 글러브

Latex Glove



- 용도 : 미생물, 바이오 등의 실험에서 실험자 보호
- 특징 : 천연 고무 라텍스로 우수한 탄성과 편안한 착용감 제공

Maker	Medicom (Canada)
크기	XXS, XS, S, M, L, XL
길이	240, 300 mm
색상	아이보리
포장	100/Box, 10Boxes/Carton

니트릴 글러브

Nitrile Glove



- 용도 : 화학 실험에서 실험자 보호
- 특징 : 니트릴 재질로 단백질 알러지 문제 최소화, 우수한 내화학성

Maker	Medicom (Canada)
크기	XS, S, M, L, XL
길이	230, 235, 240, 290 mm
색상	흰색, 파란색
포장	100/Box, 10Boxes/Carton

마스크

Safe Mask



- 용도 : 교차 감염 예방
- 특징 : 탁월한 보호력 및 편안한 착용감, 우수한 방수력

Maker	Medicom (Canada)
재질	부직포
길이	175, 190 mm
색상	보라, 분홍, 흰색, 노랑, 파랑, 초록
포장	50/Box, 10Boxes/Carton

멸균 샘플백

Sampling Bag



- 용도 : 액체 및 고체 시료의 운송 및 보관
- 특징 : 가장 보편적으로 사용되는 다용도 멸균 샘플백

Maker	LABPLAS (Canada)
제품명	TWIRL'EM Sterile Sampling Bag
용량	60 mL ~ 1,650 mL
크기	76 x 178 ~ 254 x 382 mm
포장	cs/500 ea x 2, cs/1,000
특징	고객이 원하는 사이즈 제작 가능

스토마커용 멸균 필터백

Filter Bag



- 용도 : 식품 시료의 전처리 시 스토마커 백으로 사용
- 특징 : 멸균백 내부에 필터가 있어 시료 채취 후 별도의 여과 작업이 필요 없음

Maker	LABPLAS (Canada)
제품명	Filtra-Bag
용량	710 mL ~ 12 L
크기	152 x 229 ~ 381 x 508 mm
포장	100 ea x 2 cs, 100 ea x 4 cs
특징	고객이 원하는 사이즈 제작 가능

스탠드업 멸균 샘플백

Stand-Up Bag



- 용도 : 액체 및 고체 시료의 운송 및 보관
- 특징 : Stand-Up 형태

Maker	LABPLAS (Canada)
제품명	Stand-Up Bag
용량	400, 710 mL
크기	114 x 229 ~ 150 x 229 mm
포장	500 ea x 2 cs
특징	고객이 원하는 사이즈 제작 가능

Cleanroom Wipes | Gamma Wipes



Berkshire는 40년 이상 클린룸 액세서리를 제조해 온 글로벌 리더입니다. Berkshire 에서 생산되는 모든 제품은 바이오필드, 제약, 반도체, 광학, 전기전자 분야에서 다양하게 활용 가능합니다. 레보딕스에서 독점 공급하는 뛰어난 품질의 오염 방지 제품을 만나보세요.

클린룸 와이퍼

Cleanroom Wipes



- 용도 : 다양한 산업군에서 사용 가능한 범용 와이퍼
- 특징 : 경제적인 가격으로 효과적으로 오염 물질 제거가 가능

Maker	Berkshire (UK)
제품명	Supra Wipe 1
구성	Knitted
ISO Class	3-5
재질	Polyester
EDGE	Sealed Edge
포장	150pcs x 14 packs

클린룸 와이퍼

Cleanroom Wipes



- 용도 : ISO Class 3 이상의 실험실에서 사용 가능한 오염제거 와이퍼
- 특징 : 오염물질 제거 능력 탁월, 뛰어난 내마모성과 화학물질 호환성을 가지고 있음

Maker	Berkshire (UK)
제품명	Choice NW 600
구성	Nonwoven
ISO Class	5-8
재질	Cellulose/Polyester Blend
EDGE	Knife-Cut
포장	300pcs x 10 packs

멸균와이퍼

Gamma Wipes



- 용도 : ISO Class 5 이상의 실험실에서 사용 가능한 오염제거 와이퍼
- 특징 : 10-6 감마선 조사를 거친 후 출고되는 제품 일반 멸균실험실에서 다양하게 사용 가능

Maker	Berkshire (UK)
제품명	Gamma Wipe 67
구성	Nonwoven
ISO Class	5-8
재질	Cellulose/Polyester Blend
EDGE	Knife-Cut
포장	20pcs x 80 packs

멸균와이퍼

Gamma Wipes



- 용도 : ISO Class 3 이상의 실험실에서 사용 가능한 오염제거 와이퍼
- 특징 : 10-6 감마선 조사를 거친 후 출고되는 제품. 이소프로필 알코올, 페놀, 표백제 및 4 차 암모늄 화합물을 포함한 일반적인 세척 및 소독 용액과 화학적으로 호환가능

Maker	Berkshire (UK)
제품명	Gamma Wipe VP
구성	Knitted
ISO Class	3-5
재질	Polyester
EDGE	Ultrasonically Sealed
포장	20pcs x 40 packs

REVODIX

레보덱스(주)

레보덱스(주) 홈페이지에 방문하시면 더욱 다양한 제품을 만나보실 수 있습니다
www.revodix.co.kr | sales@revodix.co.kr

본 사

(12930) 경기도 하남시 조정대로 150 (덕풍동)
하남지식산업센터 ITECO 334호
| TEL 031-790-1907 | FAX 031-790-1908 |

대전지사

(34016) 대전광역시 유성구 테크노3로 65 (관평동)
한신에스메카 415호
| TEL 042-824-5167/8 | FAX 042-824-5169 |

오송사무소

(28576) 충청북도 청주시 흥덕구 공단로 134 (송정동)
세종테크노밸리 1012호
| TEL 070-7835-1344 | FAX 070-7835-8090 |

