



Medical



Dental



Industrial

2018

www.medicom.com

Tel : 02 393 7105

Email : sales@medicom-korea.com

www.medicom.com

CONTENTS

	CONTENTS	1
	ABOUT MEDICOM	2
	GLOVES	3
	VINYL GLOVES	4
	LATEX GLOVES	5
	RE-USABLE GLOVES	7
	NITRILE GLOVES	8
	MASKS	10
	APPAREL	16
	STERILIZATION	20
	OTHERS	22



ABOUT MEDICOM 메디콤

Medicom 회사소개

Medicom은 전 세계 95개국에 의료와 감염관리 용품을 생산, 유통하고 있는 핵심 **글로벌 헬스케어 기업**으로 의료, 치과, 산업, 동물병원 및 연구소에 감염관리를 위한 일회용 예방 제품과 사용자의 환경 개선을 위한 다양한 용품의 개발과 공급에 최선을 다하고 있습니다. 또한 Medicom은 다양한 의료 환경 가운데 의료인과 환자에게 최상의 결과를 제공하기 위한 최선의 제품을 공급함으로써 전 세계적인 신뢰를 꾸준히 쌓아가고 있습니다.

앞으로도 Medicom 제품을 사용하는 모든 사용자들이 안전한 작업환경을 구축할 수 있도록 최선을 다할 것이며,

감염관리 제품 전문 기업으로서 사용자가 최고의 결과를 경험할 수 있도록 끊임없이 노력하는 기업이 될 것임을 약속드립니다.

Medicom 약력

- 1988년 캐나다에 설립, 감염관리 제품에서 선도하는 회사입니다.
- 높은 품질의 감염관리 전문 제품을 제조하고 유통합니다.
- 현재 의료 일회용품 핵심 공급자 중 하나로 전 세계적으로 알려져 있습니다.
- 전 세계 5대륙 95개 국가에서 Medicom 제품을 사용하고 있습니다.
- Medicom 제조시설 - 미국, 네덜란드, 프랑스, 중국, 대만, 말레이시아
- ISO, FDA, CD, EN, ASTM 등 국제적인 기준에 충족한 제품을 생산합니다.
- Medicom 아시아 지점 : 홍콩(아시아 본부), 일본, 중국, 대만, 말레이시아, 호주, 한국, 싱가포르

ABOUT GLOVES



비닐

원료	폴리 비닐 클로라이드
장점	단백질 알러지 문제없음 경제적
신축성	● ● ● ● ●
착용감	● ● ● ● ●
인장강도	● ● ● ● ●
파열강도	● ● ● ● ●
내화학성	● ● ● ● ●

라텍스

원료	천연 고무 라텍스
장점	우수한 탄성력 편안한 착용감
신축성	● ● ● ● ●
착용감	● ● ● ● ●
인장강도	● ● ● ● ●
파열강도	● ● ● ● ●
내화학성	● ● ● ● ●

니트릴

원료	아크릴 니트릴 & 부타디엔
장점	단백질 알러지 문제없음 우수한 내화학성
신축성	● ● ● ● ●
착용감	● ● ● ● ●
인장강도	● ● ● ● ●
파열강도	● ● ● ● ●
내화학성	● ● ● ● ●



일회용
사용



무분말



식품용



내화학성
EN374



매끄러운
표면



전체
텍스처



손가락
텍스처



라텍스 프리

Medicom® Gloves Dispenser

제품설명 :

- 3중 투명 아크릴 재질
- 견고하고 튼튼한 디자인
- 100&200pcs 글러브 패키지 모두 사용 가능
- 다양한 장소 설치 가능

Item# MEDGLDP492

Size 440mm x 98mm x 250mm

Colour 투명

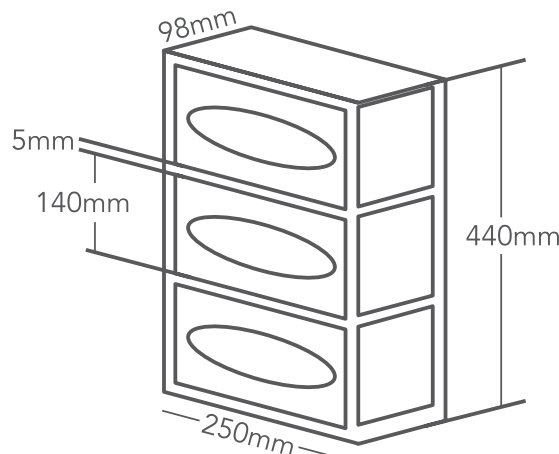



VINYL/CPE

Vitals® Vinyl Gloves

제품설명 :

- 다목적용 사용 가능
- 매끄러운 표면처리로 편안한 착용감
- 100% 라텍스 프리, 천연고무 라텍스 장갑에 민감한 사용자에게 적합

Item#	VITGP1209	Powder Free
Size	XS S M L XL	
Colour	투명	



100 pcs/box 10 boxes/carton



Vitals® Blue Vinyl Gloves

제품설명 :

- 다목적용 사용 가능
- 매끄러운 표면처리로 편안한 착용감
- 100% 라텍스 프리, 천연고무 라텍스 장갑에 민감한 사용자에게 적합

Item#	VITGP1309	Powder Free
Size	S M L XL	
Colour	파란색	



100 pcs/box 10 boxes/carton



Vitals® Clear Comfort CPE Gloves

제품설명 :

- 일반 폴리 장갑보다 편안하고 뛰어난 보호 기능
- 전체 표면 텍스처로 미끄러운 물건
- 식품 취급, 일반 청소 및 빈번하게 장갑을 교체하는 사용자에게 적합
- 100% 라텍스 프리, 천연고무 라텍스 장갑에 민감한 사용자에게 적합

Item#	VITGC1210	Powder Free
Size	S M L	
Colour	투명 Length ≥ 270mm	



100 pcs/box 10 boxes/carton



LATEX GLOVES

Vitals® Easy Fit | Latex Single Use Gloves

제품설명 :

- 매끄러운 표면처리
- 다목적용 사용 가능
- 천연 라텍스 재질

Item# **VITHL1212** Powder Free

Size XS S M L XL

Colour 아이보리 | Length ≥ 240mm

100 pcs/box 10 boxes/carton



SafeBasics® Easy Fit | Latex Gloves

제품설명 :

- 뛰어난 민감도와 탁월한 신축성
- 표면 전체 텍스처, 초소형 사이즈(XXS) 가능
- 우수한보호기능과그립감

Item# **SFBGL1188** Powder Free

Size XXS XS S M L XL

Colour 아이보리 | Length ≥ 240mm

100 pcs/box 10 boxes/carton



SafeTouch® Ultra Grip | Latex Textured Gloves

제품설명 :

- 우수한 작업감, 뛰어난 신축성과 편안한 착용감
- 인체공학 디자인으로 손의 피로감 완화
- 표면 전체 텍스처, 초소형 사이즈(XXS) 가능

Item# **SFTGL1122** Powder Free

Size XXS XS S M L

Colour 아이보리 | Length ≥ 240mm

100 pcs/box 10 boxes/carton



SafeTouch® Extend | Latex Extended Cuff Gloves

제품설명 :

- 다목적용 글러브로 보호력 우수
- 매끄러운 표면처리로 민감도 뛰어남
- 편안한 착용감

Item# **SFTHL1231** Powder Free

Size S M L XL

Colour 아이보리 | Length ≥ 300mm

100 pcs/box 10 boxes/carton





DisTech™ | Latex Gloves

제품설명 :

- 탁월한 그립감
- 뛰어난 민감도와 신축성
- 표면 전체 텍스처, 세밀한 작업용이

Item#	DT1124	Powder Free		
Size	XS	S	M	L
Colour	아이보리			

100 pcs/box 10 boxes/carton



SafeTouch Scentsation Bubble gum Glover | Latex Gloves

제품설명 :

- 딸기향 라텍스 글러브
- 편안한 착용감
- 우수한 그립감

Item#	SFT1118	Powder Free		
Size	XS	S	M	L
Colour	분홍색	Length ≥ 230mm		

100 pcs/box 10 boxes/carton



SafeTouch Scentsation Bubble gum Glover | Latex Gloves

제품설명 :

- 풍선껌향 라텍스 글러브
- 편안한 착용감
- 우수한 그립감

Item#	SFT1120	Powder Free		
Size	XS	S	M	L
Colour	파란색	Length ≥ 230mm		

100 pcs/box 10 boxes/carton



RE-USABLE GLOVES

SafeGrip® Foam Nitrile Coated Gloves

제품설명 :

- 맨손과 같은 촉감과 정밀성
- 땀은 방출, 공기는 유입되는 우수한 통밀성
- 가볍고 편안한 착용감으로 손의 피로 감소
- 편안한 착용감으로 손의 피로 감소
- 유수분 조건에서도 우수한 그립감 유지
- EN388:4121 기준 충족

Item# **SAGGN1152**

Size Large (SIZE 9)

Colour 검정색



12 pairs/box 20 boxes/case



Vitals® Household Re-usable Gloves

제품설명 :

- 미끄럼 없는 고무장갑
- 편안한 착용감
- 위생 산업 및 식품 제조소 또는 가정용
- 따뜻한 물에 닿아도 끈적이지 않음

Item# **VITHL1151**

Size M L

Colour 빨간색 | Length ≥ 310mm



12 pairs/box 10 boxes/carton



Vitals® Industrial Re-Usable Gloves

제품설명 :

- 미끄럼 없는 고무장갑
- 락스 사용 시에도 안전하게 손을 보호
- 위생산업 및 일반산업용
- BS EN 16523-1:2015 충족 (480분 염소 침적에도 변형 없음)

Item# **VITHL1150**

Size M L XL

Colour 검정색 | Length ≥ 350mm



12 pairs/box 10 boxes/carton



NITRILE GLOVES

Vitals® True Fit Thin | Blue Textured Nitrile Gloves

제품설명 :

- 향상된 내구력
- 편안한 착용감
- 다양한 분야 적용

Item# **VITTN1197** Powder Free
 Size S M L XL
 Colour 파란색 | Length ≥ 240mm



100 pcs/box 10 boxes/carton



SafeTouch® Advanced Platinum/Slim | Nitrile Gloves

제품설명 :

- 무알러지제품 (Accelerator 무첨가)
- 탁월한 내화학성
- 우수한 내구력
- 라텍스처럼 유연하고 편안한 착용감

Item# **SFT0Y1174 SFT0Y1175** Powder Free
 Size XS S M L XL
 Colour 흰색 파란색 | Length ≥ 235mm

EcoChoice
 친환경적 패키지
 200pcs/pack 가능



100 pcs/box 10 boxes/carton



SafeTouch® Advanced Force | Textured Blue Nitrile Gloves

제품설명 :

- 향상된 내구력
- 우수한 그립감

Item# **SFTAN1220** Powder Free
 Size S M L XL
 Colour 파란색 | Length ≥ 230mm

**20%
 보호력 증대**
 GREATER PROTECTION



100 pcs/box 10 boxes/carton





SafeTouch® Advanced Pro | Nitrile Gloves (Long Cuff)

제품설명 :

- 연장된 손목 부분 (290mm)
- 고위험 화학물질 또는 오염물질 취급자를 위한 보호 기능 강화
- 탁월한 내마모성과 견고함

Item#	SFTGN1131					Powder Free
Size	XS	S	M	L	XL	
Colour	보라색					Length ≥ 290mm



100 pcs/box 10 boxes/carton



SafeTouch® Advanced Guard | Nitrile Gloves

제품설명 :

- 우수한 내화학성과 내마모성
- 편안하고 뛰어난 보호 기능
- 손가락 텍스처, 뛰어난 그립감
- 인체공학 디자인으로 손의 피로감 완화

Item#	SFTGN1136	SFTGN1138	Powder Free	
Size	XS	S	M	L
Colour	파란색	검정색	Length ≥ 240mm	



100 pcs/box 10 boxes/carton



Vulcan® Nitrile Gloves | Retail Pack

제품설명 :

- 뛰어난 내화학성
- 자동차 정비, 유해화학물질 취급자, 식품 취급 등 다양한 용도 사용 가능
- 유수분 조건에서도 우수한 그립감 유지

Item#	VULA461318R		Powder Free
Size	Large		
Colour	남색		
	Length ≥ 240mm		



10 pcs/box 100 boxes/carton



ABOUT MASK



일회용 사용



라텍스 프리



끈타입



밴드타입



미국 국립 산업 안전보건 연구원
NIOSH 인증

Vitals® Black Earloop Mask

제품설명 :

- 편안한 호흡을 위한 부드럽고 가벼운 재질
- 실끈 밴드로 쾌적한 착용감
- 알루미늄 와이어 코편으로 높은 고정력



Item# VITGMK2792

Colour 검정색

50 pcs/box 10 boxes/carton



AccuFit® Earloop Mask | 2 ply

제품설명 :

- 2중 필터 마스크
- 우수한 통기성, 편안한 호흡 용이
- 보다 넓은 와이어 코편으로 고정 편리

Item# ACF0002414

Colour 흰색

100 pcs/box 20 boxes/carton





SafeMask® Premier Plus Sof-Skin Earloop Mask

제품설명 :

- ASTM F level 1, 부드럽고 가벼운 질량의 고성능 마스크
- 피부가 예민한 사용자에게 적합
- 염료를 사용하지 않고 부드러운 이너레이어 촉감
- 산뜻한 느낌의 착용감
- 보풀 발생 없음
- BFE 95% 초과 충족 (3um)
- PFE 95% 초과 충족 (0.1um)



Item# **SFS0002330**

Colour

50 pcs/box 10 boxes/carton



AccuFit® Earloop 1-ply Earloop Mask

제품설명 :

- 경제적인 1겹 안면 마스크
- 산업용 사용자 적합
- 우수한 통기성



Item# Colour

MED0002514

MED0002515

100 pcs/box 20 boxes/carton



SafeMask® Procedure Child Earloop Mask

제품설명 :

- 7세이상 어린이용 마스크
- 민감피부 전용 비라텍스 재질
- 길이 14.5cm

Item# Colour

MED2115KID

MED2116KID

50 pcs/box 10 boxes/carton





SafeMask® Premier Earloop Mask | 3 ply

제품설명 :

- 탁월한 보호력 및 편안한 착용감으로 마스크를 매일 착용해야 하는 사용자에게 적합
- 부직포 재질의 필터와 주름 형태로 액체 투과 방지 및 교차감염 예방 가능
- 우수한 방수성
- 부드러운 재질과 탁월한 보호력
- 당김이 없는 이어밴드
- 알루미늄 와이어 코편

Item#	Colour	Item#	Colour
PMR002011M	보라색	PMR002016M	분홍색
PMR002014M	흰색	PMR002017M	노란색
PMR002015M	파란색	PMR002018M	초록색



50 pcs/box | 10 boxes/carton



175mm, 190mm
두가지 사이즈 가능

SafeMask® Individual Earloop Mask Pack (Multicolor)

제품설명 :

- 6가지의 다양한 색상 패키지
- 개별 포장으로 위생적이며, 외출 시 휴대용으로 편리함
- 부직포 재질의 필터와 주름 형태로 액체 투과 방지
- 우수한 방수성

Item#	PMR0002120
Colour	파란색 노란색 보라색 분홍색 초록색 흰색



6 pcs/pack | 10 packs/box | 10 boxes/carton



SafeMask® Individual Kids Mask

제품설명 :

- 부드럽고 가벼운 소재로 흡기성과 작은 얼굴에 착용하기 적합
- 개별 포장으로 위생적이며, 외출 시 휴대용으로 편리함
- 실끈 밴드로 쾌적한 착용감
- 알루미늄 와이어 코편으로 높은 고정력

Item#	SFMHMK2331
Colour	파란색



40 pcs/box | 12 boxes/carton





SafeMask® Tie-On Surgical Mask

제품설명 :

- ASTM F level 1, 끈으로 묶는 타입의 수술 마스크
- 적절한 보호 효과와 편안한 착용감의 디자인
- 체액이나 혈액 등 진료 중 발생하는 액체를 완벽하게 차단하여 교차감염예방
- BFE 95% 초과 총족 (3um)
- PFE 95% 초과 총족 (0.1um)

Item# MED002000B

Colour 파란색



50 pcs/box 6 boxes/carton



SafeMask® Anti-Fog Tie-On Mask

제품설명 :

- 끈으로 묶는 최상의 편안함과 부드러운 감촉의 마스크
- 매일 마스크를 사용하는 사용자를 위한 탁월한 선택
- 이너레이어는 피부자극을 발생시키지 않는 재질로 구성
- 김서림 방지 기능의 이너레이어 디자인으로 안경을 착용하는 사용자에게 적합
- BFE 95% 초과 총족 (3um)
- PFE 95% 초과 총족 (0.1um)

Item# SFSH2050BF

Colour 파란색



50 pcs/box 6 boxes/carton



Dr.Guard White Mask

제품설명 :

- 3중 필터
- 알루미늄 코지시대
- 편안한 이어밴드
- 위생적인 날개 포장

Item# DCMJMA2383

Colour 흰색



30 pcs/box 20 boxes/carton



SafeMask® Protective Eyewear

제품설명 :

- 액체(혈액, 체액)이 튀 수 있는 작업 중 추가적인 보호를 위한 안경
- 눈과 얼굴을 감싸는 디자인, 김서림방지 렌즈는 우수한
- 보호기능 및 명확한 가시성 제공
- 인체공학적 디자인으로 장시간 착용에도 피로하지 않음

Item# **MED0002900**

Colour

10 pcs/box 6 boxes/carton



SafeMask® Full Face Shield

제품설명 :

- 안면과 목부분 전체를 보호할 수 있는 길이
- 감염예방 효과
- 머리밴드부분이 잘 봉합되어 있어 외부의 공기로 부터 안전하게 보호
- 마스크 착용시 보호 효과 증대
- 김서림이 발생하지 않아 가시력 확보

Item# **MED0002033**

Colour

24 pcs/box 6 boxes/carton



SafeMask® Premier Pro-Shield Mask

제품설명 :

- ASTM level 3, 밴드형/끈으로 묶는 쉴드 마스크
- 전체 안면 보호효과
- 김서림이 발생하지 않아 가시력 확보
- 레이저 시술 또는 유해한 미립자 발생 시 착용
- BFE 98% 초과 충족 (3um)
- PFE 98% 초과 충족 (0.1um)

Item# Colour

MED0002025

MED0002026

25 pcs/box 4 boxes/carton





SafeMask® Cone Mask

제품설명 :

- 알루미늄 와이어 코편으로 높은 고정력과 모양 조정이 용이
- 우수한 신축성의 편안한 헤어밴드
- 부드럽고 자극이 없는 소재와 형태로 제조

Item# **MED0002020**

Colour 파란색

50 pcs/box 10 boxes/carton



SafeMask® N95 Respirator

제품설명 :

- NIOSH 인증 마스크
- 콘 모양으로 95%의 필터 여과효율 및 액체 저항성 우수
- 넓은 내부 공간과 가벼운 소재, 부드러운 안감 처리로 편안한 착용감과 통기성

Item# **MED0002321**

Colour 흰색

20 pcs/box 8 boxes/carton



AMD® Flat Fold Duckbill N95 Respirator

제품설명 :

- NIOSH 인증 마스크
- 오리 모양의 호흡기로 95%의 필터 여과효율 및 액체 저항성 우수
- 넓은 내부 공간과 가벼운 소재, 부드러운 안감 처리로 편안한 착용감과 흡기성

Item# **AMD0002320**

Colour 흰색

20 pcs/box 8 boxes/carton



Kolmi® N95/P2 Mask

제품설명 :

- FFP2 NR 등급의 방진마스크
- 독성, 고분자, 에어로졸 등 유해 성분으로부터의 보호
- 초음파 용접 방식으로 제조
- 넓은 내부 공간으로 편안한 호흡 가능, 프랑스 제조

Item# **KMI2010SBL KMI2010SPK KMI2010SWH KMI2010SYL**

Colour 파란색 분홍색 흰색 노란색

50 pcs/box 10 boxes/carton



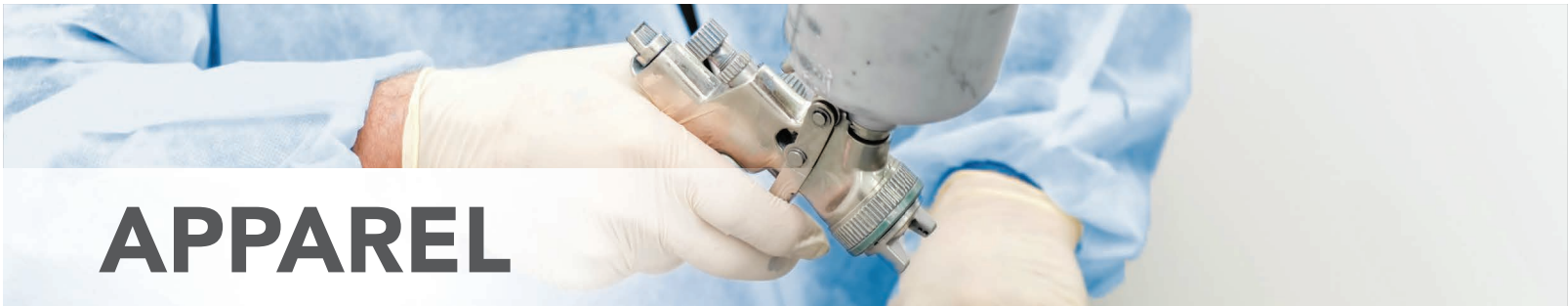

APPAREL

Medicom® Lab Gown Button Up

제품설명 :

- SMS 소재의 3중 필터 가운
- 편안한 착용감
- 우수한 방습성과 교차감염 예방
- 간편한 버튼 방식 착용, 목과 손목 니트 재질로 편안한 착용감

Item#	MED0008016	MED0008017	MED0008018	MED0008019
Size	Small	Medium	Large	X-Large

Colour 파란색

10 pcs/pack 5 packs/carton



Medicom® Isolation Gown Tie Back 30G

제품설명 :

- 30g 중량의 일회용 가운 (Spun bonded polypropylene)
- 높은 수준의 방습성과 교차감염 예방
- 니트 소재의 커프로 손목을 부드럽게 감싸줌
- 허리와 목부분의 매듭으로 사이즈 조절

Item#	MED0008023-30
Size	30g Spun bonded polypropylene.

Colour 파란색

10 pcs/pack 5 packs/carton



Medicom® Isolation Gown Tie Back 40G

제품설명 :

- 40g 중량의 일회용 가운 (Spun bonded polypropylene)
- 높은 수준의 방습성과 교차감염 예방
- 니트 소재의 커프로 손목을 부드럽게 감싸줌
- 허리와 목부분은 착용이 간편한 벨크로타입의 매듭

Item#	MED008023-40	MED008009-40
Size	40g Spun bonded polypropylene.	

Colour 파란색 노란색

10 pcs/pack 5 packs/carton



Medicom® Fluid Resistant Gown

제품설명 :

- 보호력 및 액체 저항성 증진으로 감염 위험이 높은 경우 사용 권장
- 니트 소재의 커프로 손목을 부드럽게 감싸줌
- 목부분은 착용이 간편한 벨크로타입의 매듭
- AAMI Level 2 기준 충족

Item#	MED008033-40
Size	30g Spun bonded polypropylene 10g Polyethylene

Colour 파란색

10 pcs/pack 5 packs/carton





Medicom® CoverAll Gown

제품설명 :

- 우수한 보호력: 미세먼지, 미세섬유, 윤활유 등의 유해물질 차단
- 폴리프로필렌 부직포 재질
- 탁월한 통기성과 높은 방수성
- 앞부분의 지퍼로 편안한 착용

Item# MED0008042

Size Large

Colour

10 pcs/pack 5 packs/carton



SafeBasics® Disposable Plastic Apron

제품설명 :

- 다용도 방수 에이프런
- 우수한 방수성
- 교차감염 예방

Item# SFBGGW5682 SFBGGW5683

Colour

100 pcs/box 10 boxes/carton



Medicom® PE Gown Individual Pack | With Sleeves

제품설명 :

- 비닐 가운
- 우수한 방수성, 교차감염 예방
- 위생적인 개별포장

Item# MED08023PE

Colour

1 pcs/pack 100 packs/carton



SafeBasics® Shoe Cover | Non-Skid

제품설명 :

- 신발 위에 덧대어 착용하는 보호장비
- 우수한 방수성
- 고무 밴드로 탈착 용이
- 미끄럼 방지 엠보싱 처리

Item# SFBGSC8007

Colour

100 pcs/box 3 boxes/carton





SafeWear® Surgical Gown Sterile

제품설명 :

- 일회용 수술가운 (AAMI Level 3 standard)
- 3중 Ultrasonic stitch : 체액 및 혈액에 대한 방수력
- 착용이 간편한 벨크로 타입의 목 매듭
- 가볍고 보풀이 발생하지 않는 재질

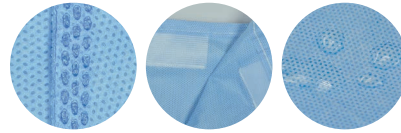

Item# 835C 835D 835E 835F 835G
 Size Medium Large X-Large XX-Large XXX-Large

Colour 파란색

50 pcs/pack 1 boxes/carton



STERILE EO

SafeWear® Surgical Cap

제품설명 :

- SMS 재질의 부드러운 촉감
- 통기성 및 내구력 우수
- 비라텍스

Item# SFWHCP8982

Colour 파란색

100 pcs/box 10 boxes/carton



SafeWear® High Performance Lab Coats /Hipster Jackets

제품설명 :

- 45g/m2 SMS 원단 사용
- 고성능 랩코트, 사용감이 편안함
- OSHA 액체저항 기준 충족
- 깔끔한 마감처리, 주머니 3개, 버튼 여밈 처리
- 다양한 색상 선택 가능
- 기능, 디자인, 편안한 착용감 조화

Size (S, M, L, XL, XXL)

Item# Colour

SFWA08107 진청색
 SFWA08108 분홍색
 SFWA08109 보라색
 SFWA08110 흰색
 SFWA08111 카키색
 SFWA08112 파란색

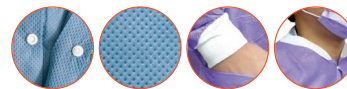
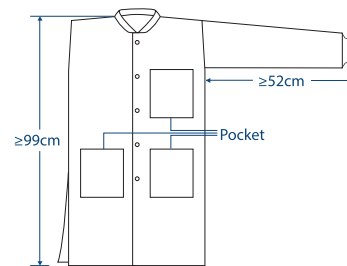

Item# Colour

SFWA08101 진청색
 SFWA08102 분홍색
 SFWA08103 보라색
 SFWA08104 파란색
 SFWA08105 흰색
 SFWA08106 카키색

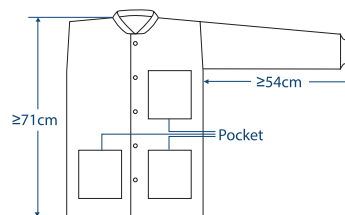

12 pcs/pack 5 packs/carton





SafeBasics® Clip Cap | 18" (47cm)

제품설명 :

- 편안한 착용감
- 비라텍스 헤어밴드로 알러지 반응 최소화
- 다양한 색상

Item# **SFBG8000B** **SFBG8000W**

Colour 파란색 흰색

100 pcs/box 10 boxes/carton



Medicom® Disposable Cap | 21" (53cm)

제품설명 :

- 폴리프로필렌(Polypropylene)소재의 고품질 헤드캡
- 부피가 작아 보관 용이
- 21인치의 넉넉한 크기
- 뛰어난 방수성
- 헤드밴드 부분은 비라텍스로 알러지 반응 최소화

Item# **MED008044B** **MED008044W**

Colour 파란색 흰색

100 pcs/box 10 boxes/carton



SafeBasics® Disposable Bouffant Cap | 21" (53cm)

제품설명 :

- 폴리프로필렌(Polypropylene)소재의 고품질 헤드캡
- 보풀이 발생하지 않는 소재
- 부드럽고 탄력있는 헤드밴드로 내구력이 강함
- 헤드밴드 부분은 비라텍스로 알러지 반응 최소화

Item# **SFBGCP8000** **SFBGCP8001**

Colour 흰색 파란색

100 pcs/box 5 boxes/carton



Medicom® Bibs With Ties

제품설명 :

- 뛰어난 방수성
- 목 부위를 묶는 타입의 에이프런

Item# **MED0DA8282**

Colour 파란색

100 pcs/pack 10 packs/carton





STERILIZATION

SafeSeal® Quattro | Self Sealing Sterilization Pouches

제품설명 :

- 경제적 : 인디케이터가 제품 내/외부에 위치
- 편의성 : 접착기 불필요
- 안정성 : 고성능의 의료 전용 종이 사용 (프랑스 제조)
- 열은 푸른색으로 코팅된 필름은 잘 찢어지거나 구멍이 난 경우 식별이 용이
- 종이와 필름을 분리할 때, 필름에 잔여물이 남지 않고 깔끔하게 분리됨
- 튼튼하고 넓은 접착 면
- 접착 면에 점선이 처리되어 정확하게 접어 봉합이 가능하며 멸균팩이 열리기 전까지 기구가 오염되지 않도록 보호
- 내부와 외부 인디케이터로 일반적 의류용 소독제와 호환되는 무연 고품질 의료 잉크 사용



Item#	Size	Quantity
SFQA880004	70mm x 229mm	6 boxes/carton
SFQA880054	89mm x 133mm	5 boxes/carton
SFQA880104	89mm x 229mm	6 boxes/carton
SFQA880154	57mm x 102mm	10 boxes/carton
SFQA880254	133mm x 254mm	10 boxes/carton
SFQA880304	191mm x 330mm	5 boxes/carton
SFQA880354	254mm x 356mm	5 boxes/carton
SFQA880404	305mm x 432mm	5 boxes/carton

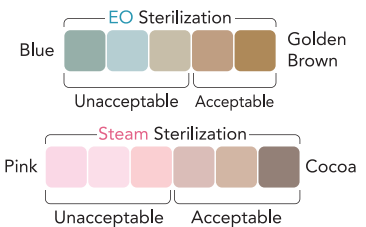

200 pcs/box



Medicom® Flat Sterilization Reels

제품설명 :

- 원하는 크기로 재단하여 기구들을 적재할 수 있어 시간과 비용 절약
- 편리한 디자인 패키지로 사용하는 동안 롤의 오염 최소화
- 특수한 중량의 종이를 사용하여 잘 찢기지 않음
- 색상 변화 인디케이터로 멸균 확인
- 스팀과 에틸렌옥사이드 멸균에 적합
- 200m 길이 제품의 다양한 사이즈

Item#	Size	Quantity
MED0009510	50mm x 200M	6 boxes/carton
MED0009520	75mm x 200M	4 boxes/carton
MED0009530	100mm x 200M	3 boxes/carton
MED0009540	150mm x 200M	2 boxes/carton
MED0009550	200mm x 200M	4 boxes/carton
MED0009560	250mm x 200M	4 boxes/carton
MED0009570	300mm x 200M	2 boxes/carton
MED0009580	350mm x 200M	2 boxes/carton



200 pcs/box





Medicom® Gusseted Sterilization Reels

제품설명 :

- 입체적인 디자인으로 내부 공간이 넓어 부피가 큰 기구를 멸균할 때 적합
- 원하는 크기로 재단하여 기구들을 적재할 수 있어 시간과 비용 절약
- 특수한 중량의 종이를 사용하여 잘 찢기지 않음
- 색상 변화 인디케이터로 멸균 확인
- 스티프과 에틸렌옥사이드 멸균에 적합
- 100m 길이 제품의 다양한 사이즈



Item#	Size	
TO91010	75mmx27mmx100m	8 rolls/carton
TO91020	100mmx52mmx100m	6 rolls/carton
TO91030	150mmx52mmx100m	4 rolls/carton
TO91040	200mmx57mmx100m	4 rolls/carton
TO91050	250mmx67mmx100m	2 rolls/carton
TO91060	300mmx82mmx100m	2 rolls/carton

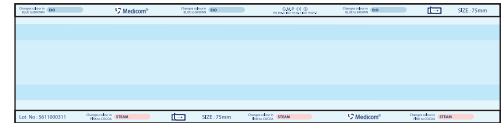

SafeBasics® Ster. Reels

제품설명 :

- ISO11140-1, ISO11607, AAMI 기준 충족
- 의료 전용 종이
- 다양한 사이즈
- 위생적이고 간편한 패키지



Item#	Size	
SFBGR75010	50mm x 200m	6 boxes/carton
SFBGR75020	75mm x 200m	4 boxes/carton
SFBGR75030	100mm x 200m	3 boxes/carton
SFBGR75040	150mm x 200m	2 boxes/carton
SFBGR75050	200mm x 200m	4 boxes/carton
SFBGR75060	250mm x 200m	4 boxes/carton



SafeSeal® Plasma Ster. Reels

제품설명 :

- 플라즈마 소독물 (Tyvek)
- ISO11140-1, ISO11607, AAMI 기준 충족
- 의료 전용 종이
- 다양한 사이즈
- 위생적이고 간편한 패키지



Item#	Size	
SSLGR70010	50mm x 200m	4 boxes/carton
SSLGR70020	75mm x 150m	4 boxes/carton
SSLGR70030	100mm x 150m	4 boxes/carton
SSLGR70040	150mm x 150m	4 boxes/carton
SSLGR70050	200mm x 150m	2 boxes/carton
SSLGR70060	250mm x 100m	2 boxes/carton
SSLGR70070	320mm x 100m	1 box/carton
SSLGR70080	430mm x 100m	1 box/carton
SSLGR70090	490mm x 100m	1 box/carton



OTHERS



Medicom® Gauze Swabs | 8 ply

제품설명 :

- 높은 흡수력
- 100% 순면
- 보풀이 일어나지 않도록 모서리 부분 접음 처리

Item#	MED0003001	MED0003003	MED0003005
Size	5cm x 5cm	7.5cm x 7.5cm	10cm x 10cm
	25 packs/carton	20 packs/carton	10 packs/carton



Cotton



200 pcs/pack

SafeBasics® Non-Woven Swabs | 4 ply

제품설명 :

- 코튼 재질을 대체할 수 있는 보다 경제적인 부직포 재질
- 무화학성분으로 알러지 반응 없음
- 비멸균 제품

Item#	SFBA002101	SFBA002103	SFBA002100
Size	5cm x 5cm	7.5cm x 7.5cm	10cm x 10cm
	25 packs/carton	20 packs/carton	10 packs/carton



Non-Woven



200 pcs/pack

SafeTouch® Medisorb All Purpose Non-Woven Towel

제품설명 :

- 고흡수력 다용도 타월
- 부드럽고 순한 촉감
- 오염된 작업대 혹은 장비의 빠른 표면 세정에 효과적

Item#	SFTGNW4033	SFTGNW4063
Size	35cm x 30cm	60cm x 35cm



Non-Woven

100 pcs/box 12 boxes/carton



SafeBasics® Disposable Underpad

제품설명 :

- 높은 흡습성을 가진 폴리머 방수 소재 패드
- 최대 350ml까지 흡수 가능
- 엠보싱 처리되어 있는 셀룰로스 섬유로 흡수된 액체의 분산을 더욱 활성화 함
- 견고하고 부드러운 부직포 층의 면으로 부드러운 접촉감
- 효율적인 위생관리를 위한 두터운 방수층

Item#	SFBGUL7164
Size	40cm x 60cm

10 pcs/pack 30 packs/carton





SafeTouch® Cleansing Mitts

제품설명 :

- 알로에 베라, 비타민 E, 비타민 B5 가 함유된 장갑
- 무취, 저자극 제품
- 작업량의 감소 및 재료 비용 절감 가능
- 전자레인지로 데운 후 사용 가능
- 부드러운 일회용 글러브로 편리하고 위생적인 용품



알로에베라
Vitamin E & B5



행금 불필요



고강도



전자레인지
사용가능



비자극성



Item# SFTHCM2621

Size 25cm x 16.5cm

8 pcs/pack 24 packs/carton



SafeTouch® Shampoo Cap

제품설명 :

- 간편하고 쉽게 뽑아쓸 수 있는 샴푸 캡
- 저자극성
- 알로에 베라, 비타민 E, 비타민 B5 가 함유된 캡
- 전자레인지로 데운 후 사용 가능
- 행금 불필요



알로에베라
Vitamin E & B5



비자극성



전자레인지
사용가능



행금 불필요



Item# SFT0102103

1 pcs/pack 24 packs/carton



Medicom® Pre-Moistened Washcloth

제품설명 :

- 보습 물티슈
- 편리한 캡형 용기, 수분 증발 억제
- 알로에 베라 성분: 수분막, 보습막 형성, 민감한 피부 보호



알로에베라
Vitamin E & B5



행금 불필요



비자극성



부드러운
촉감



고강도



이중 마감 처리



저자극향



Item# MED0040002

Size 22.9cm x 33cm

64 pcs/pack 8 packs/carton





All Around the World



제품문의 및 상담

FREE SAMPLE **02 393 7105**



Think Mask ■ Think Pouch ■ Think Glove ■ Think MEDICOM



Proud Leaders
in Infection Control Since 1988



SafeSeal®

SafeWear®



SafeTouch®

SafeGauze®

SafeBasics™

SafeMask®



ABOUT MEDICOM



Mission Statement

The Medicom Group is a global healthcare company dedicated to enhancing, manufacturing, and distributing infection control, single-use and preventive products for medical, dental, industrial, veterinary and laboratory markets.

We strive to provide distributors, professionals and their patients, the most trusted branded and private label product at outstanding value.

We bring entrepreneurial passion to everything we do in order to create remarkable customer experiences.



f Medicom Korea



www.medicom.com

MEDICOM KOREA 메디컴 코리아
서울시 서대문구 충정로 53 골든타워빌딩 1711호

Tel: 02 393 7105

Fax: 02 393 8105

Email: sales@medicom-korea.com