

Waste systems

SafetyWasteCaps – One system for every thread

The fluids in the waste containers in the laboratory are overwhelmingly poisonous – the user often does not know which mixture can emerge in the canisters. Closed safety systems from S.C.A.T. Europe offer reassuring protection and also guarantee efficient work in the laboratory.

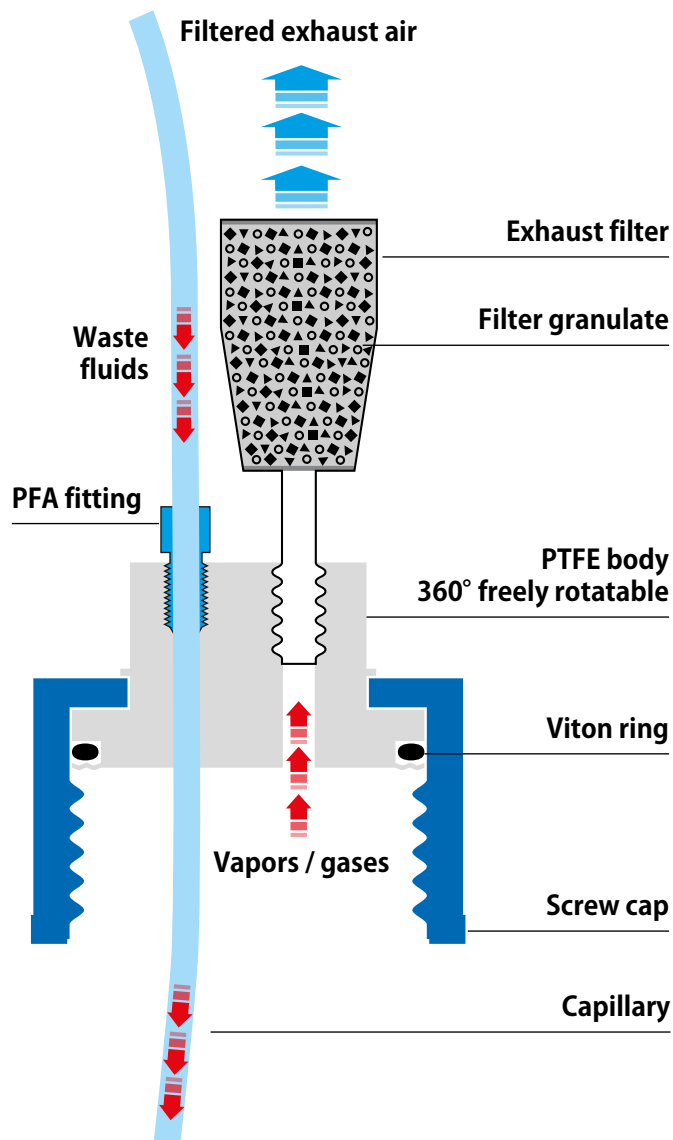

- » **Filter system against harmful vapors**
Exhaust filters in different sizes you will find on pages 59 - 60.
- » **Different thread sizes**
Use SafetyWasteCaps on your available containers, or order the appropriate canisters at the same time! Starting from Page 87.
- » **Resistant against aggressive media**
Because they are made of pure PTFE and PE-HD, SafetyWasteCaps are resistant against organic solvents, acids and lyes.

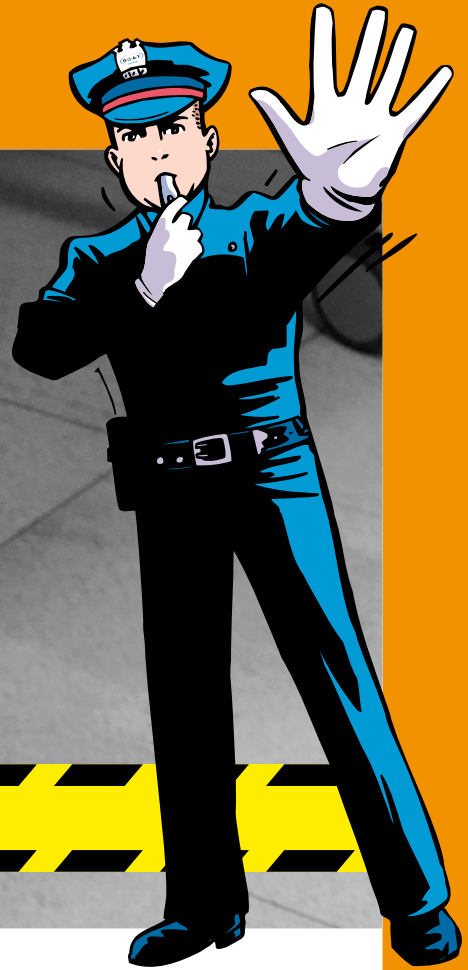

Incorrect disposal of laboratory waste is highly dangerous



Safe and clean disposal with S.C.A.T. SafetyWasteCaps



Waste systems

Central element of the waste system: Exhaust filter protects from harmful vapors

Exhaust filters keep your work-space safe clean. The exhaust filter is an essential component of the S.C.A.T. safety system. It cleans solvent vapors from the exhaust air.

With a specific surface of **1,200 m²/g**, our multicomponent granulate is the optimum filter media for nearly all solvent vapors. It is based on active charcoal and contains additional components which prevent sticking or clump formation and so prevents restriction of the filter performance. **99% of the volatile substances are captured here.**



Safety at the push of a button with the helpful change indicator

Exhaust filters are permanently exposed to vapours, dust particles and pollutants. Exchange saturated filters within their service life to maintain your workspace safety. With the useful **change indicator** the inspection is easier than ever before.

Install the exhaust filter as usual on your solvent reservoir. The filters fit to all S.C.A.T. waste systems. **By pushing the button the activation is done.**

The change indicator shows the elapsed service life clearly and is easy to observe.

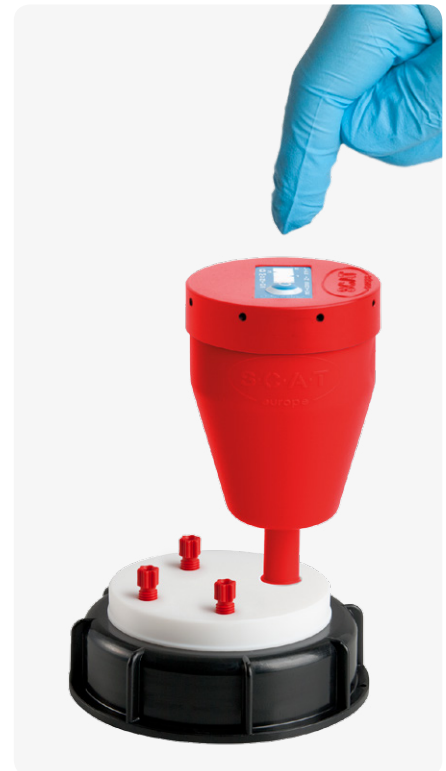

Turn in the filter and activate at the push of a button.

The change indicator signals if an exchange become due.

Due to different container sizes and space conditions on smaller SafetyWasteCaps we offer exhaust filters in various sizes. We also offer exhaust filter size L (volume optimized, recommended for waste containers with a volume of more than 20 liters) and XL-versions for barrels. All exhaust filters you will find on the pages 59 - 60.



Part No. 610 534
Exhaust filter "S"
3 Months



Part No. 610 535
Exhaust filter "M"
6 Months

Waste systems

The capillary connector



- » Capillaries \varnothing 2.3/3.2 mm OD (\varnothing 1.6 mm optional)
- » Several systems can be connected to one waste container
- » Capillary fixation with PFA fittings
- » More possible connections through the use of adapters

Direct connection of your HPLC with the disposal system. The SafetyWasteCaps are delivered ready for connection and fit capillaries with an outer diameter of 2.3 and 3.2 mm. (Fittings for capillaries with 1.6 mm outer diameter optionally available). For larger filling quantities there are variants with tube connector.

Our caps are suitable with any HPLC system. If you like to connect capillaries even less than provided on your SafetyWasteCap you can block remaining connections with blind plugs.

Accessories for the capillary connector you will find on page 105.

The tube connector



- » Standard fitting for tubes with \varnothing 6.4 - 9.0 mm ID
- » Flexible like no other: numerous tube fittings available
- » Up to 8 possible connections through the use of adapters

Larger waste tubes fit the tube connector. The standard connector design is for flexible tubes with an inner diameter of 6.4–9.0 mm.

We also have suitable connections for other tube diameters! On **page 107** you will find all of our tube fittings which you can turn into the tube connector and on **page 108** all suitable adapters. The images are shown in the scale of 1:1 so you can determine your required size easily.

Accessories for the tube connector you will find on page 107. Selection of adapters on page 108.

Safety funnel with automatic closure



- » Maximum charge 280 ml (if valve is closed)
- » Available for SafetyWasteCaps with all common thread sizes
- » Safely collect sample residues and solvents
- » Valve closes automatically after filling

The useful funnel for filling smaller amounts of solvent, e.g. for preparing samples or emptying vials. When the button is released, the automatic mechanism closes and the canister never stands open in the laboratory. Harmful vapors can not escape without passing the exhaust filter.

For larger amounts we recommend our funnels with ball valve or hinged lid. An overview of the several types you will find on **page 63**.

Our range of safety funnels for larger filling quantities you will find starting from page 63.

Safety funnel with shut-off



- » Filling quantity 500 ml (if shut-off is closed)
- » Available for SafetyWasteCaps with all common thread sizes
- » Safe closing through shut-off
- » Both hands free for filling

For filling closed receptacles without inconvenient unscrewing of the canister. For safe disposal of medium amounts of typical laboratory fluids.

The funnel is opened and closed by turning the shut-off - this leaves both of your hands free to handle bottles and beakers, and then re-close the container quickly and cleanly.

Our range of safety funnels for larger filling quantities you will find starting from page 63.

Waste systems

Level control (mechanical)



- » Optical warning signal protects from overflowing
- » Ideal for containers of opaque material
- » Never vacate the laboratory again due to hazardous vapors

Overflowing waste containers in a laboratories can be dangerous when work is done with critical substances and solvents. Dangerous fumes can spread fast. This is not only dangerous for individual health but under certain circumstances, can also lead to an explosion.

The red floater is immediately visible if the container has reached the critical fill level. Even if there are many canisters, with a single glance you have everything under control. No overflow or interruption due to drained containers.

Further informations about level control starting from page 73.

Level control (electronic)



- » SafetyWasteCaps with electronic level control transmit warning signals to external connected electronic signal boxes
- » Monitoring of filling levels over greater distances from up to 200 m

Keep an eye on fill levels even from greater distances: Thanks to electronic level warning, you are informed in time when a waste container has filled up. Thanks to the extension cable, the signal box can be set up spatially separated from the container at variable distances.

SafetyWasteCaps with electronic level control can be connected to electronic signal boxes with 1-5 input lines. These offer automation and control of external devices such as pumps or valves.

All electronic signal boxes can be found starting from page 77.

Ground connection



- » Additive protection from explosive mixtures of waste in waste containers
- » For use with containers made from electrostatic conductive PE-HD

The contents of the waste containers can be additionally secured with the grounding connector. The grounding tube of electrostatic conductive plastic hangs into the liquid and makes contact.

On the top of the cap the contact can be conducted with a grounding cable.

Further grounding cables with mounted clamps and connectors you will find on page 115.



Fire-resistant material



- » Self-extinguishing material in case of fire
- » Combustion chamber tests with best value
- » Optimal protection - Naturally the closures offer all the proven S.C.A.T. quality features to protect the user and the environment.

In case of fire, the worldwide unique flame protection material is an insulating layer acting to brake heat. The foaming mass prevents oxygen supply and therefore the spread of flames. Naturally the closures offer all the proven S.C.A.T. quality features to protect the user and the environment. All limit values were fallen well below: During tests in the combustion chamber, SafetyCaps attained the highest fire class V0 and were significantly below all UL-94 test criteria.

Fire-resistant SafetyWasteCaps on page 35.
Fire-resistant exhaust filters on page 59.

Waste systems

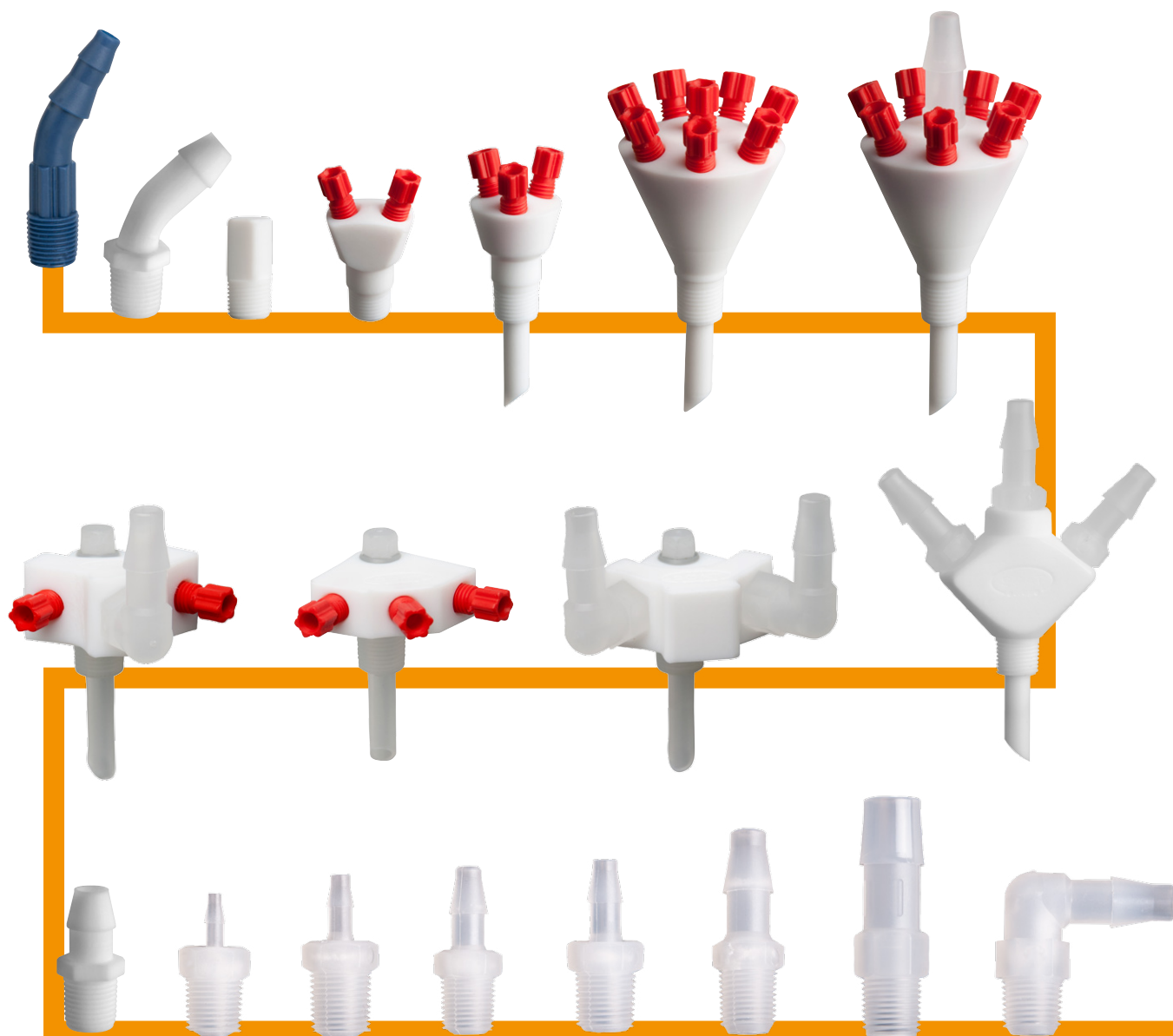

One system – endless possibilities!

A diversity which only S.C.A.T. Europe can provide. Through our years of experience and our commitment to provide solutions for the safe handling of hazardous waste liquids, we are familiar with all the connectors of laboratories in the world. Many of our products were developed from specific customer requirements and have become integral parts of our standard range.

A huge range of accessories starting from page 99.



Flexible like no other! The tube connector

The most special feature of our tube connector is its flexibility. The standard connector included in the scope of delivery can be exchanged with numerous adapters. This way, you can increase the number of connections or connect tubes with different diameters. You have many possibilities to connect several systems to one waste container.



All suitable adapters for the tube connector you will find on the pages 107 - 108 and on the useful fold out pages at the end of this chapter.



Tubes and capillaries you will find on page 117.

SafetyWasteCaps

Thread S 40 / GL 40

Thread GL 45

A 107 108

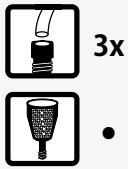

S 40 / GL 40

B 107 109



S 40 / GL 40

C 107 912

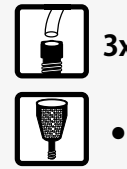

GL 45

D 107 923



GL 45

E 108 921



GL 45

F 112 921



GL 45

Helpful ordering tool

An overview, showing all possible connections to the tube connector at SafetyWasteCaps, you will find on the helpful fold out pages at the end of this chapter.

Offset adapter

Various offset adapters for exhaust filters you will find on page 104.



Thread information

GL 45 is the most frequent thread size for supply and waste containers in the laboratory. Many chemicals are delivered in GL 45 bottles.

ca. 44.5 mm = GL 45
ca. 40 mm = S 40 / GL 40

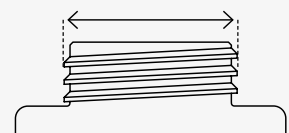

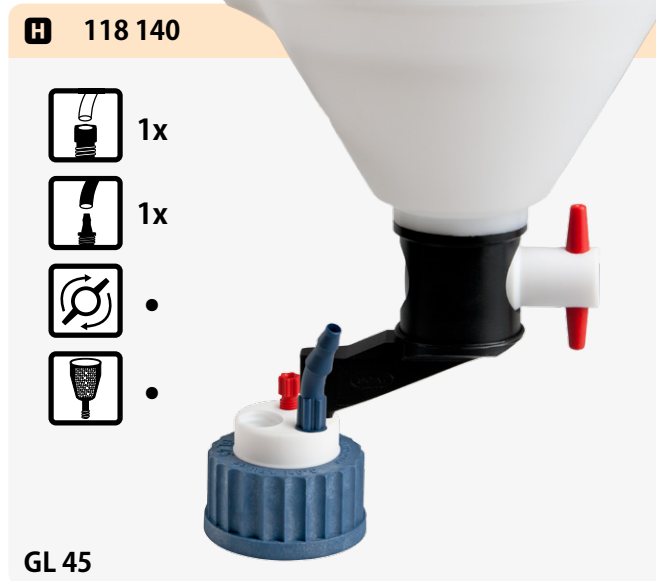
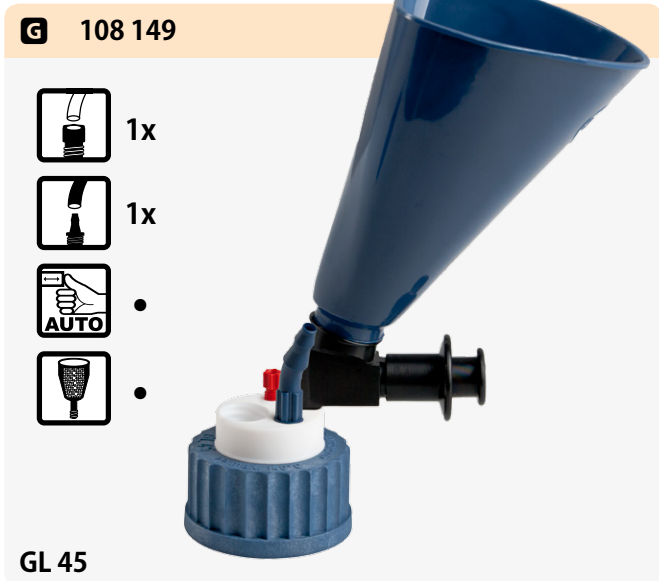

What kind of thread my canister has?

An overview, showing all helpful thread informations and measurements, you will find on the pages 87 - 88.

What is included in the scope of delivery?

The shown pictures accord to the scope of delivery. Fittings for capillaries with 2.3 / 3.2 mm outer diameter and if applicable, a tube fitting for tubes with 6.4 - 9.0 mm inner diameter are included.

Protect from harmful vapors!

Due to different container sizes and space conditions on smaller SafetyWasteCaps we offer exhaust filters in various sizes. Just choose your suitable size **S, M and L** for service lifes from **3 up to 6 months**. All exhaust filters you will find on the pages 59 - 60.

Fig.	Part No.	Thread	Capillary connector 2.3 / 3.2 mm OD	Tube connector 6.4 - 9.0 mm ID	Connector for exhaust filter	Safety funnel with automatic closure	Safety funnel with shut-off	Ground connection	Fire-resistant
A	107 108	S 40 / GL 40	3x	-	•	-	-	-	-
B	107 109	S 40 / GL 40	2x	1x	•	-	-	-	-
C	107 912	GL45	3x	-	•	-	-	-	-
-	112 912	GL45	3x	-	•	-	-	-	•
D	107 923	GL45	2x	1x	•	-	-	-	-
-	112 923	GL45	2x	1x	•	-	-	-	•
E	108 921	GL45	4x	1x	•	-	-	-	-
F	112 921	GL45	4x	1x	•	-	-	-	•
G	108 149	GL45	1x	1x	•	•	-	-	-
H	118 140	GL45	1x	1x	•	-	•	-	-

SafetyWasteCaps Thread S 50 (space-saving canister)



Helpful ordering tool

An overview, showing all possible connections to the tube connector at SafetyWasteCaps, you will find on the helpful fold out pages at the end of this chapter.

Offset adapter

Various offset adapters for exhaust filters you will find on page 104.

Base

The useful base for 2 space saving canisters and further informations you will find on page 91 - 92.



Thread information

Appropriate thread for our space-saving canisters.

ca. 50 mm

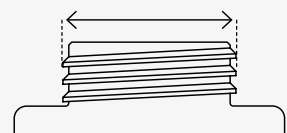



What kind of thread my canister has?

An overview, showing all helpful thread informations and measurements, you will find on the pages 87 - 88.

What is included in the scope of delivery?

The shown pictures accord to the scope of delivery. Fittings for capillaries with 2.3 / 3.2 mm outer diameter and if applicable, a tube fitting for tubes with 6.4 - 9.0 mm inner diameter are included.

Protect from harmful vapors!

Due to different container sizes and space conditions on smaller SafetyWasteCaps we offer exhaust filters in various sizes. Just choose your suitable size **S, M and L** for service lifes from 3 up to 6 months. All exhaust filters you will find on the pages 59 - 60.

Fig.	Part No.	Capillary connector 2.3 / 3.2 mm OD	Tube connector 6.4 - 9.0 mm ID	Connector for exhaust filter	Level control (mechanical)	Level control (electronic)	Safety funnel with automatic closure	Safety funnel with shut-off	Ground connection
A	108 023	3x	-	•	-	-	-	-	-
B	108 024	3x	-	•	-	-	-	-	•
C	108 025	2x	1x	•	-	-	-	-	-
D	108 026	2x	1x	•	-	-	-	-	•
E	108 132	2x	-	•	-	-	•	-	-
F	118 141	2x	-	•	-	-	-	•	-

SafetyWasteCaps Thread S 51

A 107 930

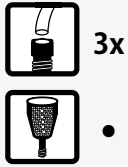

3x

•



B 107 922



2x

1x

•



C 107 942

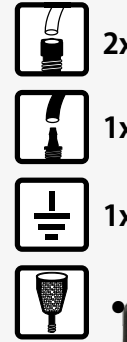

2x

1x

1x

•



Protect from harmful vapors!

Due to different container sizes and space conditions on smaller Safety-WasteCaps we offer exhaust filters in various sizes. Just choose your suitable size **S, M and L** for service lives from 3 up to 6 months. All exhaust filters you will find on the pages 59 - 60.

Thread information

Nearly identical to S 50. Only the outer diameter (OD) of the container thread is significantly different.

ca. 48 mm

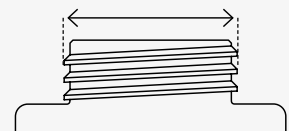

Offset adapter

Various offset adapters for exhaust filters you will find on page 104.





Helpful ordering tool

An overview, showing all possible connections to the tube connector at SafetyWasteCaps, you will find on the helpful fold out pages at the end of this chapter.

What kind of thread my canister has?

An overview, showing all helpful thread informations and measurements, you will find on the pages 87 - 88.

What is included in the scope of delivery?

The shown pictures accord to the scope of delivery. Fittings for capillaries with 2.3 / 3.2 mm outer diameter and if applicable, a tube fitting for tubes with 6.4 - 9.0 mm inner diameter are included.

Fig.	Part No.	Capillary connector 2.3 / 3.2 mm OD	Tube connector 6.4 - 9.0 mm ID	Connector for exhaust filter	Level control (mechanical)	Level control (electronic)	Safety funnel with automatic closure	Safety funnel with shut-off	Ground connection
A	107 930	3x	-	●	-	-	-	-	-
-	107 935	3x	-	●	-	-	-	-	●
B	107 922	2x	1x	●	-	-	-	-	-
C	107 942	2x	1x	●	-	-	-	-	●
-	107 241	2x	-	●	●	-	-	-	-
D	107 242	2x	-	●	-	●	-	-	-
E	107 243	1x	1x	●	-	-	●	-	-
F	107 244	1x	1x	●	-	-	-	●	-



SafetyWasteCaps Thread B 53

Helpful ordering tool

An overview, showing all possible connections to the tube connector at SafetyWasteCaps, you will find on the helpful fold out pages at the end of this chapter.







A 107 037

-  4x
-  1x
-  •





B 107 054

-  3x
-  1x
-  1x
-  •



C 107 245

-  1x
-  1x
-  •
-  •



D 107 246

-  1x
-  1x
-  •
-  •



Thread information

For containers of the brand NALGENE®.

ca. 53 mm

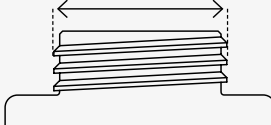

What kind of thread my canister has?

An overview, showing all helpful thread informations and measurements, you will find on the pages 87 - 88.



What is included in the scope of delivery?

The shown pictures accord to the scope of delivery. Fittings for capillaries with 2.3 / 3.2 mm outer diameter and if applicable, a tube fitting for tubes with 6.4 - 9.0 mm inner diameter are included.

Protect from harmful vapors!

Due to different container sizes and space conditions on smaller SafetyWasteCaps we offer exhaust filters in various sizes. Just choose your suitable size **S, M and L** for service lifes from **3 up to 6 months**. All exhaust filters you will find on the pages 59 - 60.

Fig.	Part No.	Capillary connector 2.3 / 3.2 mm OD	Tube connector 6.4 - 9.0 mm ID	Connector for exhaust filter	Level control (mechanical)	Level control (electronic)	Safety funnel with automatic closure	Safety funnel with shut-off	Ground connection
A	107 037	4x	1x	•	-	-	-	-	-
B	107 054	3x	1x	•	-	-	-	-	•
C	107 245	1x	1x	•	•	-	-	-	-
D	107 246	1x	1x	•	-	•	-	-	-
E	107 057	1x	1x	•	-	-	•	-	-
F	118 142	1x	1x	•	-	-	-	•	-

SafetyWasteCaps Thread S 55



Helpful ordering tool

An overview, showing all possible connections to the tube connector at SafetyWasteCaps, you will find on the helpful fold out pages at the end of this chapter.

Thread information

The number "51" is often in the cover.

ca. 53.5 mm

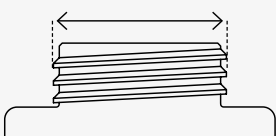

What kind of thread my canister has?

An overview, showing all helpful thread informations and measurements, you will find on the pages 87 - 88.





What is included in the scope of delivery?

The shown pictures accord to the scope of delivery. Fittings for capillaries with 2.3 / 3.2 mm outer diameter and if applicable, a tube fitting for tubes with 6.4 - 9.0 mm inner diameter are included.

Protect from harmful vapors!



Due to different container sizes and space conditions on smaller SafetyWasteCaps we offer exhaust filters in various sizes. Just choose your suitable size **S, M and L** for service lifes from 3 up to 6 months. All exhaust filters you will find on the pages 59 - 60.

Fig.	Part No.	Capillary connector 2.3 / 3.2 mm OD	Tube connector 6.4 - 9.0 mm ID	Connector for exhaust filter	Level control (mechanical)	Level control (electronic)	Safety funnel with automatic closure	Safety funnel with shut-off	Ground connection
A	107 917	3x	-	•	-	-	-	-	-
B	107 924	2x	1x	•	-	-	-	-	-
C	107 936	3x	-	•	-	-	-	-	•
-	107 943	2x	1x	•	-	-	-	-	•
D	107 960	3x	-	•	•	-	-	-	-
-	107 963	2x	1x	•	•	-	-	-	-
-	108 030	3x	-	•	•	-	-	-	•
E	108 200	3x	-	•	-	•	-	-	-
-	108 201	2x	1x	•	-	•	-	-	-
F	108 033	2x	-	•	-	-	•	-	-
-	108 128	-	-	•	-	-	•	-	-
G	118 143	2x	-	•	-	-	-	•	-
-	118 149	-	-	•	-	-	-	•	-

SafetyWasteCaps Thread S 60/61

WASTE SYSTEMS

A 107 918

-  3x
-  •



B 107 925

-  2x
-  1x
-  •



C 107 916

-  3x
-  •
-  •



D 107 964

-  2x
-  1x
-  •
-  •



E 108 403

-  2x
-  1x
-  •
-  •



F 108 034

-  2x
-  •
-  •



Thread information

The number "61" is often in the cover.

ca. 59 mm

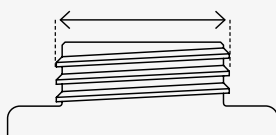

Helpful ordering tool

An overview, showing all possible connections to the tube connector at SafetyWasteCaps, you will find on the helpful fold out pages at the end of this chapter.

Protect from harmful vapors! All exhaust filters you will find on the pages 59 - 60.







What is included in the scope of delivery?

The shown pictures accord to the scope of delivery. Fittings for capillaries with 2.3 / 3.2 mm outer diameter and if applicable, a tube fitting for tubes with 6.4 - 9.0 mm inner diameter are included.

Fig.	Part No.	Capillary connector 2.3 / 3.2 mm OD	Tube connector 6.4 - 9.0 mm ID	Connector for exhaust filter	Level control (mechanical)	Level control (electronic)	Safety funnel with automatic closure	Safety funnel with shut-off	Ground connection
A	107 918	3x	-	●	-	-	-	-	-
B	107 925	2x	1x	●	-	-	-	-	-
C	107 916	3x	-	●	-	-	-	-	●
-	107 944	2x	1x	●	-	-	-	-	●
D	107 964	2x	1x	●	●	-	-	-	-
-	108 964	2x	1x	●	●	-	-	-	●
-	107 961	3x	-	●	●	-	-	-	-
-	108 961	3x	-	●	●	-	-	-	●
E	108 403	2x	1x	●	-	●	-	-	-
-	108 404	2x	1x	●	-	●	-	-	●
-	108 401	3x	-	●	-	●	-	-	-
-	108 402	3x	-	●	-	●	-	-	●
F	108 034	2x	-	●	-	-	●	-	-
-	108 134	2x	-	●	●	-	●	-	-
-	108 138	2x	1x	●	●	-	●	-	-
-	118 034	2x	-	●	-	●	●	-	-
G	118 038	2x	1x	●	-	●	●	-	-
-	108 129	-	-	●	-	-	●	-	-
H	118 144	2x	-	●	-	-	-	●	-
-	118 244	2x	-	●	●	-	-	●	-
-	118 242	2x	1x	●	●	-	-	●	-
-	118 150	-	-	●	-	-	-	●	-

SafetyWasteCaps Thread B 63

A 107 051

-  3x
-  •



B 107 050

-  2x
-  1x
-  •



C 107 038

-  1x
-  3x
-  •



D 107 247

-  2x
-  1x
-  •
-  •



E 107 248

-  2x
-  1x
-  •
-  •



F 107 249

-  2x
-  1x
-  •
-  •



Helpful ordering tool

An overview, showing all possible connections to the tube connector at SafetyWasteCaps, you will find on the helpful fold out pages at the end of this chapter.

Thread information

For containers of the brand NALGENE®.

ca. 62 mm

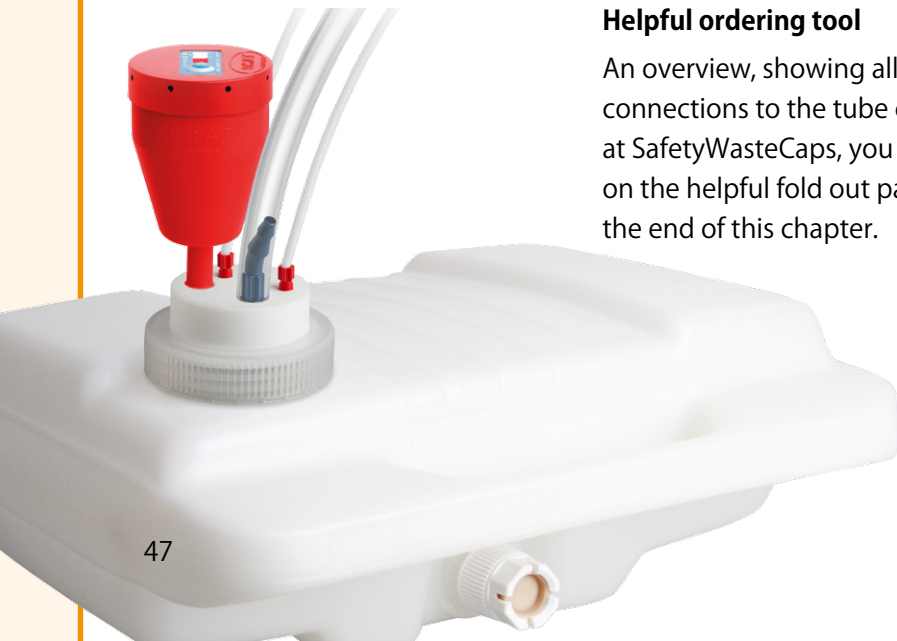
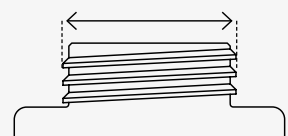

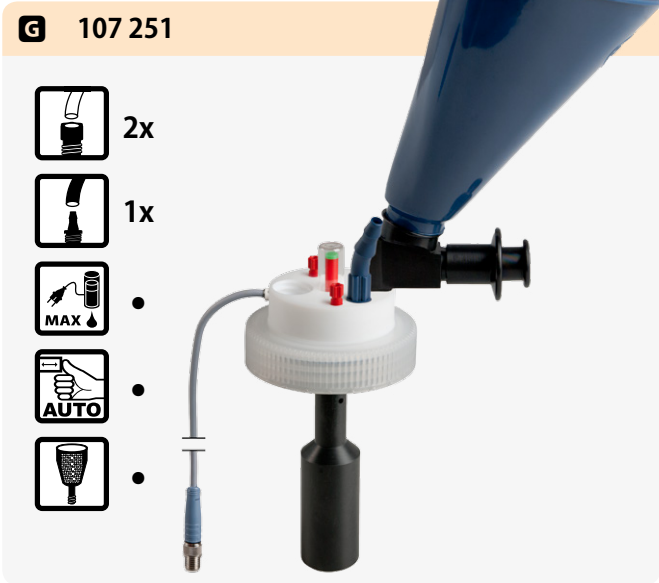

What is included in the scope of delivery?

The shown pictures accord to the scope of delivery. Fittings for capillaries with 2.3 / 3.2 mm outer diameter and if applicable, a tube fitting for tubes with 6.4 - 9.0 mm inner diameter are included.

What kind of thread my canister has?

An overview, showing all helpful thread informations and measurements, you will find on the pages 87 - 88.



Protect from harmful vapors!

Due to different container sizes and space conditions on smaller SafetyWasteCaps we offer exhaust filters in various sizes. Just choose your suitable size **S, M and L** for service lifes from 3 up to 6 months. All exhaust filters you will find on the pages 59 - 60.

Fig.	Part No.	Capillary connector 2.3 / 3.2 mm OD	Tube connector 6.4 - 9.0 mm ID	Connector for exhaust filter	Level control (mechanical)	Level control (electronic)	Safety funnel with automatic closure	Safety funnel with shut-off	Ground connection
A	107 051	3x	-	●	-	-	-	-	-
B	107 050	2x	1x	●	-	-	-	-	-
C	107 038	1x	3x	●	-	-	-	-	-
D	107 247	2x	1x	●	●	-	-	-	-
E	107 248	2x	1x	●	-	●	-	-	-
F	107 249	2x	1x	●	-	-	●	-	-
-	107 250	2x	1x	●	●	-	●	-	-
G	107 251	2x	1x	●	-	●	●	-	-
H	107 252	2x	1x	●	-	-	-	●	-
-	107 253	2x	1x	●	●	-	-	●	-
-	107 254	2x	1x	●	-	●	-	●	-

SafetyWasteCaps Thread S 65

A 108 046

-  5x
-  •



B 108 047

-  4x
-  1x
-  •

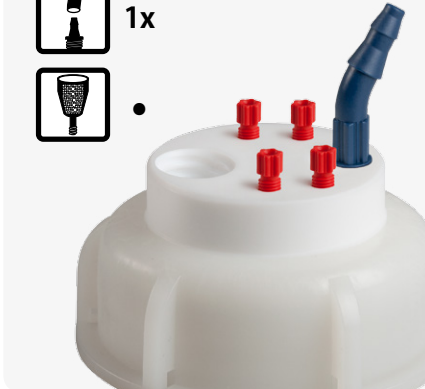

C 108 054

-  5x
-  •
-  •





D 107 969

-  4x
-  1x
-  •
-  •



E 108 203

-  2x
-  1x
-  •
-  •



F 108 150

-  4x
-  •
-  •



Helpful ordering tool

An overview, showing all possible connections to the tube connector at SafetyWasteCaps, you will find on the helpful fold out pages at the end of this chapter.

What kind of thread my canister has?

An overview, showing all helpful thread informations and measurements, you will find on the pages 87 - 88.

Thread information

For containers of the brand KAUTEX®.

ca. 64.5 mm

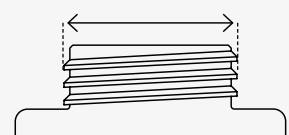

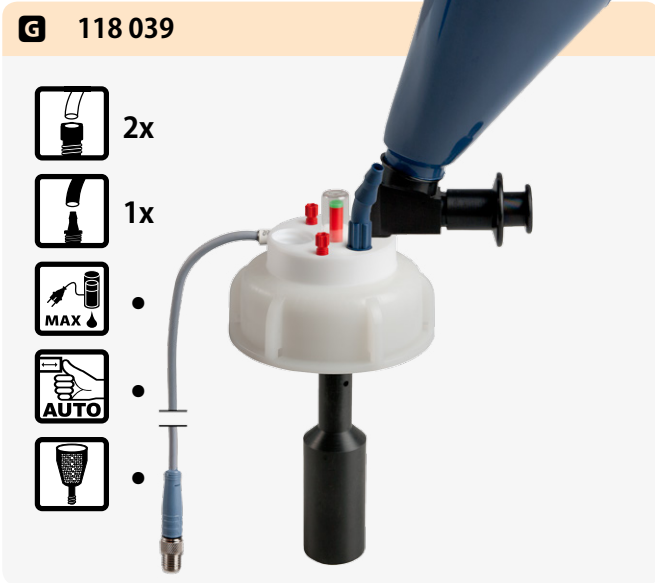

What is included in the scope of delivery?

The shown pictures accord to the scope of delivery. Fittings for capillaries with 2.3 / 3.2 mm outer diameter and if applicable, a tube fitting for tubes with 6.4 - 9.0 mm inner diameter are included.



Protect from harmful vapors!

Due to different container sizes and space conditions on smaller SafetyWasteCaps we offer exhaust filters in various sizes. Just choose your suitable size **S, M and L** for service lives from 3 up to 6 months. All exhaust filters you will find on the pages 59 - 60.

Fig.	Part No.	Capillary connector 2.3 / 3.2 mm OD	Tube connector 6.4 - 9.0 mm ID	Connector for exhaust filter	Level control (mechanical)	Level control (electronic)	Safety funnel with automatic closure	Safety funnel with shut-off	Ground connection
A	108 046	5x	-	●	-	-	-	-	-
B	108 047	4x	1x	●	-	-	-	-	-
C	108 054	5x	-	●	-	-	-	-	●
-	108 055	4x	1x	●	-	-	-	-	●
-	107 968	4x	-	●	●	-	-	-	-
D	107 969	4x	1x	●	●	-	-	-	-
-	108 202	3x	-	●	-	●	-	-	-
E	108 203	2x	1x	●	-	●	-	-	-
F	108 150	4x	-	●	-	-	●	-	-
-	108 133	3x	1x	●	●	-	●	-	-
-	108 135	4x	-	●	●	-	●	-	-
-	118 035	4x	-	●	-	●	●	-	-
G	118 039	3x	1x	●	-	●	●	-	-
H	118 145	4x	-	●	-	-	-	●	-
-	118 245	4x	-	●	●	-	-	●	-
-	118 246	3x	1x	●	●	-	-	●	-

SafetyWasteCaps Thread S 70/71

A 107 913

-  3x
-  •



B 107 926

-  2x
-  1x
-  •

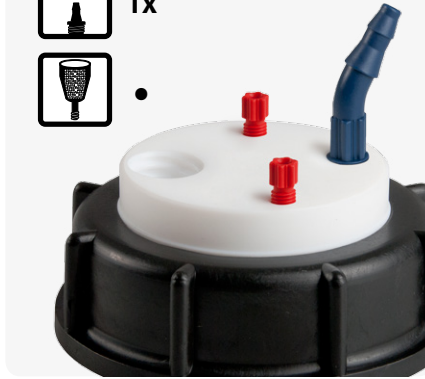

C 107 915

-  5x
-  •
-  •



D 107 965

-  2x
-  1x
-  •
-  •



E 108 407

-  2x
-  1x
-  •
-  •



F 108 035

-  4x
-  •
-  •



Helpful ordering tool

An overview, showing all possible connections to the tube connector at SafetyWasteCaps, you will find on the helpful fold out pages at the end of this chapter.

Gewindeinfo

The number "71" is often in the cover.

ca. 70 mm

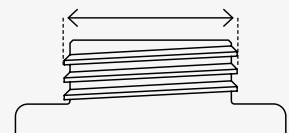

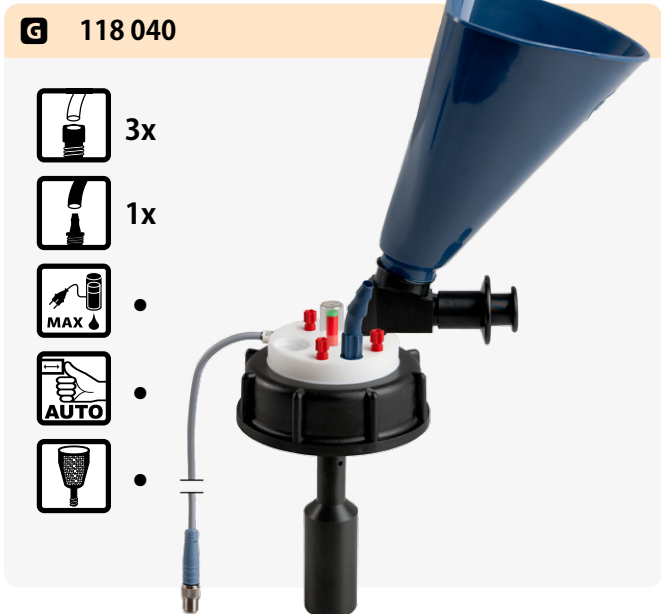

What is included in the scope of delivery?

The shown pictures accord to the scope of delivery. Fittings for capillaries with 2.3 / 3.2 mm outer diameter and if applicable, a tube fitting for tubes with 6.4 - 9.0 mm inner diameter are included.

Protect from harmful vapors! All exhaust filters you will find on the pages 59 - 60.

Fig.	Part No.	Capillary connector 2.3 / 3.2 mm OD	Tube connector 6.4 - 9.0 mm ID	Connector for exhaust filter	Level control (mechanical)	Level control (electronic)	Safety funnel with automatic closure	Safety funnel with shut-off	Ground connection
A	107 913	3x	-	•	-	-	-	-	-
B	107 926	2x	1x	•	-	-	-	-	-
C	107 915	3x	-	•	-	-	-	-	•
-	107 945	2x	1x	•	-	-	-	-	•
-	107 962	3x	-	•	•	-	-	-	-
D	107 965	2x	1x	•	•	-	-	-	-
-	108 405	3x	-	•	-	•	-	-	-
-	108 406	3x	-	•	-	•	-	-	•
E	108 407	2x	1x	•	-	•	-	-	-
-	108 408	2x	1x	•	-	•	-	-	•
F	108 035	4x	-	•	-	-	•	-	-
-	108 136	4x	-	•	•	-	•	-	-
-	108 139	3x	1x	•	•	-	•	-	-
-	118 036	4x	-	•	-	•	•	-	-
G	118 040	4x	1x	•	-	•	•	-	-
H	118 146	4x	-	•	-	-	-	•	-
-	118 247	4x	-	•	•	-	-	•	-
-	118 248	4x	1x	•	•	-	-	•	-

SafetyWasteCaps Thread B 83

WASTE SYSTEMS

A 107 036

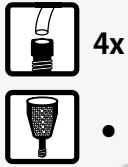

B 107 052



C 107 034



D 108 156



E 108 205



F 108 151



Thread information

For containers of the brand NALGENE®

ca. 88 mm

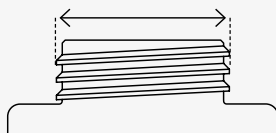

Helpful ordering tool

An overview, showing all possible connections to the tube connector at SafetyWasteCaps, you will find on the helpful fold out pages at the end of this chapter.

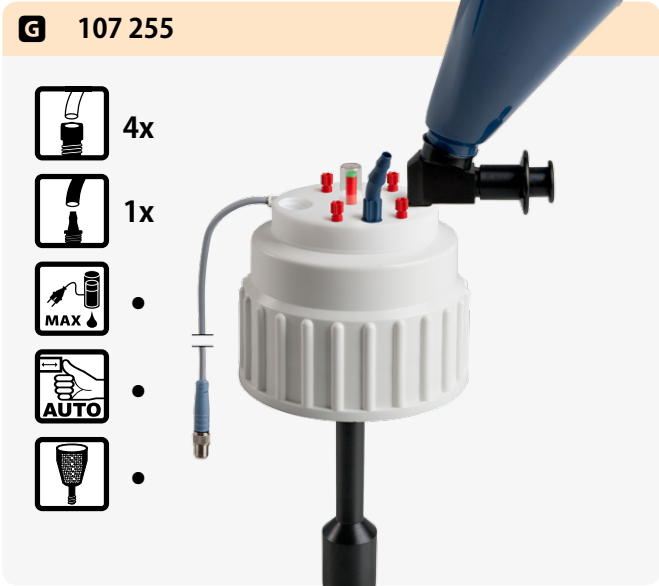

What kind of thread my canister has?

An overview, showing all helpful thread informations and measurements, you will find on the pages 87 - 88.

What is included in the scope of delivery?

The shown pictures accord to the scope of delivery. Fittings for capillaries with 2.3 / 3.2 mm outer diameter and if applicable, a tube fitting for tubes with 6.4 - 9.0 mm inner diameter are included.

Protect from harmful vapors!

Due to different container sizes and space conditions on smaller SafetyWasteCaps we offer exhaust filters in various sizes. Just choose your suitable size **S, M and L** for service lives from 3 up to 6 months. All exhaust filters you will find on the pages 59 - 60.

Fig.	Part No.	Capillary connector 2.3 / 3.2 mm OD	Tube connector 6.4 - 9.0 mm ID	Connector for exhaust filter	Level control (mechanical)	Level control (electronic)	Safety funnel with automatic closure	Safety funnel with shut-off	Ground connection
A	107 036	4x	-	●	-	-	-	-	-
B	107 052	4x	-	●	-	-	-	-	●
C	107 034	4x	1x	●	-	-	-	-	-
-	107 053	4x	1x	●	-	-	-	-	●
-	108 155	4x	-	●	●	-	-	-	-
D	108 156	4x	1x	●	●	-	-	-	-
E	108 205	4x	1x	●	-	●	-	-	-
-	108 204	4x	-	●	-	●	-	-	-
F	108 151	4x	-	●	-	-	●	-	-
G	107 255	4x	1x	●	-	●	●	-	-
H	118 147	4x	-	●	-	-	-	●	-

SafetyWasteCaps Thread S 90

A 107 927

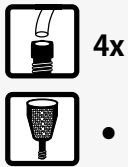

B 107 928



C 107 947



D 107 967



E 108 231

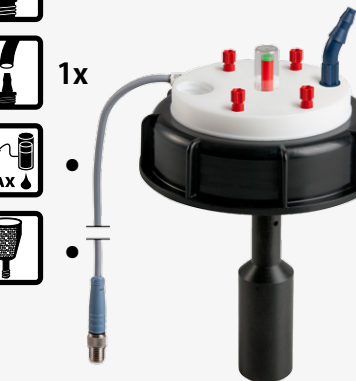
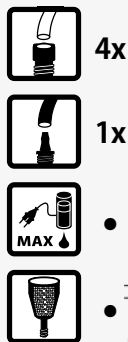

F 108 152



Helpful ordering tool

An overview, showing all possible connections to the tube connector at SafetyWasteCaps, you will find on the helpful fold out pages at the end of this chapter.

Thread information

The number "D90" is often in the cover.

ca. 88 mm

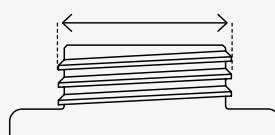

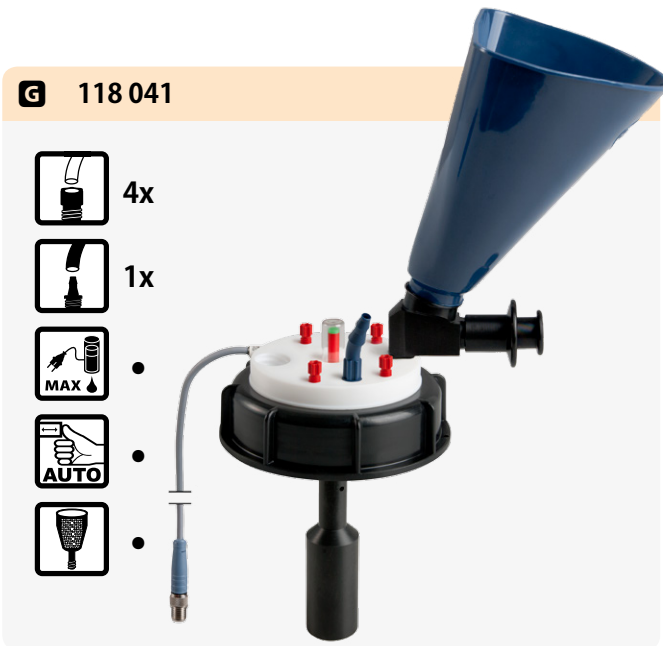

What is included in the scope of delivery?

The shown pictures accord to the scope of delivery. Fittings for capillaries with 2.3 / 3.2 mm outer diameter and if applicable, a tube fitting for tubes with 6.4 - 9.0 mm inner diameter are included.

Protect from harmful vapors! All exhaust filters you will find on the pages 59 - 60.

Fig.	Part No.	Capillary connector 2.3 / 3.2 mm OD	Tube connector 6.4 - 9.0 mm ID	Connector for exhaust filter	Level control (mechanical)	Level control (electronic)	Safety funnel with automatic closure	Safety funnel with shut-off	Ground connection
A	107 927	4x	-	●	-	-	-	-	-
B	107 928	4x	-	●	-	-	-	-	●
C	107 947	4x	1x	●	-	-	-	-	-
-	107 949	4x	1x	●	-	-	-	-	●
-	107 966	4x	-	●	●	-	-	-	-
D	107 967	4x	1x	●	●	-	-	-	-
-	108 031	4x	-	●	●	-	-	-	●
-	108 230	4x	-	●	-	●	-	-	-
E	108 231	4x	1x	●	-	●	-	-	-
F	108 152	4x	-	●	-	-	●	-	-
-	108 137	4x	-	●	●	-	●	-	-
-	108 140	4x	1x	●	●	-	●	-	-
-	118 037	4x	-	●	-	●	●	-	-
G	118 041	4x	1x	●	-	●	●	-	-
H	118 148	4x	-	●	-	-	-	●	-
-	118 249	4x	-	●	●	-	-	●	-
-	118 250	4x	1x	●	●	-	-	●	-

SafetyWasteCaps Thread S 95

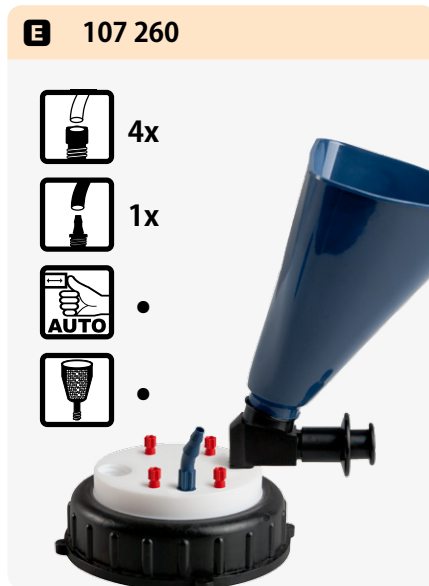
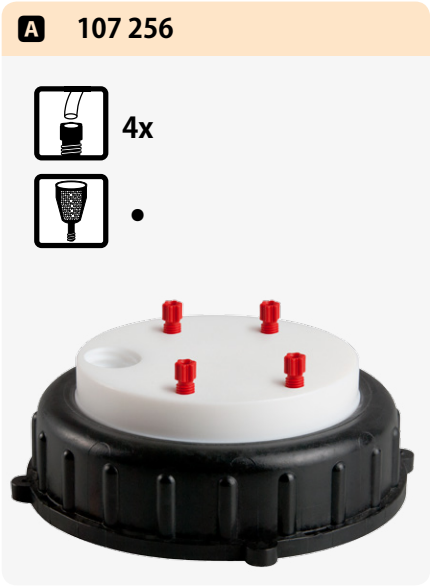

Thread information

Largest thread from our standard assortment. For additional sizes, we also offer customized products according to customer specifications.

ca. 94 mm

Helpful ordering tool

An overview, showing all possible connections to the tube connector at SafetyWasteCaps, you will find on the helpful fold out pages at the end of this chapter.



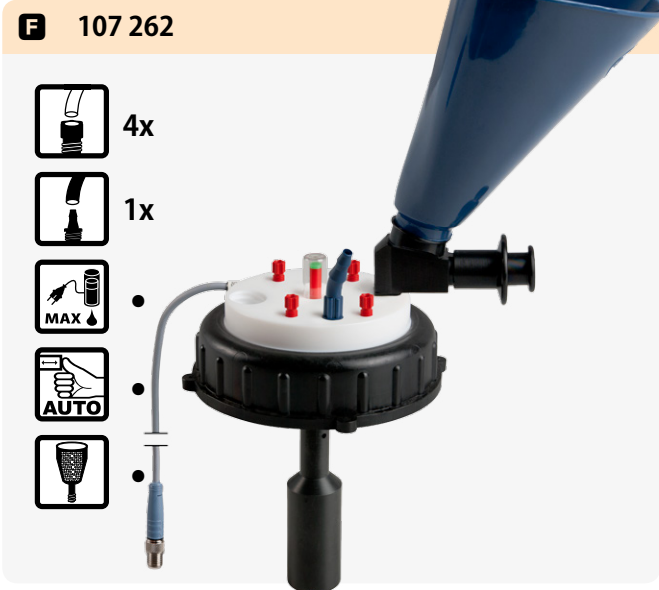

What kind of thread my canister has?

An overview, showing all helpful thread informations and measurements, you will find on the pages 87 - 88.

What is included in the scope of delivery?

The shown pictures accord to the scope of delivery. Fittings for capillaries with 2.3 / 3.2 mm outer diameter and if applicable, a tube fitting for tubes with 6.4 - 9.0 mm inner diameter are included.

Protect from harmful vapors!

Due to different container sizes and space conditions on smaller SafetyWasteCaps we offer exhaust filters in various sizes. Just choose your suitable size **S, M and L** for service lifes from 3 up to 6 months. All exhaust filters you will find on the pages 59 - 60.

Fig.	Part No.	Capillary connector 2.3 / 3.2 mm OD	Tube connector 6.4 - 9.0 mm ID	Connector for exhaust filter	Level control (mechanical)	Level control (electronic)	Safety funnel with automatic closure	Safety funnel with shut-off	Ground connection
A	107 256	4x	-	•	-	-	-	-	-
B	107 257	4x	1x	•	-	-	-	-	-
C	107 258	4x	1x	•	•	-	-	-	-
D	107 259	4x	1x	•	-	•	-	-	-
E	107 260	4x	1x	•	-	-	•	-	-
-	107 261	4x	1x	•	•	-	•	-	-
F	107 262	4x	1x	•	-	•	•	-	-
G	107 263	4x	1x	•	-	-	-	•	-
-	107 264	4x	1x	•	•	-	-	•	-
-	107 265	4x	1x	•	-	•	-	•	-

SafetyWasteCaps Exhaust filters



The exhaust filter - central element of the S.C.A.T. waste system

All informations and explanations regarding the exhaust filter are shown on pages 27 - 28.

Offset adapter

Space problems on your SafetyWasteCap? No problem, offset adapters for the connection of exhaust filters you will find on page 104.



Fig.	Part No.	Filter size	Recommended for waste containers with a volume of...	Features	Service life
A	610 534	S (small)	up to 5 liters	Splash protection with change indicator	3 Months
B	112 911	S (small)	up to 5 liters	Fire-resistant	3 Months
C	610 535	M (medium)	up to 20 liters	Splash protection with change indicator	6 Months
D	112 914	M (medium)	up to 20 liters	Fire-resistant	6 Months
E	107 986	L (large)	more than 20 liters	Splash protection with change indicator	6 Months

Safety on stock!

The economy packages guarantee not only price advantages; you are always well-prepared for the upcoming filter change.

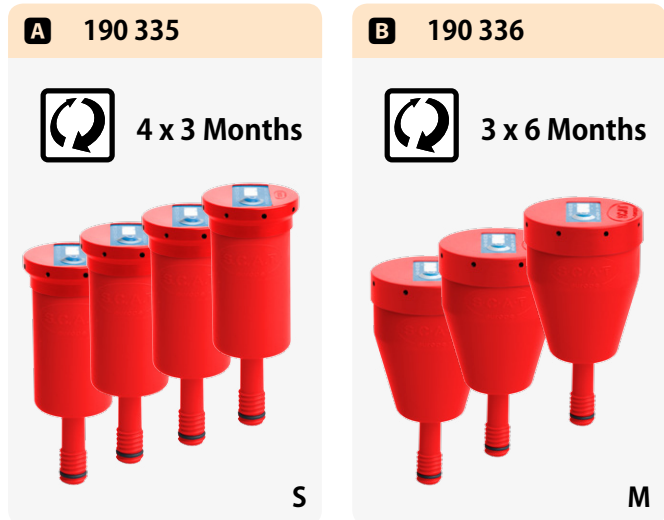

Fig.	Part No.	Description	Filter sizes	Number/unit
A	190 335	Economy package, exhaust filters with change indicator	S (small)	4 each
B	190 336	Economy package, exhaust filters with change indicator	M (medium)	3 each



Exhaust filters for barrels

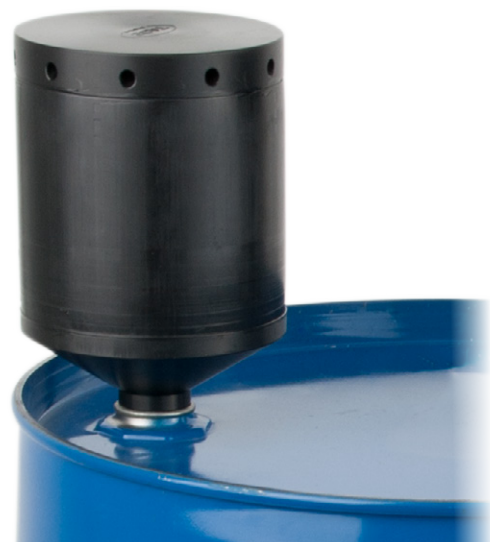
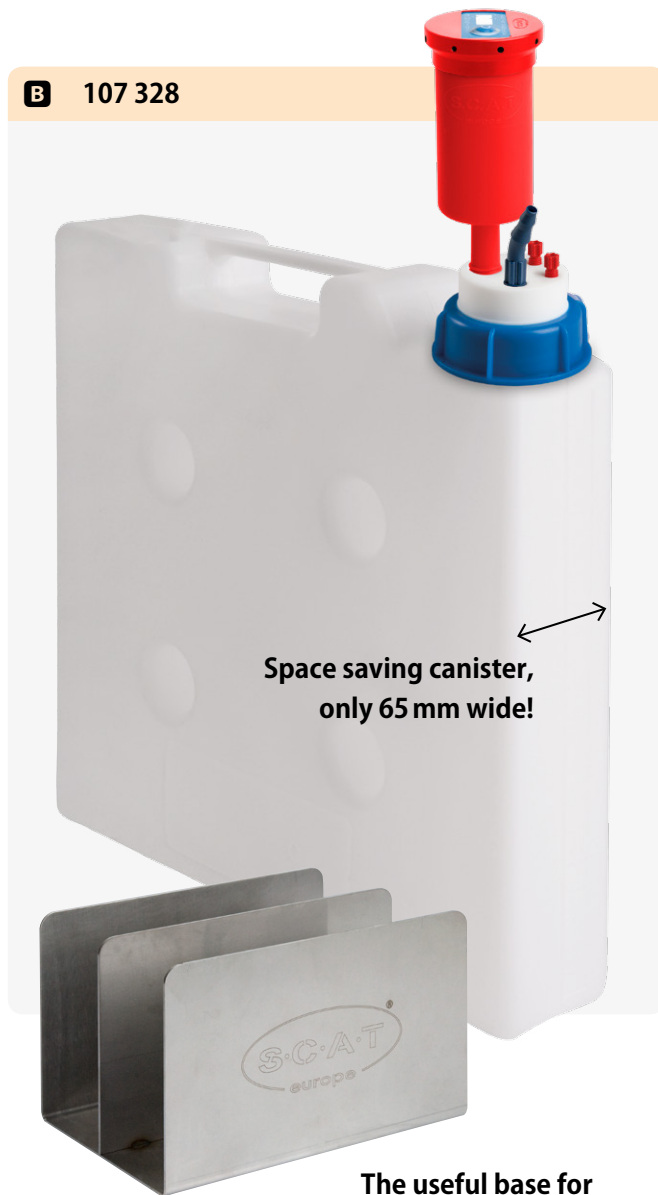

Fig.	Part No.	Filter size	Fill amount	Thread size	Recommended for barrel size	Service life	Unit
C	108 985	XL	520 g	G 3/4"	60 - 100 liters	9 Months	1
D	108 986	XXL	990 g	2" Mauer (BCS 70x6)	from 100 liters	12 Months	1
-	108 987	XXL	990 g	Double thread R 2" BSP/ G2" + 2" Tri-Sure	from 100 liters	12 Months	1

SafetyWasteCaps Complete sets



A 107 307





B 107 328

Space saving canister,
only 65 mm wide!

The useful base for
2 space saving canisters
you will find on page 92.

- » Only one article number for the comprehensive safety system
- » No time consuming compilation of a configuration
- » Price advantage compared to ordering piece by piece

Fig.	Part No. SET	 Capillary connector 2.3 / 3.2 mm OD	 Tube connector 6.4 - 9 mm ID	Scope of delivery	Dimensions W x H x D (mm)
A	107 307	2x	1x	107 951 Canister 5 liter, PP, thread GL 45 107 923 SafetyWasteCap, thread GL 45 610 534 Exhaust filter, size S	150 x 365 x 195
-	107 310	2x	1x	107 952 Canister 10 liter, PP, thread GL 45 107 923 SafetyWasteCap, thread GL 45 610 534 Exhaust filter, size S	190 x 415 x 230
B	107 328	2x	1x	107 998 Space saving canister, 5 liter, PP, thread S 50 108 025 SafetyWasteCap, thread S 50 610 534 Exhaust filter, size S	65 x 455 x 330



Flexible like no other! The tube connector

The most special feature of our tube connector is its flexibility. The standard connector included in the scope of delivery can be exchanged with numerous adapters. This way, you can increase the number of connections or connect tubes with different diameters. You have many possibilities to connect several systems to one waste container.

Useful overview,
please fold out the pages.

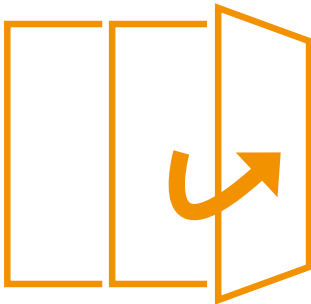



Flexible like no other! The tube connector

The most special feature of our tube connector is its flexibility. The standard connector included in the scope of delivery can be exchanged with numerous adapters. This way, you can increase the number of connections or connect tubes with different diameters. You have many possibilities to connect several systems to one waste container.

Useful overview,
please fold out the pages.

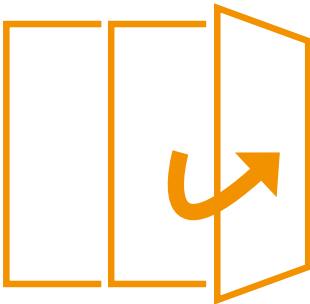

Accessories Accessories for the tube connector



Useful overview,
please fold out the pages.

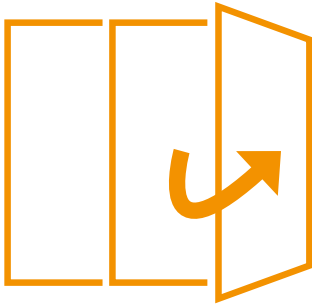



Accessories

Tube fittings for the tube connector

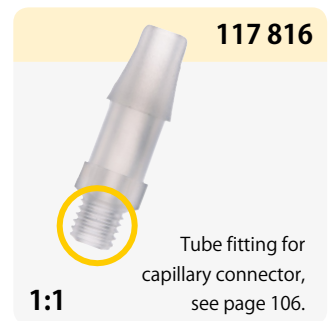
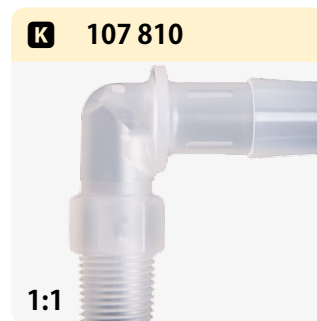
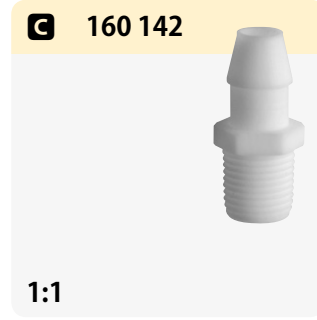
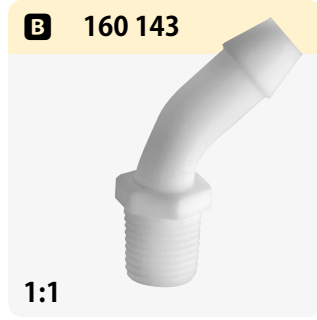

Images A - K shown on a scale of 1:1

Just add the tube and identify the size easily.



Fig.	Part No.	Description	For tube diameter	Material	Unit
A	117 808	Stepped fitting, curved	6.4 - 9 mm ID	PP	1
B	160 143	Tube fitting, curved	6.4 - 8 mm ID	PTFE	1
C	160 142	Tube fitting, straight	6.4 - 8 mm ID	PTFE	1
D	107 811	Tube fitting, straight	2 - 3 mm ID	PP	1
E	107 812	Tube fitting, straight	3 - 4 mm ID	PP	1
F	107 813	Tube fitting, straight	4 - 6 mm ID	PP	1
G	107 814	Tube fitting, straight	5 - 7 mm ID	PP	1
H	107 816	Tube fitting, straight	6.2 - 7.5 mm ID	PP	1
I	107 817	Tube fitting, straight	9.5 - 11 mm ID	PP	1
J	107 808	Tube fitting, angled	6.4 - 8 mm ID	PP	1
K	107 810	Tube fitting, angled	9.5 - 10 mm ID	PP	1

Accessories

Adapters for the tube connector



**Flexible like no other -
The tube connector**

Our adapters offer numerous connections.

L 160 141



M 160 132



N 160 137



O 160 129



P 160 131



Q 160 130



R 160 128



S 117 819



T 117 821



Fig.	Part No.	Description	For tube diameter		Material	Unit
-	160 506	Blind plug for tube connector	-		PTFE	1
L	160 141	2-in-1 collector	2.3 / 3.2 mm OD		PTFE / PFA	1
-	160 144	2-in-1 collector	2.3 / 3.2 mm OD		PTFE	1
M	160 132	3-in-1 collector	2.3 / 3.2 mm OD		PTFE / PFA	1
N	160 137	8-in-1 collector	2.3 mm OD		PTFE / PFA	1
O	160 129	8-in-1 collector	2.3 mm OD (7x)	6.4 mm ID (1x)	PTFE / PFA / PP	1
P	160 131	3-in-1 collector, angled	2.3 / 3.2 mm OD		PTFE / PFA / PP	1
Q	160 130	3-in-1 collector, angled	2.3 / 3.2 mm OD (2x)	6.4 mm ID (1x)	PTFE / PFA / PP	1
R	160 128	3-in-1 Sammler, straight	6.4 mm ID (3x)		PTFE / PP	1
S	117 819	Tube fitting, straight, + sealing nut	8 mm ID		PTFE	1
T	117 821	Tube fitting, straight, + sealing nut	6.5 mm ID		PTFE	1