

OPERATOR'S MANUAL

AUTOCLAVE

ES-215, ES-315

*Before starting operation, read this Operator's Manual thoroughly for a complete understanding of the autoclave and its correct handling.

*Be sure this Operator's Manual is within easy reach and is secure so that the operator can consult it at any time.

Research Use Only

TOMY SEIKO CO.,LTD.

TABLE OF CONTENTS



1.	FOR SAFE OPERATION	P. 2
	1-1. WARRANTY INFORMATION	P. 2
	1-2. WARNING/CAUTION	P.3
2.	OUTLINE AND FEATURES OF DEVICE	P.6
	2-1. OPERATING PRINCIPLE	P. 6
	2-2. NAME AND FUNCTION OF EACH PART	P.7
3.	INSTALLATION	P.11
	3-1. RELOCATION AND INSTALLATION	P.11
	3-2. POWER SUPPLY CONNECTION AND PROPER GROUNDING(EARTHING)	P.12
4.	FLOW OF OPERATION	P.13
5.	HOW TO OPERATE	P. 14
	5-1. TURNING ON/OFF THE POWER SUPPLY SWITCH	P. 14
	5-2. OPENING /CLOSING THE CHAMBER LID	P. 15
	5-3. CHECKING THE PRESSURE GAUGE	P. 16
	5-4. CHECKING THE EXHAUST BOTTLE	P. 16
	5-5. CHECKING THE STERILIZING WATER	P. 17
	5-6. PLACING THE MATERIAL TO BE STERILIZED	P. 18
	5-7. SELECTING THE OPERATING MODE	P. 20
	5-8. SETTING THE OPERATING CONDITIONS	P. 21
	5-9. STARTING THE OPERATION	P. 22
	5-10. COMPLETING THE OPERATION	P. 23
	5-11. REMOVING THE STERILIZED MATERIAL	P. 23
	5-12. DRAINING THE STERILIZING WATER	P. 24
6.	CONVENIENT FUNCTIONS	P. 25
	6-1. STERILIZING/WARMING MODE	P. 25
	6-2. HEATING MODE	P. 27
	6-3. MEMORY FUNCTION	P. 28
	6-4. TIMER FUNCTION	P. 29
7.	MAINTENANCE AND ADJUSTMENT	P. 30
	7-1. CLEANING AND DISINFECTING THE MAIN UNIT	P. 30
	7-2. REPLACING BELLOWS	P. 31
	7-3. WEEKLY MAINTENANCE	P. 32
8.	TROUBLESHOOTING	P. 34
	8-1. PROBLEMS AND COUNTERMEASURES	P. 34
	8-2. ERROR CODE TABLE	P. 35
	8-3. TO CONTACT US	P. 36
9.	SPECIFICATIONS	P. 37
	9-1. SPECIFICATIONS OF DEVICE	P. 37

1. FOR SAFE OPERATION



Inside the TOMY Autoclave ES-215/315 is subject to very high temperature and pressure conditions during operation. Therefore, should the autoclave be incorrectly installed or operated, there might be potentially hazardous situation that could cause death or serious injury to the operator and laboratory personnel or damage to property. Read this operator's manual thoroughly for a complete understanding of the autoclave and its correct handling before operating the instrument.

1-1.WARRANTY INFORMATION

For proper and safe use of this product, precautionary notes are inserted with signs to draw your attention as shown below. Safety alert symbols are classified into "WARNING" and "CAUTION" depending on the level of potential injury to personnel or damage to property.

 Warning	Mishandling of the instrument by ignoring this note may cause death or severe injury to the user.
 Caution	Mishandling of the instrument by ignoring this note may cause injury to the user or cause physical damage to property.

<Pictorial symbols>

	Indicates prohibition (actions which must not be carried out). Specific contents are indicated using a picture or sentence near the symbol.
	Indicates enforcement (actions that shall be carried out). Specific contents are indicated using a picture or sentence near the symbol.

1-2.WARNING/CAUTION

Warning



Do not modify the instrument or any associated parts.

- Doing so may cause serious accident or malfunction.



Do not use parts other than those specified by TOMY.

- Doing so may cause serious accident or malfunction.



Do not allow any foreign articles to fall inside the instrument.

- Doing so can cause short circuit, fire, or malfunction. These may occur when metal fittings, flammable material, or water enters through air vents or exhaust openings.



Do not open the instrument cover to avoid touching the inner part of the instrument.

- Doing so may cause electric shock, burns, fire, or malfunction.



Do not touch the power plug with wet hands.

- Doing so may cause electric shock to the user.



Do not operate the instrument when the power cable or plug is damaged or the plug is not firmly connected to the outlet.

- Doing so may cause fire, short circuit or breakdown due to ignition.



Do not put a heavy item onto the power cord.

- Doing so may cause fire, short circuit or breakdown due to ignition.



Do not pull the power cord by force.

- Doing so can cause fire or breakdown due to disconnection.



Unplug the power plug from the outlet when the instrument is not to be used for a prolonged time.

- Failure to do so may result in electric shock, short circuit, or fire due to deterioration of insulation. For models with no power plug provided, turn off the breaker to which the power cord is connected.



Do not install the instrument in a place where chemicals such as flammable or corrosive gases are stored.

- Doing so can cause fire, short circuit, or electric shock due to corrosion of electrical parts.



Do not install the instrument in a dusty or wet place.

- Doing so can cause short circuit or ignition of electrical parts.



Do not install the instrument near a sink, a water pipe or in a place where there is a risk of it being splashed with water.

- Doing so can cause short circuit or electric shock.



Install the instrument on a firm and level surface such as a concrete floor.

- Failure to do so may result in injury to personnel or physical damage to property due to upsetting of the instrument.



Plug the power cord singly into an electric outlet with the specified voltage.

- Failure to do so can cause fire, short circuit or malfunction due to ignition.



Do not extend the power cord.

- Doing so can cause fire, short circuit or malfunction.



Be sure to ground the instrument.

- Failure to do so can cause explosion, electric shock or malfunction.



Do not use a gas pipe or water pipes for protective grounding.

- Doing so can cause explosion, electric shock or malfunction.



Do not touch the power switch with wet hands.

- Doing so may cause electric shock to the user.



Never open the chamber lid unless the pressure has returned to 0 kPa and the temperature is below 97 °C.

- Opening the lid while inflationary pressure remains in the chamber can cause death or serious accident due to the blowout of sterilized articles or steam.

Warning

Use caution when opening the chamber lid.

• Failure to do so may cause burns or injury because the steam emanating from inside chamber has an extremely high temperature.

Stop operating the instrument when the pressure gauge is not working normally.

• If the operating conditions inside chamber cannot be monitored correctly with the pressure gauge, it can cause hazardous situations. Contact your dealer or the nearest TOMY office for repairs.

Do not open the front door while the instrument is running to avoid touching inside front panel.

• Doing so may cause burns as inside front panel is superheated. Improper operation of the instrument may also cause the blowout of the hot water or steam and result in hazardous situations.

Do not bend the exhaust hose.

• Doing so may result in the abnormal increase of pressure inside chamber because the air exhaustion can not be carried out smoothly. It can cause damage to parts, burns, injury or serious accident due to explosive breakage.

Do not put inflammable or explosive substance inside the instrument.

• Doing so can cause fire or explosion.

Do not sterilize sealed materials.

• Doing so may result in an explosion of super-heated material when it is removed from the chamber and cause burns or serious accident. It may also result in the abnormal increase of pressure inside chamber and can cause damage to parts, burns or serious accident due to explosive breakage.

Do not sterilize glass equipments having cracks or scratches.

• Doing so may result in an explosion of glass equipment when it is removed from the chamber and cause burns or serious accident

Do not operate the instrument without storing the material to be sterilized in the chamber basket (a stainless steel basket with slatted bottom plate).

• If the basket is not used, it may cause an explosion of the chamber as the exhaust hole is blocked by such materials as a sterilizing bag and the pressure inside the chamber cannot be controlled.

Make sure the chamber lid is securely closed before starting operation.

• Failure to do so may cause burns as the unexpected hot steam is escaping through space between the lid and the chamber unit.

Immediately stop running the instrument when the pressure enters the red zone on the indicator gauge during operation.

• Failure to do so may cause damage to the instrument parts or burns and serious accident. Turn off the instrument immediately and contact your dealer or the nearest TOMY office for an inspection.

When operating the instrument in constant run mode, take more than 10 minutes interval between running after the chamber temperature drops to 60 or below.

• Failure to do so may result in an explosion that can cause burns or injury or damage to the instrument parts as the pressure inside the chamber rises abnormally high.

Use extreme caution when handling autoclaved liquids since they are hot and may suddenly boil over.

• The temperature of autoclaved liquids falls more slowly than the temperature inside chamber. Superheated liquids may suddenly boil when moved or touched. An eruption may result in burns or serious accident.

Do not leave inside the chamber or sterilizing water contaminated.

• Doing so can cause corrosion or damage to the chamber. It may also cause malfunction of the water level sensor to prevent the chamber from heating with no or low water inside and fire can be occurred by blankheating.

When executing maintenance sequences, be sure to unplug the instrument first to avoid electric shock.

• For models with no power plug, turn off the breaker to which the power cord is connected.

Stop running the instrument if corrosion, damage or deformation is found in the chamber, chamber lid, lid arm or lid arm guide.

• Failure to do so can cause death, injury or serious accident due to the explosion of the chamber while pressure is rising. If any abnormality is found in the chamber unit, contact your dealer or the nearest TOMY office.

Warning

 **Stop running the instrument if such damage as cracks or leaks is found on the chamber lid gasket.**

• Failure to do so can cause burns to the user as the hot steam escapes through the crack. Contact your dealer or the nearest TOMY office for an inspection.

 **Do not unnecessarily pull the lid gasket out of the chamber lid or deform it.**

• Doing so can cause burns to the user due to the hot steam escaping through the lid.

 **Clean and decontaminate the instrument or the parts before returning it to your dealer or TOMY, shipping it back for service, or allowing a service technician to repair it whenever the condition 1 or 2, given below, applies.**

1. All or some part of this product or components has been exposed to infectious and hazardous materials or radioactive products.
2. All or some part of this product or components, when blood or chemicals are pooled in some way inside, has been judged to be dangerous to human health.

Caution

 **Be careful of superheated steam coming from the steam exhaust hole during operation.**

• Failure to do so can cause burns to the user.

 **Do not drain until the sterilizing water cools down sufficiently.**

• Doing so can cause burns as the temperature of the sterilizing water is very high after running.

 **When executing maintenance sequences, make sure that the temperature inside the chamber falls down sufficiently.**

• Failure to do so can cause burns to the user.

2. OUTLINE AND FEATURES OF DEVICE

The TOMY Autoclave ES-215/315 (high-pressure steam sterilizer) is an apparatus used for sterilizing materials with saturated steam under a pressure above atmospheric pressure.

2-1. OPERATING PRINCIPLE

After starting operation, the TOMY Autoclave ES-215/315 heats the sterilizing water inside the chamber with the element heater at the bottom of the chamber unit. The steam generated by heating water drives air out from the chamber and warms inside the chamber. When the temperature sensor inside the chamber detects that the set sterilization temperature is reached, that temperature is maintained for the specified time. The residual air inside the chamber is driven out during this process cycle. When the heating process continues, the valve is closed in response to a rise in the temperature and the chamber temperature and pressure continue rising.

When the temperature sensor detects that the chamber temperature is reached at the set temperature, the timer is activated and the set temperature is maintained for the specified time until the sterilizing time has elapsed. The sterilizing action is determined by the three elements: temperature, humidity and time applied to the material to be sterilized during this process.

When the set sterilizing time has elapsed, the element heater stops. The valve opens in response to a fall in the chamber temperature and the chamber pressure returns to the atmospheric level. When the temperature sensor detects that the chamber temperature falls to 60°C, it is indicated by a buzzer sound and the indicator lamp that all sterilizing cycle has been finished

If any abnormality is found in the instrument performance, it is indicated by both the error code message on the display and a buzzer sound while the instrument goes to a safer functional status.

2-2. NAME AND FUNCTION OF EACH PART

MAIN UNIT

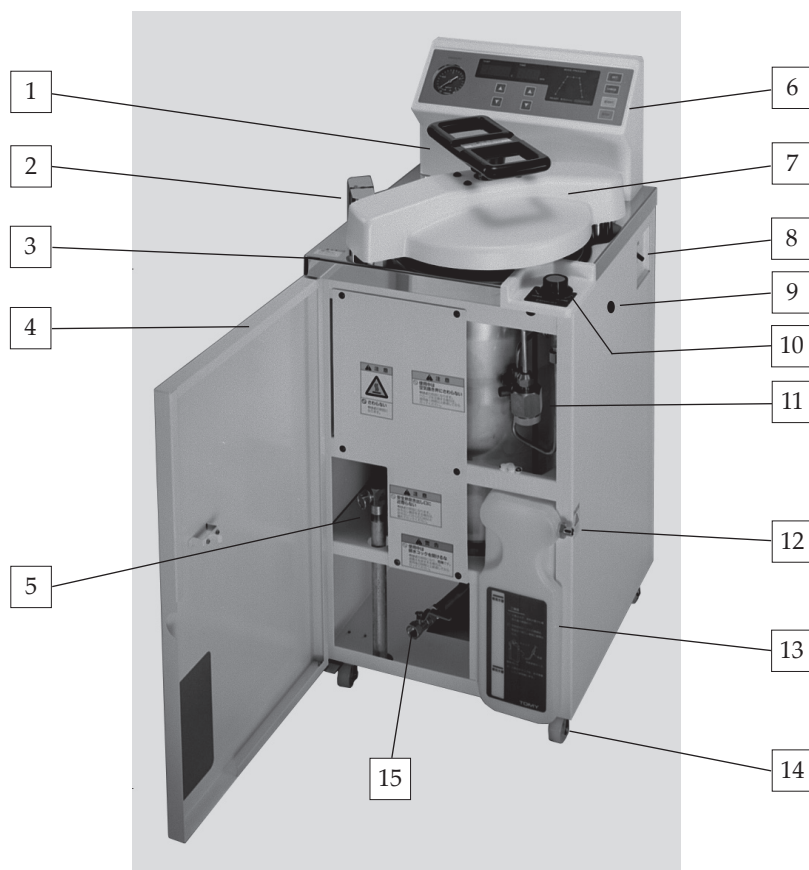

1. Chamber lid handle

It is used to open/ close the chamber lid.

2..Chamber lid arm guide

It supports the chamber lid arm.

3. Top plate

It is a stainless outer covering the chamber opening.

4. Front door panel

It is a front door of the main unit.

5. Safety valve

It is used to reduce any abnormal pressure inside the chamber.

6. Control panel

It is used to set or select settings.

7. Chamber lid/Insulation cover

The chamber lid is opened or closed by sliding the lid handle to load the material to be sterilized.

The insulation cover is used to prevent hot burns to the user.

8. Power supply switch

The power supply switch with the leakage breaker is used to turn on/off the main unit.

9. Mount for accessory case

For string the operation manual .

ES-215 : only left side of the main unit

ES-315 : each side of the main unit

10. Exhaust valve knob

It is used to close the exhaust valve before starting a run to keep the pressurized status of the autoclave

11. Air release valve

It is used to remove the residual air inside the chamber.

12. Steam exhaust outlet

Through the outlet air or steam from the exhaust bottle is escaped.

13. Exhaust bottle

It is used to recover and cool down the steam exhausted from the chamber.

14. Caster with stopper

It is used to facilitate moving and fixing of the autoclave.

15. Drain port

Through the port the sterilizing water inside the chamber is drained.

INSIDE THE CHAMBER

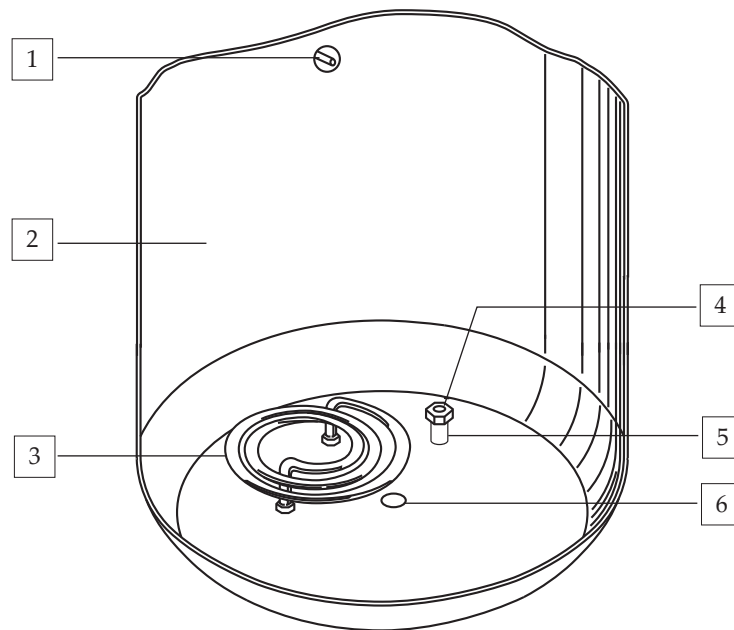

1. Temperature sensor

It is used to detect the temperature inside the chamber.

2. Chamber

It is the main unit of the pressure tank.

3. Element heater

It is used to heat the sterilizing water inside the chamber.

4. Water level sensor

It is used to detect the level of chamber water.

5. Water level sensor base

It supports the water level sensor.

6. Drain hole

Through the hole the sterilizing water is exhausted from the chamber to the drain port.

PIPING DIAGRAM

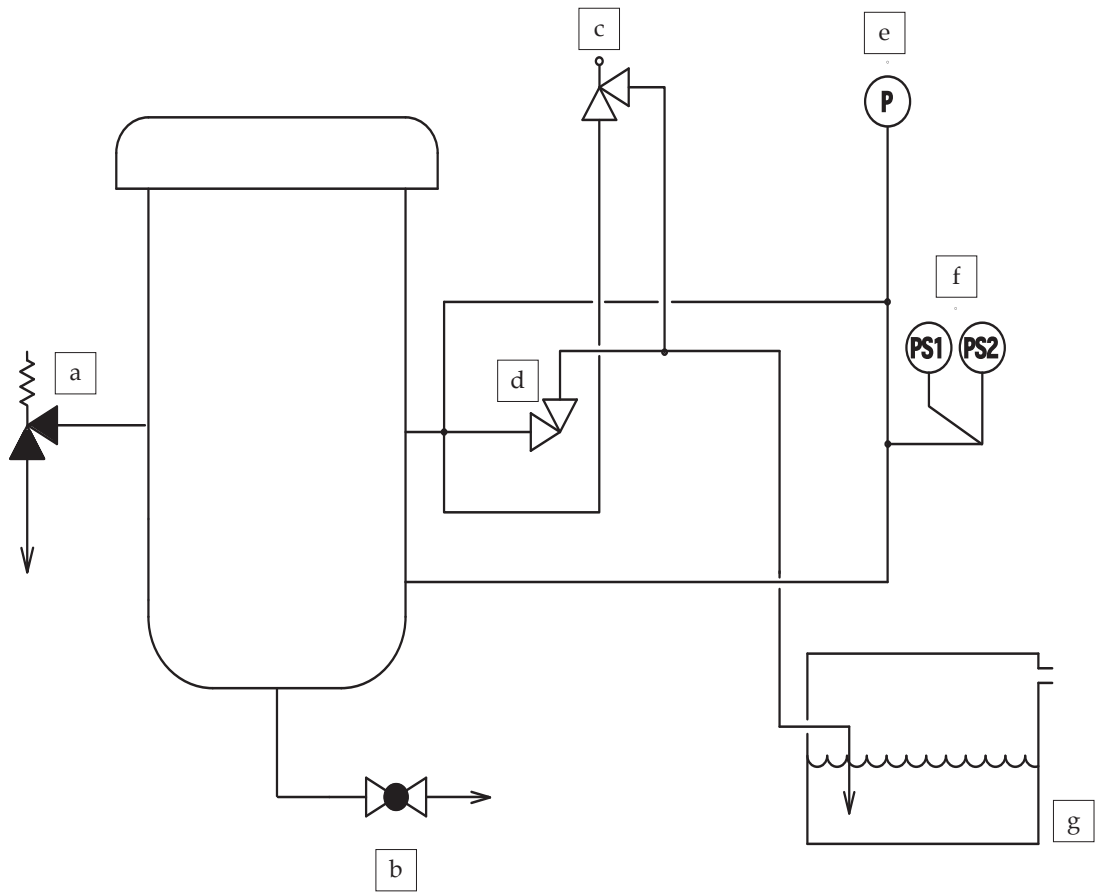

- a. Safety valve
- b. Ball valve
- c. Exhaust valve
- d. Air release valve
- e. Pressure gauge
- f. Pressure switch
- g. Exhaust bottle

CONTROL PANEL

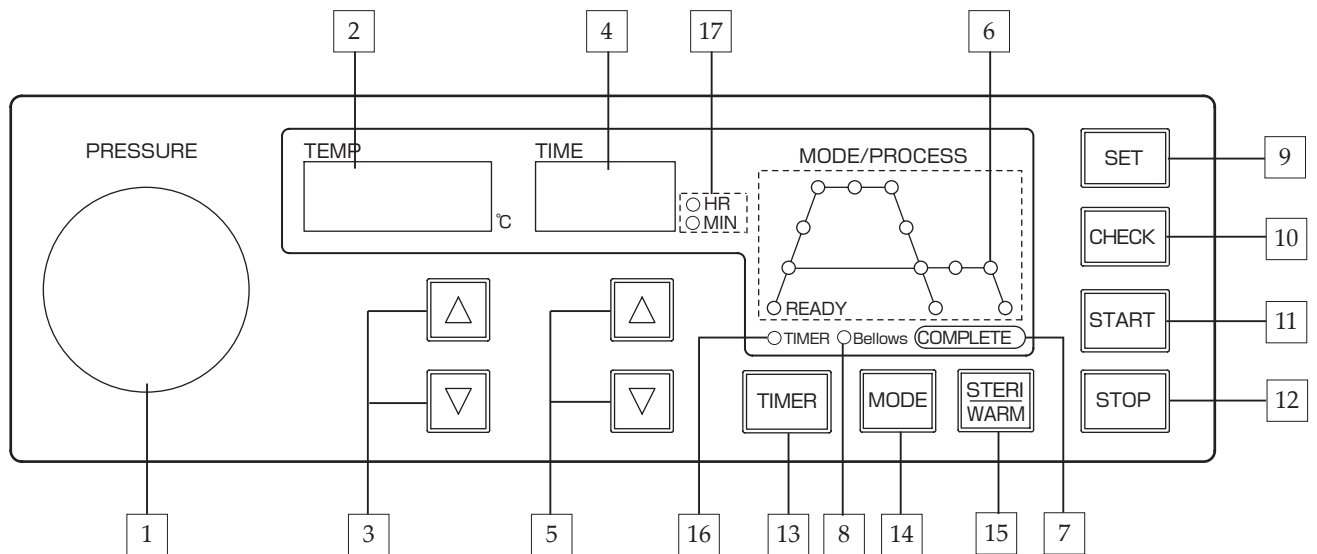

1. Pressure gauge

It displays the pressure inside the chamber.
 <Display range>
 ES-215: 0 – 250 kPa
 ES-315: 0 – 400 kPa

2. Temperature/Error message display

While the autoclave is being energized for preparation, it displays the set temperature. During operation it displays the temperature inside the chamber or the set temperature while the check key is being pressed.

3. Temperature setting <UP/DOWN ARROW>keys

Press these keys to increase or decrease the set temperature for the selected cycle.
 <Setting range>
 ES-215: 105 – 123 for sterilizing process
 55 – 95 for warming/heating process
 ES-315: 105 – 132 for sterilizing process
 55 – 95 for warming/heating process

4. Time display

While the autoclave is being energized for preparation, it displays the pre-set time for the selected cycle. During operation it displays the remaining time of each operation cycle or the set time for each selected cycle while the check key is being pressed. While the start-timer is activated, it displays the time remaining for completion of cycle.

<Display range>
 ES-215: 1 – 240min. continuous, for sterilizing process
 1 – 8hours for warming/heating process
 ES-315: 1 – 240min. continuous, for sterilizing process
 1 – 8hours for warming/heating process

5. Time setting <UP/DOWN ARROW>keys

Press these keys to increase or decrease the set time for the selected cycle or the start-timer.
 <Setting range>
 ES-215: 1 – 240min. continuous, for sterilizing process
 1 – 8hours for warming/heating process
 ES-315: 1 – 240min. continuous, for sterilizing process
 1 – 8hours for warming/heating process
 <Setting range for start-timer>
 1– 99hours (1 hours increment)

6. Mode/Process LED indicator

It graphically displays the set mode selected or indicates each stage of operation cycle.

7. Complete LED indicator

When all the set mode selected are completed, the buzzer will sound and the complete LED will flash.

8. Bellows LED indicator

It indicates the operation status or the optimum replacement time of the air bellows inside the air release valve by lighting or flashing red/green lamp.

9. <SET> key

Press this key to memorize the set temperature and time.

10. <CHECK> key

To check the set conditions of the autoclave, press this key to indicate the pre-set temperature and time on the respective display.

11. <START> key

Press this key to start operation.

12. <STOP> key

Press this key to stop operation

13. <TIMER> key

Press this key to display the set time for the start-timer.

14. <MODE> key

Press this key to select the three modes of operation:sterilizing, sterilizing/warming, and heating.

15.<STERI/WARM> key

When the sterilizing/warming mode is selected, press this key to switch between sterilizing and warming.

16.Timer LED indicator

This indicator lights up while setting the start-timer and flashes while activating it.





17. <HR/MIN> LED indicator

The <MIN> indicator flashes while setting or operating the sterilizing process. The <HR> indicator flashes while setting or operating the warming/heating process or the start-timer.

3. INSTALLATION

3-1. RELOCATION AND INSTALLATION

Warning

-  **Do not install the instrument in a place where such chemicals as flammable or corrosive gases are stored.**
 - Doing so can cause fire or short circuit and electric shock due to the corrosion of electrical parts.
-  **Do not install the instrument in a dusty or wet place**
 - Doing so can cause short circuit or ignition of electrical parts.
-  **Do not install the instrument near a sink, a water pipe or in a place where there is a risk of it being splashed with water.**
 - Doing so can cause short circuit or electric shock.
-  **Install the instrument on a firm and level surface such as a concrete floor.**
 - Failure to do so may result in injury to personnel or physical damage to property due to upsetting of the instrument.

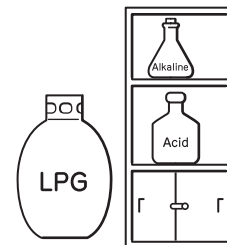

<Relocation and Installation>

(1) Hold the top plate of the unit with both hands and gently move the instrument



(2) Select the right location for the instrument that is not exposed to direct sunlight and is well ventilated. Install the instrument allowing 100mm or more of extra space behind the instrument. Leave sufficient space at the front and the right side of the instrument.

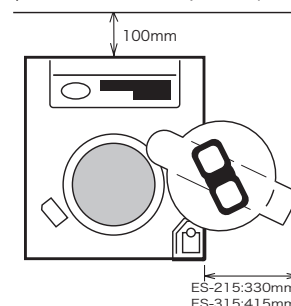

(3) Fix the caster rollers at the bottom of the instrument with the attached stoppers.

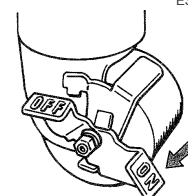

(4) Attach the clear plastic accessory case for storing the operator's manual using the attachment screw for clear plastic accessory case.
• After reading the operator's manual, store it carefully in the clear plastic accessory case.

<Operating Environmental Requirements>

When operating the instrument, observe the environmental requirements given below.

Temperature Range:	5 to 35
Relative Humidity:	30 to 85%
Atmospheric Pressure:	700 to 1060hPa
Maximum gradient:	2 °

3-2. POWER SUPPLY CONNECTION AND PROPER GROUNDING (EARTHING)

⚠ Warning

❗ **Plug the power cord singly into an electric outlet with the specified voltage.**

- Failure to do so can cause fire, short circuit or malfunction due to ignition.

⊘ **Do not use power cable extensions.**

- Doing so can cause fire, short circuit or malfunction due to ignition.

❗ **Be sure to provide protective grounding for the instrument.**

- Failure to do so may result in explosion, electric shock or malfunction.

⊘ **Do not use a gas pipe or water pipes for protective grounding.**

- Doing so can cause explosion, electric shock or malfunction.

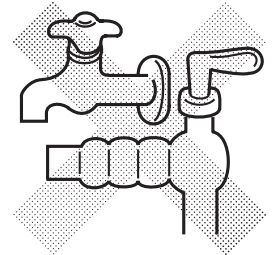
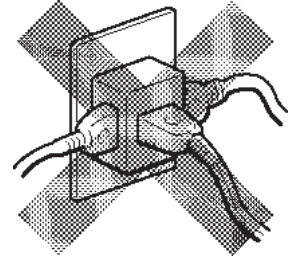

Grounding electrical equipment is required to protect against electric shock. When grounding cannot be provided, request specialists for an adequate grounding for the instrument

Just plug the provided power cord directly and singly into the outlet to meet the conditions given below:

Power supply conditions:

- ES-215 ; single-phase 120VAC (50/60 Hz), 15A or more
- single-phase 220VAC (50/60 Hz), 15A or more
- single-phase 230VAC (50/60 Hz), 15A or more
- single-phase 240VAC (50/60 Hz), 15A or more
- ES-315 ; single-phase 120VAC (50/60 Hz), 20A or more
- single-phase 220VAC (50/60 Hz), 15A or more
- single-phase 230VAC (50/60 Hz), 15A or more
- single-phase 240VAC (50/60 Hz), 15A or more

*The electrical voltage of the power outlet should be consistent with the rated voltage of the instrument. The rated voltage of the instrument is shown on the product nameplate label.

Protection against electrical shock is provided by connecting wire on the plug for grounding to the grounding terminal.

*If it begins to thunder, pull the power plug out of the power outlet to avoid having damage from the lightning.

4. FLOW OF OPERATION

1. Turning on the power switch	P.14
2. Checking the pressure gauge	P.16
3. Checking the exhaust bottle	P.16
4. Checking the sterilizing water	P.17
5. Placing the material to be sterilized	P.18
6. Selecting the operation mode	P.20
7. Setting the operation conditions	P.21
8. Starting the operation	P.22
9. Completing the operation	P.23
10. Removing the sterilized material	P.23
11. Draining the sterilizing water	P.24
12. Turning off the power switch	P.14

*When operating the instrument in a constant run mode, check the pressure gauge before restarting operation after removing the sterilized material from the chamber.

5. HOW TO OPERATE

5-1. TURNING ON/OFF THE POWER SUPPLY SWITCH

Warning



Do not touch the power supply switch with wet hands.

- Doing so can cause electric shock to the user.

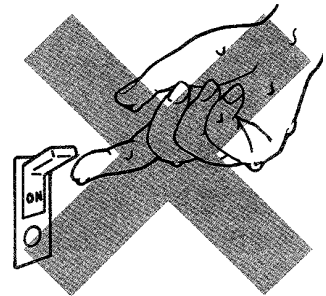

<Turning ON the power supply switch>



- (1) Before turning on the instrument, make sure that the power supply is properly connected and the protective grounding is provided.
- (2) Turn on the power switch located on the right side of the main unit. The control panel will light and display preset values of each parameter and the LED indicators will flash and show the instrument is ready for operation.

<Turning OFF the power supply switch>

- (1) Turn off the power switch on the right side of the main unit.

5-2. OPENING/CLOSING THE CHAMBER LID

Warning

-  **Never open the chamber lid until the chamber temperature falls to 97 °C or less at the pressure of 0kPa.**
 - Opening the chamber lid while inflationary pressure remains inside can cause death or serious accident due to blowout of the sterilized material or the steam from the chamber..
-  **Use caution when opening the chamber lid, as the steam from the chamber is hot.**
 - Failure to do so can cause burns or injury

<Opening the chamber lid>

(1) Before opening the chamber lid, make sure that pressure inside the chamber is 0kPa and chamber temperature is 97°C or less.

(2) Open exhaust valve by turning counterclockwise to exhaust the steam from the chamber.

(3) Open chamber lid by slowly turning the lid handle counterclockwise and sliding it horizontally to the right.

*If the lid insulation cover is exposed to hot, humid air over a long period of time, it may be subject to damage. Close chamber lid by sliding it to the left and slowly turn the handle clockwise until the lid gasket touches the chamber opening.

<Closing the chamber lid>

(1) Hold the handle and close the chamber lid by sliding it to the left until it stops when the lid arm hits the arm guide.

(2) Turn the lid handle clockwise. As its turning gets tight, give an additional one quarter turn.

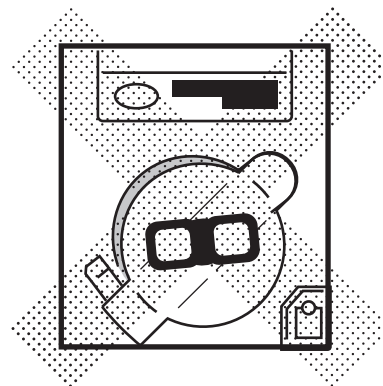
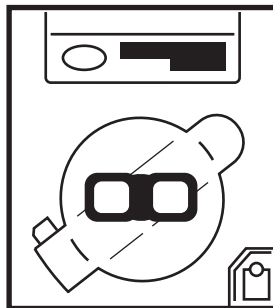

5-3. CHECKING THE PRESSURE GAUGE

Warning



Stop operating the instrument when the pressure gauge is not working normally

• If the operating conditions inside chamber cannot be monitored correctly with the pressure gauge, it can cause hazardous situations. Contact your dealer or the nearest TOMY office for repairs

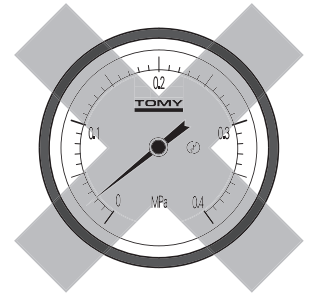

<Checking the pressure gauge>

- (1) Open the chamber lid.
- (2) Make sure that the pressure gauge reads "0kPa".

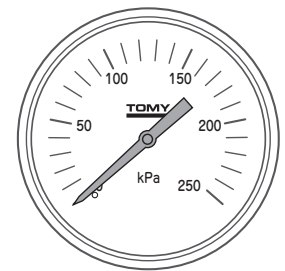

5-4. CHECKING THE EXHAUST BOTTLE

Warning



Do not open the front door panel during operation.

• Doing so may cause burns as inside front panel is superheated. Improper operation of the instrument may also cause the blowout of the heated water or steam and result in hazardous situations.



Do not bend the exhaust hose.

• Doing so may cause abnormal increase of the pressure inside chamber as the air exhaustion is not carried out smoothly. It may result in damage to parts, burns, injury or serious accident from the blowout.

This instrument exhausts high-temperature steam from the chamber during operation. Therefore, check the level of water for cooling steam in the exhaust bottle to avoid accidents such as burns.

<Checking the exhaust bottle>

- (1) Make sure that the level of water in the exhaust bottle is between the marks of the lowest and highest level. Fill water if needed according to the following procedure:
- (2) Turn the unit off at the main switch after confirming that the temperature inside chamber is cool enough.
- (3) Open the front door panel and remove the exhaust bottle slowly from the main unit.
- (4) Hold the joint of the exhaust hose and slowly pull it out from the exhaust bottle.
- (5) Remove the cap on the top of the bottle and fill water from the fill / drain port to the minimum level.
- (6) Push the cap on the fill / drain port and push the end of the exhaust hose into the back of the bottle.
- (7) Mount the bottle slowly on the storage shelf of the main unit.
- (8) Close the front door panel.

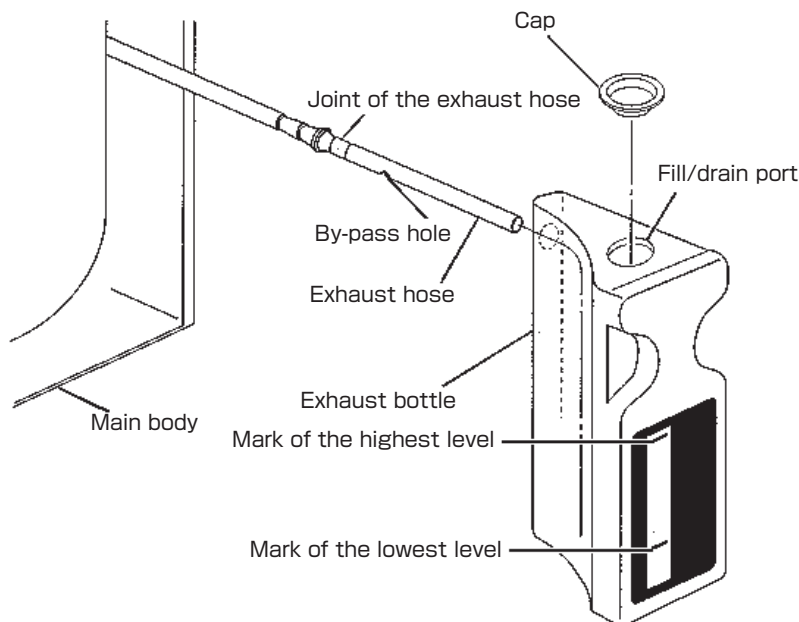

5-5. CHECKING THE STERILIZING WATER

This instrument generates steam by heating the sterilizing water inside chamber. Check the quality and the level of the chamber water for proper sterilization.

<Checking the sterilizing water>

- (1) Open the chamber lid and make sure the chamber water is not contaminated.
 - (2) When the chamber water is contaminated, drain it.
- *See 5-12. DRAINING THE STERILIZING WATER for further reference.
- (3) Check the level of water reaches the bottom plate of the chamber basket (stainless steel wire mesh basket).

*When sterilizing with a large volume of liquid in the bucket, fill tap water until the bottom of the bucket is soaked in water approximately 5 cm above the bottom of the bucket.

- (4) Add tap water if needed, until the water level reaches the bottom plate of the chamber basket.

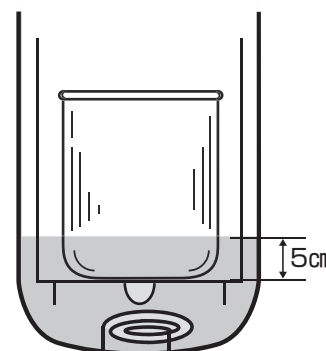

<Guide for the level of the sterilizing water>

ES-215: approximately 1.5 L

ES-315: approximately 3.0 L

5-6. PLACING THE MATERIAL TO BE STERILIZED

Warning

 **Do not put inflammable or explosive substance inside the instrument.**

- Doing so can cause fire or explosion.

 **Do not sterilize sealed materials.**

- Doing so may result in an explosion of super-heated material when it is removed from the chamber and cause burns or serious accident. It may also result in the abnormal increase of pressure inside chamber and can cause damage to parts, burns or serious accident due to explosive breakage.



 **Do not sterilize glass equipments having cracks or scratches.**

- Doing so may result in an explosion of glass equipment when it is removed from the chamber and cause burns or serious accident.

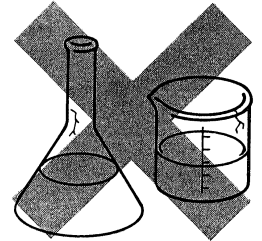

 **Do not operate the instrument without storing the material to be sterilized in the chamber basket (stainless steel wire mesh basket).**

- If the basket is not used, it may cause an explosion of the chamber as the exhaust hole is blocked by such materials as a sterilizing bag and the pressure inside the chamber cannot be controlled.

 **Make sure the chamber lid is securely closed before starting operation.**

- Failure to do so may cause burns as the unexpected hot steam is escaping through space between the lid and the chamber unit.

<Placing the material to be sterilized>

- (1) Place materials to be sterilized in the provided stainless basket or in an optional stainless bucket.
- (2) Place the material slowly in the chamber.
- (3) Close the chamber lid.
- (4) Close the exhaust valve securely by turning the exhaust valve knob clockwise until tight.

<For more efficient sterilization>

When the form of the material to be sterilized prevents air from escaping, it may allow some air to remain inside the chamber and lessen the effect of sterilization. Therefore, it is recommended that the countermeasures given below be taken in order for complete sterilization to take place:

- When sterilizing material in a sterilizing bag, fill the bag with approximately 100ml of water and keep the top of the bag open as widely as possible.
- When sterilizing material in a container, fill the container with a little water (10 to 50ml).
- Adjust the volume of material to be sterilized to the chamber capacity.

When sterilizing material stored in a container with a low-permeability, the container may be deformed and the effect of sterilization may be lessened. Therefore, it is recommended that the countermeasures given below be taken in order for complete sterilization to take place:

- Before starting sterilization, remove or loosen the cap of the container.
- Exchange the cap of the container with the one with higher permeability.
- Make a vent hole at the bottom of the container.

When a plastic article is sterilized, it may be deformed. Therefore, it is recommended that the plastic article be sterilized referring to the table given below:

Table. Adaptation of each material to sterilization process

Adaptation	Polyethylene	Polypropylene copolymer	Polypropylene	Polycarbonate	Teflon FEP
Use of autoclave	Not allowed	Allowed (121°C)	Allowed (121°C)	Caution needed	Allowed (121°C)
Feedwater ratio (%)	0.02 or less	0.02 or less	0.03 or less	Approximately 0.03	0.01 or less
Transparency	Opaque	Half transparent	Half transparent	Transparent	Half transparent

※ The above table should be referred as a guide. Note that characteristics will vary depending on the pressure, temperature, time, etc.

○ Table. Temperature and gauge pressure of saturated steam

Temperature(°C)	Gauge pressure(kPa)
105	19.6
110	42.0
115	67.8
120	97.3
121	103.7
125	130.9
130	168.9
132	185.5

5-7. SELECTING THE OPERATING MODE

In the sterilizing mode, it provides a standard sterilizing operation. In the sterilizing-warming mode, it provides a sterilizing operation and warming operation after sterilizing cycle is completed. In the heating mode, it provides a heating operation under 95°C.

By pressing the MODE key, the three operating modes; sterilizing, sterilizing-warming, and heating mode will appear in order. Select the desired mode by pressing the MODE key.

When the mode is changed, the MODE/PROCESS display lamp will light to indicate the selected mode and the instrument will beep two times. When turning on the power, the sterilizing mode is selected.

STERILIZING MODE

It provides a sterilizing operation.

It allows setting of the temperature and time for the sterilizing process.

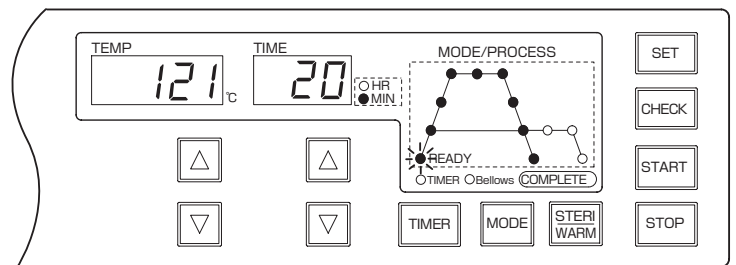

STERILIZING-WARMING MODE

It provides a sterilizing operation and a warming operation after sterilizing process is completed.

It allows setting of temperature and time for both the sterilizing and warming processes.

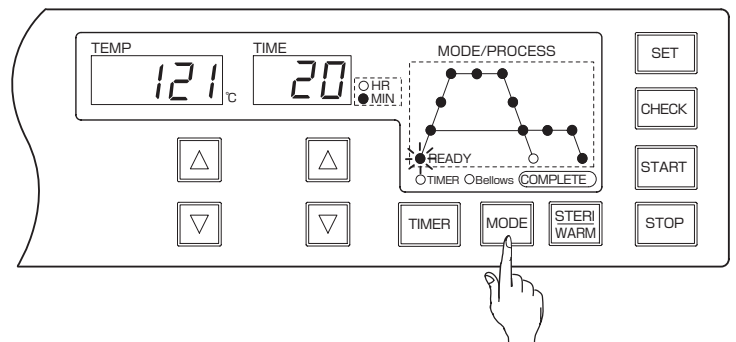

HEATING MODE

It provides a heating operation under 95°C.

It allows setting of the temperature and time for the heating process.

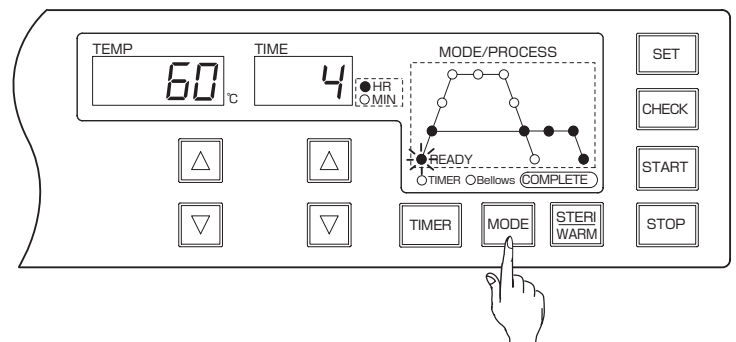

<Selecting the sterilizing mode>

(1) Press the MODE key to select the sterilizing mode.

5-8. SETTING THE OPERATING CONDITIONS

<Setting the conditions of the sterilizing operation>

Example: Setting the sterilizing temperature and times to 115°C and 60 minutes

(1) Check the panel display to ensure that the sterilizing mode is selected.

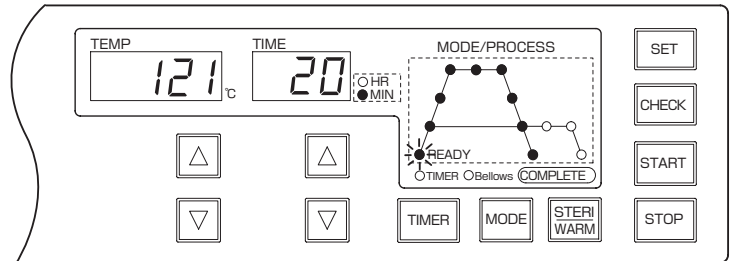

(2) Set the temperature and time for the sterilizing process by pressing each setting key.

*While setting the conditions, three indication lamps on the panel display flash in red.

1. Temperature setting range	ES-215: 105 - 123°C ES-315: 105 - 132°C
2. Time setting range	1 - 240 min, continuous

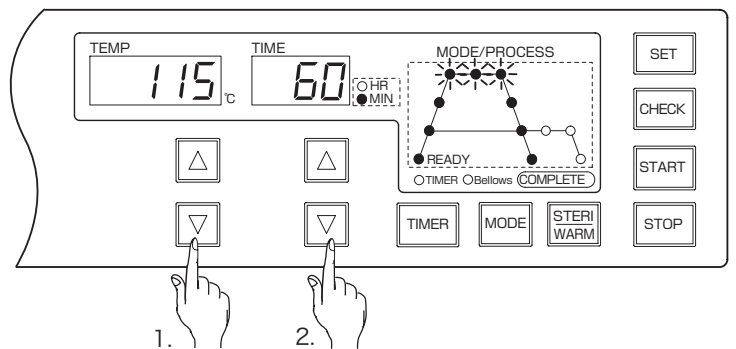

*The time setting means to set the length of time that inside the chamber will remain at the set temperature.

(3) When completing the setting of the operating conditions, release the key.

*The indicator will show READY by a blinking LED.

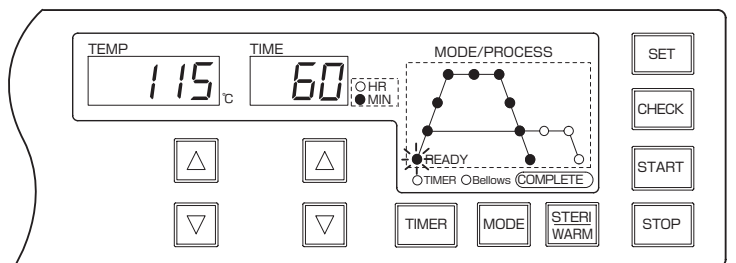

<For an efficient sterilization>

When sterilizing large volume of liquid, it will take a longer time to raise the chamber temperature. Therefore, it is recommended the operating time be extended referring to the table given below:

Table. Guide for extended sterilizing time for liquid sterilization (reference example: sterilization temperature and times, 121°C and 20 minutes.)

2L of water:(20 min) + 4min
5L of water:(20 min) + 8min
10L of water:(20 min) + 15min

This instrument controls the temperature with a temperature sensor inside the chamber as an index. When more reliable sterilization is required, set proper sterilizing conditions using a temperature sensor placed inside the material to be sterilized or such index as a sterilization indicator.

5-9. STARTING THE OPERATION

Warning



Do not open the front door panel during operation.

- Doing so can cause burns to the user as inside the front panel will become very hot during operation. It may also result in a blowout of hot water and steam due to the mishandling of the instrument.



Stop running the instrument immediately when the pressure enters the red zone on the indicator gauge during operation.

- Failure to do so can cause damage to the parts, burns or serious accident due to the breakage of the parts. Turn off the instrument immediately and contact your dealer or the nearest TOMY office.



When operating the instrument in a constant run mode, take more than 10 minutes interval between running after the chamber temperature drops to 60°C or below.

- Failure to do so may result in an explosion that can cause burns or injury or damage to the instrument parts as the pressure inside the chamber rises abnormally high.

Caution



Be careful of superheated steam coming from the steam exhaust hole during operation.

- Failure to do so can cause burns to the user.

(1) Press the START key.

The MODE/PROCESS display LED will light and indicate each stage of the sterilizing cycle as the chamber temperature rises and the sterilization time has passed.

*When pressing the START key right after turning on the power switch, an error message may appear on the display. After turning on the power, wait for at least 10 seconds before pressing the START key.

*During operation the temperature and the time display will indicate the chamber temperature and the time remaining respectively.

*When the CHECK key is pressed during operation, the display will switch to the set temperature and time and keep indicating the set values by holding down the key.

*If a blackout occurs during operation, the instrument will stop the operation and return to the initial setting mode (the sterilizing mode) when the power is turned on. Restart the selection of operating mode.

5-10. COMPLETING THE OPERATION

Immediately or shortly after completion of the operation, a sudden and explosive boiling may occur and can cause burns to the user. Therefore, it is recommended that the chamber lid be opened after the cooling process is over and the whole sterilizing cycle is completed

<Completing the operation>

- (1) When the set sterilization time has elapsed and the sterilizing cycle is completed, the instrument will beep 3 times.
- (2) When the chamber temperature falls to 97°C and the sterilizing operation is completed, the instrument will beep 6 times.
- (3) When the chamber temperature falls to 60°C and the cooling cycle is completed, the instrument will beep 10 times and the whole sterilizing cycle will be completed.

*Operation can be interrupted by pressing the STOP key.

*When operation is interrupted, the operating cycle will shift to the cooling cycle.

5-11. REMOVING THE STERILIZED MATERIAL

Warning



Never open the chamber lid unless the pressure has returned to 0 kPa and the temperature is below 97 °C.

- Opening the lid while inflationary pressure remains in the chamber can cause death or serious accident due to the blowout of sterilized articles or steam.



Use caution when opening the chamber lid.

- Failure to do so may cause burns or injury because the steam emanating from inside chamber has an extremely high temperature.



Use extreme caution when handling autoclaved liquids since they are hot and may suddenly boil over.

- The temperature of autoclaved liquids falls more slowly than the temperature inside chamber. Superheated liquids may suddenly boil when moved or touched. An eruption may result in burns or serious accident.



Do not leave inside the chamber or sterilizing water contaminated.

- Doing so can cause corrosion or damage to the chamber. It may also cause malfunction of the water level sensor to prevent the chamber from heating with no or low water inside and fire can be occurred by blankheating

<Removing the sterilized material>

(1) Make sure that the chamber pressure has returned to 0 kPa and the temperature is below 97°C before opening the chamber lid.

Immediately or shortly after completion of the operation, sudden boiling eruptions may occur and cause burns to the user. Therefore, it is recommended that the chamber lid be opened after the cooling process is over and the whole sterilizing cycle is completed.

(2) Open the chamber lid.

(3) Remove the sterilized material from the chamber.

*If inside the chamber or the chamber water is contaminated, clean it by referring to 7. MAINTENANCE AND ADJUSTMENT.

(4) When inside the chamber is still hot, close the chamber lid by sliding it to the left and slowly turn the handle clockwise until the lid gasket touches the chamber opening.

5-12. DRAINING THE STERILIZING WATER

⚠ Caution



Do not drain until the sterilizing water cools down sufficiently.

- Doing so can cause burns as the sterilizing water is very hot right after running.

<Draining the sterilizing water>

(1) Open the chamber lid.

(2) Slowly remove the basket (a stainless steel basket with slatted bottom plate) from the chamber.

(3) Make sure that the sterilizing water is sufficiently cooled down.

(4) Open the front panel door.

(5) Place the drain container below the drain port.

(6) Open the drain cock by turning it slowly and drain the sterilizing water from the drain port. When the sterilizing water is not drained due to clogs, clear them by inserting a wire etc. through the drain port.

(7) After draining off the sterilizing water, turn cock fully to close the drain port.

(8) Close the front door panel

(9) Slowly place the basket into the chamber.

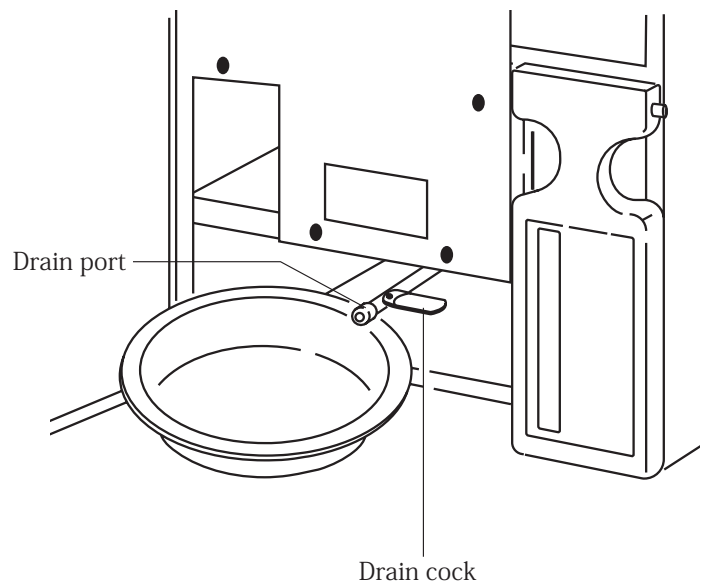

6. CONVENIENT FUNCTIONS

6-1. STERILIZING-WARMING MODE

<Operating sterilizing-warming function>

(1) When setting the operating conditions, press the MODE key to select the STERILIZING-WARMING MODE.

Example: Panel display of the sterilizing-warming mode (sterilization temperature and times, 115°C and 60 minutes, warming temperature and times, 55°C and 2 hours)

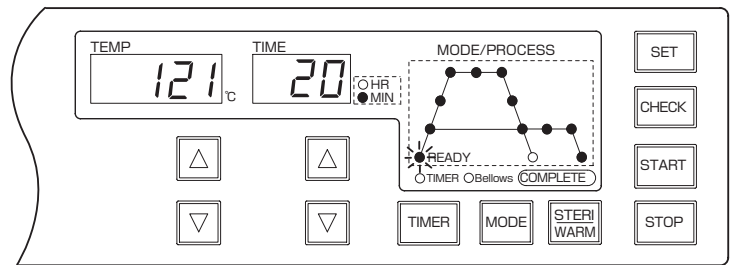

(2) Set the temperature and time for the sterilizing process by pressing each setting key.

1. Temperature setting range	ES-215: 105 - 123°C ES-315: 105 - 132°C
2. Time setting range	1 - 240 min, or continuously

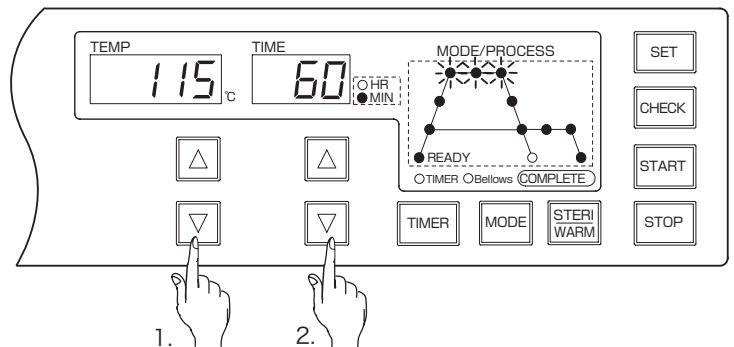

*While setting the conditions, three indication lamps on the panel display flash in red.

*The set time means the retention time for the set chamber temperature.

(3) After setting the sterilization temperature and time, the mode will change to the warming setting in three minutes. Set the temperature and time for the warming process by pressing each setting key.

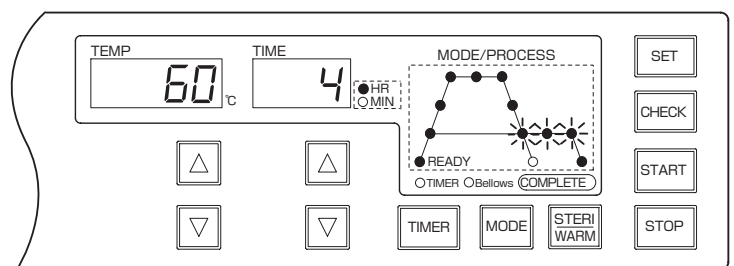

*The mode can also be changed to the warming setting by pressing the STERI/WARM key once without waiting for three seconds.

3. Temperature setting range	55 - 95°C
4. Time setting range	1 - 8 hours

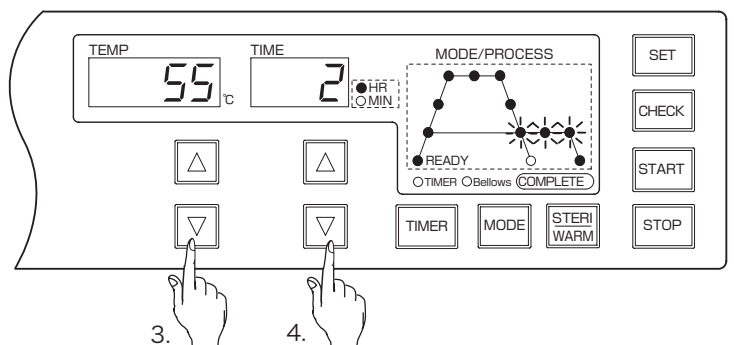

*While setting the conditions, three indication lamps on the panel display flash in red.

(4) When the setting of the operating conditions is completed, release the setting key.

*The indicator will show READY by a blinking LED in three seconds after releasing the key.

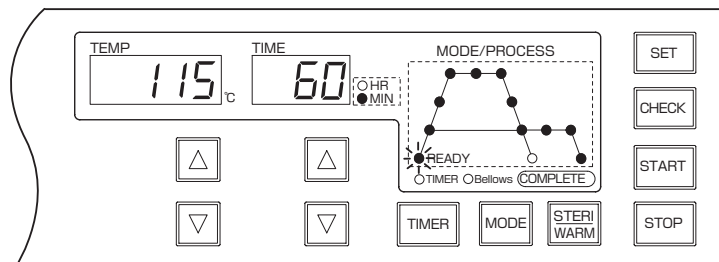

(5) Press the START key.

<Completing the sterilizing-warming function>

(1) When the set sterilizing time is over and the sterilizing cycle is completed, the instrument will beep 3 times.

*When turning the exhaust valve knob after completing the sterilizing process, an error message will appear on the display and the operation will stop.

(2) When the chamber temperature falls to 97°C and the sterilizing operation is completed, the instrument will beep 6 times.

(3) When the chamber temperature falls to the set warming temperature, the warming cycle will start.

(4) When the warming time is over and the warming cycle is completed, the instrument will beep 3 times.

(5) When the chamber temperature falls to 60°C and the cooling cycle is over, the instrument will beep 10 times and the whole operating cycle will be completed.

*When the warming temperature is set to 60°C or below, the buzzer will sound successively 3 times and 10 times after completing warming cycle and the whole operating cycle will be completed.

*Operation can be interrupted by pressing the STOP key.

*When operation is interrupted, the operating cycle will shift to the cooling cycle.

6-2. HEATING MODE

<Operating the heating function>

(1) When setting the operating conditions, press the MODE key to select the heating mode.

(2) Set the temperature and time for the heating process by pressing each setting key.

1. Temperature setting range	55 - 95°C
2. Time setting range	1 - 8 hours

*While setting the conditions, four indication lamps on the panel display flash in red.

*The set time means to the retention time for the set chamber temperature.

(3) When the setting of the operating conditions is completed, release the setting key.

*The indicator will show READY by a blinking LED in three seconds after releasing the key.

(4) Press the START key.

Example: Panel display of the heating mode (heating temperature and times, 85°C and 1 hour)

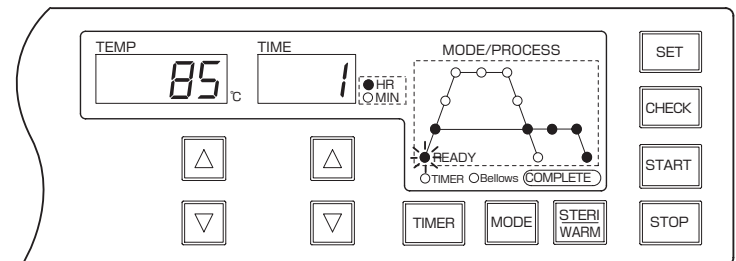
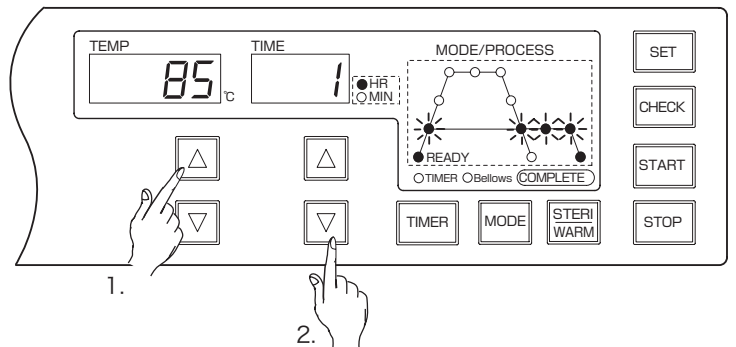
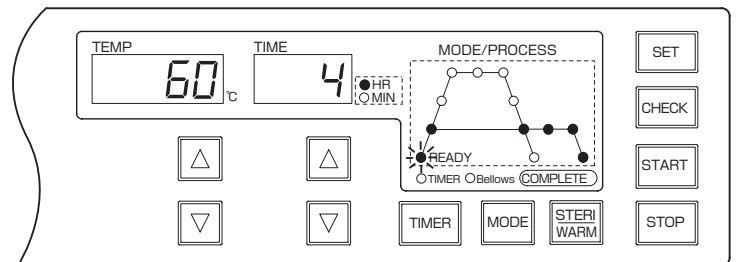

<Completing the heating function>

(1) When the set heating time is over and the heating cycle is completed, the instrument will beep 3 times.

(2) When the chamber temperature falls to 60°C and the cooling cycle is over, the instrument will beep 10 times and the whole operating cycle will be completed.

*Operation can be interrupted by pressing the STOP key.

*When operation is interrupted, the operating cycle will shift to the cooling cycle.

6-3. MEMORY FUNCTION

A memory function is provided to allow the user to store the value of operating conditions set in each function mode for a regular use.

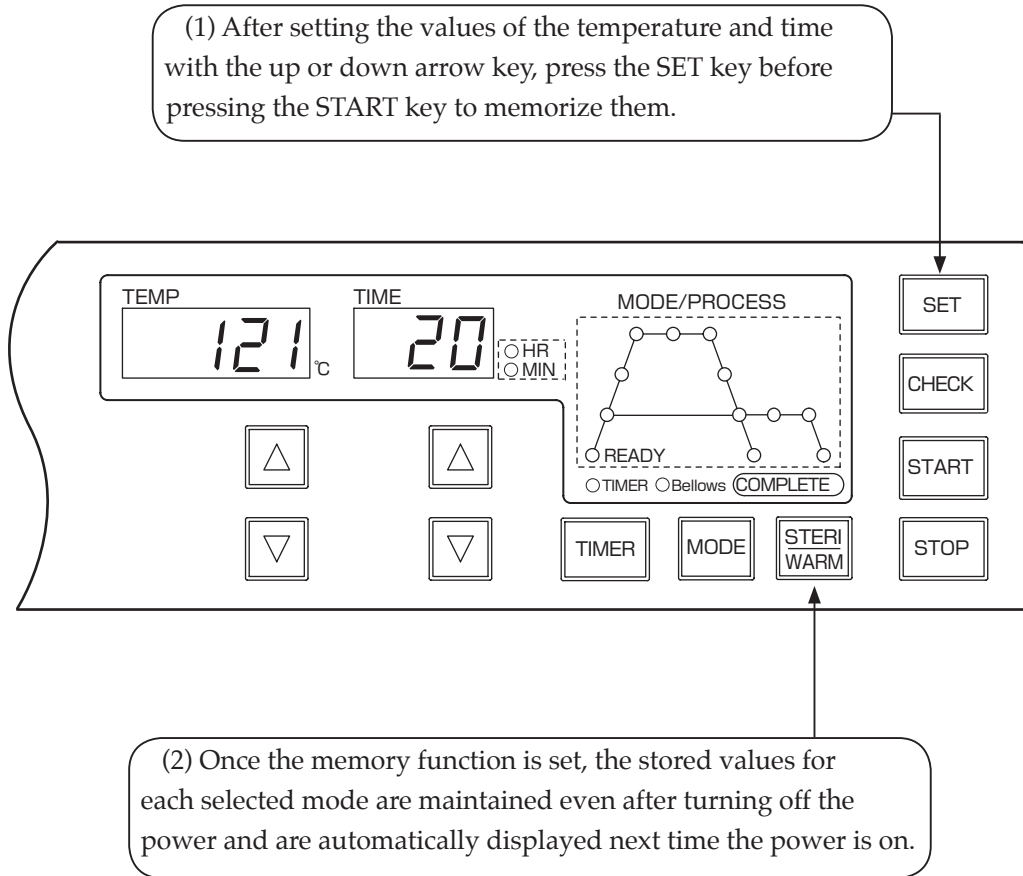

Table. Storable parameters of operating conditions for memory function

Sterilizing mode	A set of sterilizing temperature and time
Sterilizing-warming mode	Each set of sterilizing and warming temperature and time
Heating mode	A set of heating temperature and time

Table. Pre-set values of operating conditions at the time of shipment

Sterilizing mode	Sterilizing temperature and time, 121°C and 20 minutes
Sterilizing-warming mode	Sterilizing temperature and time, 121 °C and 20 minutes and Warming temperature and time, 60°C and 4 hours
Heating mode	Heating temperature and time, 60°C and 4 hours

6-4. TIMER FUNCTION

A timer function is provided to allow the user to set the waiting time for the operation to start for any time between 1 and 99 hours.

(1) Complete each setting of operating conditions for the desired mode.

(2) Press the TIMER key. The timer indication LED on the display will light and the waiting time can be set.

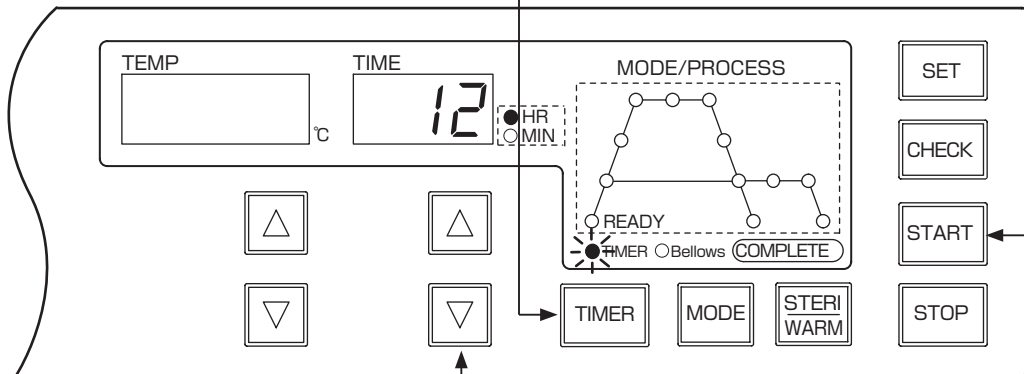

(3) Press the time setting up or down arrow key to set the waiting time within a range of 1 to 99 hours. Press the up or down arrow key once to increment or decrement the waiting time by one hour and hold down the key to continuously increase or decrease the time. The start timer indication LED lights while setting the timer.

(4) Press the START key. The timer indication LED on the display will flash and the timer will activate. When the waiting time is over, the instrument will start the desired mode operation.

○ To change the set operating conditions in each mode while setting the timer, Press the TIMER key once. The indication lamp on the control panel will change from TIMER to READY by a flashing LED and the setting of operating conditions can be changed. When change of operating conditions is completed, restart the timer setting.

○ To change the set operating conditions in each mode after starting the timer, Press the STOP key once. The indication lamp on the control panel will change from TIMER to READY by a flashing LED and the setting of operating conditions can be changed. When change of operating conditions is completed, restart the timer setting.

7. MAINTENANCE AND ADJUSTMENT

Warning

 **When executing maintenance sequences, be sure to unplug the instrument first to avoid electric shock.**

- For models with no power plug, turn off the breaker to which the power cord is connected.

Caution

 **When executing maintenance sequences, make sure that the temperature inside the chamber falls down sufficiently.**

- Failure to do so can cause burns to the user.

7-1. CLEANING AND DISINFECTING THE MAIN UNIT

When the outer panel or the inside the chamber is contaminated, perform cleaning and disinfecting in accordance with the following method:

<Cleaning the main unit>

- (1) Wipe exterior or interior of the unit with a soft cloth dampened in mild detergent.
- (2) Thoroughly wipe off all traces of the detergent with a tightly squeezed damp cloth.

<Disinfecting the main unit>

- (1) Disinfect the unit using ethanol.

7-2. REPLACING BELLOWS

When the Bellows indication lamp lights or flashes in red or green, replace bellows of air release valve.

*The Bellows indication lamp may also light or flash, when the volume of material to be sterilized is too much as compared to the size of the chamber. Check the volume of sterilizing material.

Status of bellows indication lamp	Operating status	Countermeasures
The green lamp flashes.	The pressure does not rise.	Replace bellows after the operation is completed.
The green lamp lights up.	The pressure does not rise.	Replace bellows after stopping the operation.
The red lamp flashes.	The pressure rises too high.	Replace bellows after the operation is completed.
The red lamp lights up.	The pressure rises too high.	Replace bellows after stopping the operation.

<Replacing the bellows>

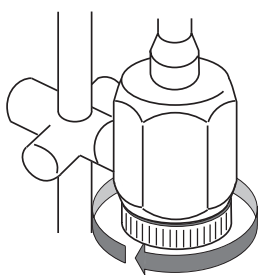

(1) Turn the bellows seat of the air release valve in the direction indicated by arrow. (See the above figure.)

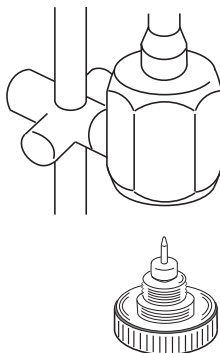

(2) Remove the bellows seat from the valve.

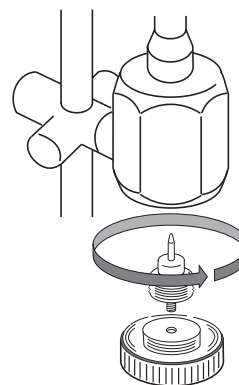

(3) Turn the bellows in the direction indicated by arrow and remove it from the seat. (See the above figure.) When dismantling the bellows, be careful not to lose the wave washer between the bellows and the seat.

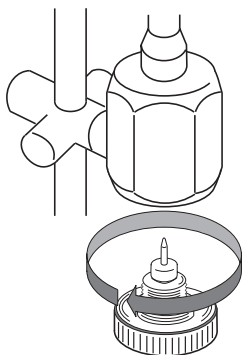

(4) Mount the new bellows through the wave washer and into the seat. Before mounting, make sure no foreign matter is attached to the gasket or the O-ring or no crack is found on their surfaces.

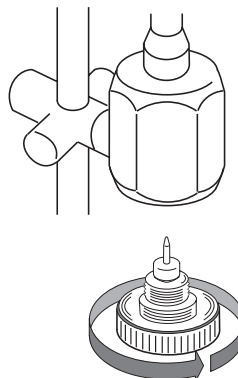

(5) Turn the bellows seat in the direction indicated by arrow to mount it into the air release valve. (As shown in the right figure.) Close the front door panel.

7-3. WEEKLY MAINTENANCE

Warning

- ! Stop running the instrument if corrosion, damage or deformation is found in the chamber, chamber lid, lid arm or lid arm guide.**

 - Failure to do so can cause death, injury or serious accident due to the explosion of the chamber while pressure is rising. If any abnormality is found in the chamber unit, contact your dealer or the nearest TOMY office.
- ! Stop running the instrument if such damage as cracks or leaks is found on the chamber lid gasket.**

 - Failure to do so can cause burns to the user as the hot steam escapes through the crack. Contact your dealer or the nearest TOMY office for an inspection.
- ⊘ Do not unnecessarily pull the lid gasket out of the chamber lid or deform it.**

 - Doing so can cause burns to the user due to the hot steam escaping through the lid.

For ensuring safe operation of the instrument, perform cleaning and inspection according to the following procedure as often as once a week.

<Cleaning>

1. Cleaning the inside the chamber and the water level sensor

(1) Remove the stainless steel basket with slatted bottom plate carefully out of the chamber.

(2) Thoroughly clean the inside the chamber and the water level sensor with mild detergent and cloth or other suitable material. Wash out the detergent with tap water and drain the water.

※ Be careful not to distort the sensors inside the chamber during cleaning.

(3) Turn the water level sensor counterclockwise with hands and remove it from the sensor base. When removing the sensor, be careful not to drop it into the chamber.

(4) Polish the water level sensor using household cleanser and a toothbrush or cloth until the silver plate surface appears. If the sensor is badly contaminated, polish it to clean with fine sandpaper (grit #400 to #800) or a file.

(5) After cleaning the water level sensor, turn it clockwise with hands and mount it into the sensor base and secure it. When mounting or dismounting the water level sensor, be sure to turn it manually and do not use pliers or any other tools

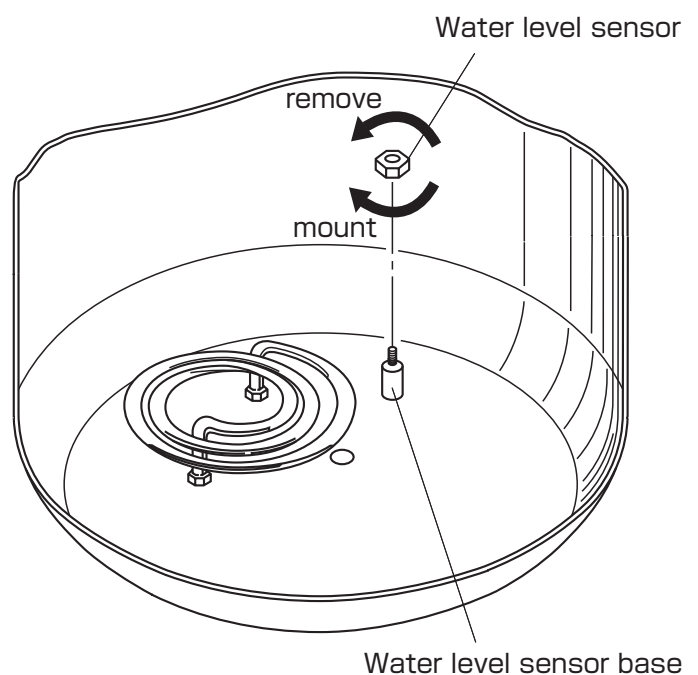

2. Cleaning the chamber lid gasket

- (1) Wipe surface of the chamber lid gasket thoroughly with a clean soft cloth with applying force.
- (2) Wipe opening of the chamber with a clean soft cloth.

3. Cleaning the outer panel

- (1) Wipe outer panel with a soft cloth dampened in mild detergent and then thoroughly wipe off all traces of the detergent with a damp cloth.

<Inspection>

1. Checking the leakage breaker

- (1) Turn on power at the main switch.
- (2) Press the red test button located inside the power switch with a slim rod.
- (3) When the switch is automatically turned off, the leakage breaker works normally. If not, contact your dealer or the nearest TOMY office.

2. Checking the pressure tank

- (1) Check the pressure tank for any damage or cracks.
- (2) Check the inside the chamber for any corrosion or damage such as cracks.
- (3) Check the chamber lid for any corrosion or damage such as cracks.
- (4) Check the lid arm and lid arm guide for any corrosion or damage such as cracks.

8. TROUBLESHOOTING

When the instrument does not operate normally even though operation is performed correctly according to this operator's manual, take the appropriate action referring to "Problems and countermeasures" stated below. If the problem cannot be solved after taking all measures that are suggested or the countermeasures seem to be difficult, unplug the power cord and contact your dealer or the nearest TOMY office

8-1. PROBLEMS AND COUNTERMEASURES

Problem	Probable Cause	Countermeasures
Nothing is displayed on the control panel after turning on power at the main switch.	The instrument is not correctly connected to the power supply outlet.	Plug the instrument properly.
	The fuse or breaker at the power supply side is blown or tripped.	Confirm the outlet is not overloaded and reconnect the instrument properly.
The temperature rises slowly.	The volume of the chamber water is extremely large.	Check the volume of chamber water and optimize the volume.
Sterilization is not carried out sufficiently.	The sterilizing time is insufficient.	Extend the sterilizing time.
Steam leaks from the safety valve.	Inner gasket is damaged or degraded.	Unplug the power cord and contact your dealer or the nearest TOMY office.
Steam leaks from the chamber lid.	The chamber lid is not securely closed.	Check the position of the chamber lid and turn the handle one quarter turn clockwise to close.
	Dusts are adhering to the chamber lid gasket or the chamber opening.	Clean the chamber lid gasket and the chamber opening.
Bellows indication lamp flashes or lights up.	Take the appropriate action referring to "Replacing the bellows".	
An error code is displayed and operation does not start or is interrupted.	Refer to the error code table and take appropriate actions corresponding to the relevant error code.	

8-2. ERROR CODE TABLE

Error code	Cause	Countermeasures
Er1	The sterilizing water is insufficient.	Add tap water.
	The water level sensor is contaminated.	Clean the water level sensor.
	Pure water is used for sterilizing water.	Use tap water for sterilizing water.
	The temperature of the sterilizing water is extremely low.	Press the CHECK key for approximately 30 seconds to increase the water temperature.
Er2	The exhaust valve is open.	Turn the exhaust valve knob clockwise to close the valve.
Er3	The temperature of the outer wall of the chamber is abnormally high during sterilizing.	Unplug the power cord and contact your dealer or the nearest TOMY office.
Er4	The volume of chamber water becomes insufficient during sterilizing.	Add sterilizing water after the chamber pressure falls 0kPa and the chamber temperature is 97°C or less.
Er5	The chamber temperature rises at least 5 °C higher than the setting value during sterilizing.	Unplug the power cord and contact your dealer or the nearest TOMY office.
Er6	The pressure rises abnormally as the form of materials to be sterilized prevents air from escaping.	Turn off the power switch temporarily and wait for the chamber pressure to return to 0kPa and open the chamber lid to release air from the sterilizing material or to reduce the volume of the material. (See 5-6. REPLACING THE MATERIAL TO BE STERILIZED.)
Er7	The temperature sensor has fractures.	Unplug the power cord and contact your dealer or the nearest TOMY office.
Er8	The volume of the material to be sterilized is too much.	Open the chamber lid and reduce the volume of the material after the chamber pressure returns to 0kPa.
	The heater has fractures.	Unplug the power cord and contact your dealer or the nearest TOMY office.
Er9	The chamber lid is not securely seated in the chamber arm guide.	Reopen the lid and then close it firmly in place.
Er0	There are several potential causes stated above for the error.	Identify causes applying to the error referring to the above stated error codes from Er 1 to 9, and take appropriate actions corresponding to the relevant error codes.

8-3. TO CONTACT US

Warning

 **Clean and decontaminate the instrument or the parts before returning it to your dealer or TOMY, shipping it back for service, or allowing a service technician to repair it whenever the condition 1 or 2, given below, applies.**

1.All or some part of this instrument or components has been exposed to infectious and hazardous materials or radioactive products.

2.All or some part of this instrument or components, as blood or chemicals are pooled in some way inside, has been judged to be dangerous to human health.

For Assistance or Service Contact ;

TOMY SEIKO CO.,LTD.

TOMY DIGITAL BIOLOGY CO., LTD.

“EDGE”Building

2-9-1 Ikenohata, Taito-ku, Tokyo 110-0008, Japan

e-mail : info@digital-biology.co.jp

URL : <http://www.digital-biology.co.jp>

phone : +81-3-5834-0810 fax : +81-3-5834-1888

Financial Department

3-14-17 Tagara, Nerima-ku, Tokyo 179-0073, Japan

TOMY TECH U.S.A.,INC.

40479 Encyclopedia Circle,

Fremont California 94538, U.S.A.

e-mail : info@tomytech.com

phone : 510-440-1976 fax : 510-440-1975

Toll-Free US & Canada : 800-545-TOMY

9. SPECIFICATIONS

9-1. SPECIFICATIONS OF DEVICE

Model Name	ES-215	ES-315
Operating temperature range (during sterilizing)	105 - 123°C	105 - 132°C
Operating pressure range	0 - 127 kPa	0 - 186 kPa
Maximum operating pressure	147 kPa	216 kPa
Temperature control	Digital, microprocessor controlled	
Temperature display/display range	Digital/ - 15 - 180°C	
Pressure display/display range	Analog/ 0 - 250 kPa	Analog/ 0 - 400 kPa
Heat source	1.5 kW electric heater	2.0 kW electric heater
Time control	Digital, microprocessor controlled	
Time display	Digital	
Time display range		
Sterilizing mode:	1 - 240 min. or continuous	
Sterilizing-warming mode:	1 - 240 min. (steriligin)/1 - 8 hours (warming)	
Heating mode:	1 - 8 hours	
Start-timer setting range	1 - 99 hours in each operation mode	
Memory function	A set of temperature and time setting in each operation mode	
Safety devices	<ul style="list-style-type: none"> ● Inside the chamber overheat prevention ● Outer wall of the chamber overheat prevention ● Overpressure prevention ● Temperature sensor disconnection prevention ● Empty heating prevention ● Leakage breaker ● Safety valve 	
Malfunction prevention devices	<ul style="list-style-type: none"> ● Low water level detection ● Exhaust valve knob open/close detection ● Insufficient sterilization detection ● Chamber lid open/close detection 	
Leakage breaker		
Rated breaking current:	20 A (120V) , 15 A (220/230/240V)	30 A (120V) , 15 A (220/230/240V)
Rated sensed current:	30 mA (120V) , 10 mA (220/230/240V)	30 mA (120V) , 10 mA (220/230/240V)
Protection type	Class I equipment	
Operating environment		
Ambient temperature:	5 - 35°C	
Relative humidity:	30 - 85%	
Atmospheric pressure:	700 - 1060 hPa	
Gradient:	Within 2°	
Dimensions/capacity of chamber	ϕ 248 × 543mm/ 25 ℓ	ϕ 325 × 740mm/ 59 ℓ
Chamber material	SUS304	
Capacity/material of exhasut bottle	3 ℓ /polyethylene	
Type/material of lid gasket	Accommodating internal pressure/silicone rubber	

Model Name	ES-215	ES-315
Dimensions of main unit (mm)	400W × 460D × 920H (Height from floor to control panel:705)	490W × 560D × 1090H (Height from floor to control panel:875)
Net weight	50kg	80kg
Rated Voltage	AC 120/220/230/240V	
Power input	15A (120V) , 7A (220/230/240 V)	20A (120V) , 10A (220V) , 9A (230/240V)
Power supply requirements	Single-phase 120 V AC (50/60Hz) 15A or above	Single-phase 120 V AC (50/60Hz) 20A or above
Accessories	Stainless steel basket with slatted bottom plate	1
	Bellows Ass' y	1
	Water level sensor	1
	Inspection sheet	1
	Warranty card	1
	Customer card	1
	Operator' s manual	1
	Clear plastic accessory case	1
	Attachment screw for clear plastic accessory case	1
	Stainless basket (φ 230 × 390mm)	1

TOMY SEIKO CO.,LTD.

TOMY DIGITAL BIOLOGY CO.,LTD.

“EDGE” Building

2-9-1 Ikenohata, Taito-ku, Tokyo 110-0008, Japan

e-mail : info@digital-biology.co.jp

URL : <http://www.digital-biology.co.jp>

phone : +81-3-5834-0810

fax : +81-3-5834-1888

TOMY TECH U.S.A.,INC.

40479 Encyclopedia Circle,

Fremont California 94538, U.S.A.

e-mail : info@tomytech.com

phone : 510-440-1976 fax : 510-440-1975

Toll-Free US & Canada : 800-545-TOMY